

**CONTENTS**

INTRODUCTION .....P 5

INSTALLATION .....P 7

STANDARD CONNECTIONS .....P 9

GETTING STARTED .....P 11

PLAYING A DVD-VIDEO DISC .....P 12

PLAYING A VIDEO CD .....P 16

PLAYING AN AUDIO CD .....P 18

SETTINGS .....P 20

PARENTAL CONTROL .....P 22

BEFORE REQUESTING SERVICE .....P 23

**DVD-VIDEO**

**THE ENTERTAINMENT MEDIUM FOR THE MILLENIUM**

Video was never like this before! Perfect digital studio-quality pictures with truly 3-dimensional digital multichannel audio. Story sequences screened from your own choice of camera angle.

Language barriers broken down by sound tracks in as many as eight languages, plus subtitles - if available on disc - in as many as 32. And whether you watch DVD-Video on wide-screen or regular TV, you always see it the way it was meant to be.

**DIGITAL VIDEO**

DVD-Video uses state-of-the-art MPEG2 data compression technology to register an entire movie on a single 5-inch disc. DVD's variable bitrate compression, running at up to 9.8 Mbits/second, captures even the most complex pictures in their original quality.

The crystal-clear digital pictures have a horizontal resolution of over 500 lines, with 720 pixels (picture elements) to each line. This resolution is more than double that of VHS, superior to Laser Disc, and entirely comparable with digital masters made in recording studios.

DVD-Video discs conform to either the PAL or NTSC video standard. This dual-standard player can play both types, and present them in the best possible way on your multistandard TV screen.

As the universal video system of the future, DVD-Video offers optimal pictures on any TV screen.

# INTRODUCTION

## INTRODUCTION

Your Philips DVD-Video player plays digital video discs conforming to the universal DVD-Video standard. With it, you will be able to enjoy full-length movies with true cinema picture quality, and stereo or multichannel sound (depending on the disc, and on your playback set-up). The unique features of DVD-Video, such as selection of sound track and subtitle languages, and of different camera angles (again depending on the disc), are all included. What's more, Philips Parental Control lets you decide which discs your children will be able to see.

You will find your player remarkably easy to use, by way of the On-Screen Display and player display, in combination with the remote control.

In addition to DVD-Video discs, you will also be able to play all Video CDs and audio CDs. The disc types which run on the player feature one or more of these logos on the disc packaging:



## PLACEMENT

- Place the player on a firm, flat surface.
- Keep away from domestic heating equipment and direct sunlight.
- In a cabinet, allow about 2.5 cm (1 inch) of free space all around the player for adequate ventilation.

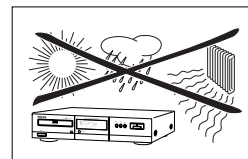

- If the DVD-Video player fails to read discs correctly use a commonly available cleaning CD/DVD to clean the lens before taking the DVD-Video player for repair. Avoid other cleaning methods, which may destroy the lens. Always keep the tray closed to avoid dust on the lens.
- The lens may cloud over when the DVD-Video player is suddenly moved from cold to warm surroundings. Playing a CD/DVD is not possible in such a situation. Leave the DVD-Video player in the warm environment until the moisture evaporates.

## UNPACKING

First check and identify the contents of your DVD-Video player package, as listed below:

- DVD-Video player
- Remote Control Handset with separately-packed batteries
- 2-core power cord
- Euroconnector cable
- User Manual

If any item should be damaged or missing, please inform your supplier without delay.

Keep the packaging materials; you may need them to transport your player in the future.

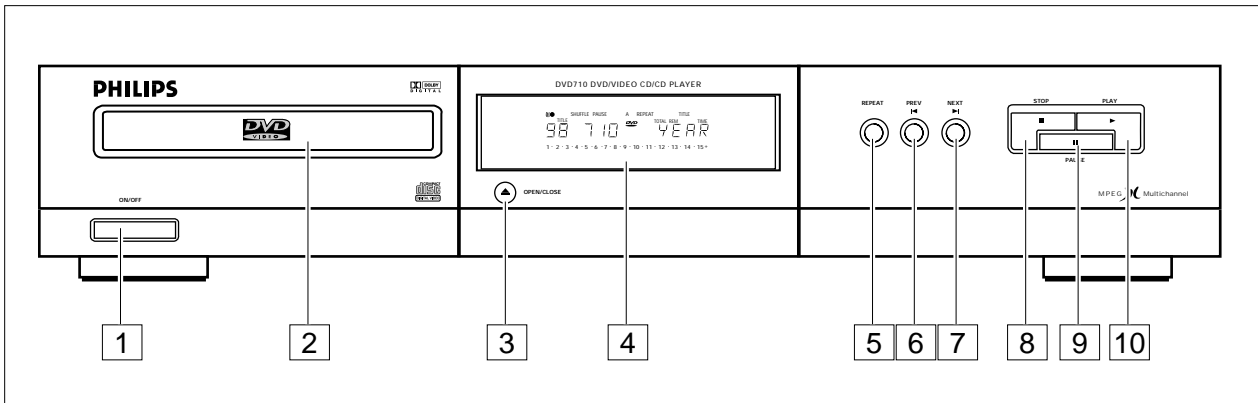

## FRONT OF PLAYER

- 1 ON/OFF
- 2 Disc tray
- 3 Tray OPEN/CLOSE
- 4 Display
- 5 REPEAT/chapter/track/title/disc
- 6 ◀ PREVIOUS title/chapter/track
- 7 ▶ NEXT title/chapter/track
- 8 ■ STOP
- 9 || PAUSE/Still/Step
- 10 ▶ PLAY

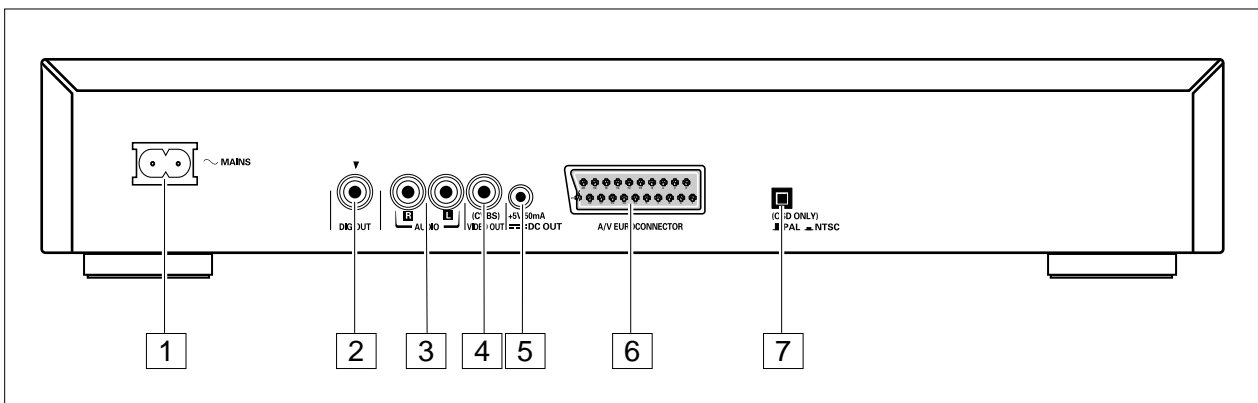

## REAR OF PLAYER

- 1 Power supply
- 2 Digital audio output
- 3 Audio R; Audio output R  
Audio L; Audio output L
- 4 Video (CVBS); Video output
- 5 DC Power output (for optional external RF modulator)
- 6 A/V Euroconnector
- 7 NTSC/PAL switch (for player menus)

**CAUTION**  
Do not touch the inner pins of rear-panel connectors.  
Electrostatic discharge may cause permanent damage to the unit.

# INSTALLATION

## DISPLAY

- 1 Remote control active (flashing)
- 2 FTS (Favourite Track Selection) active
- 3 SHUFFLE active
- 4 PAUSE active
- 5 SCAN active
- 6 A-B REPEAT/CHAPTER/TITLE/TRACK mode active
- 7 Chapter or track calendar
- 8 TOTAL/REMaining/TRACK TIME in hours, minutes and seconds
- 9 (V)CD disc inserted
- 10 DVD disc inserted
- 11 DVD CHAPTER or VCD/CD TRACK number
- 12 DVD TITLE number

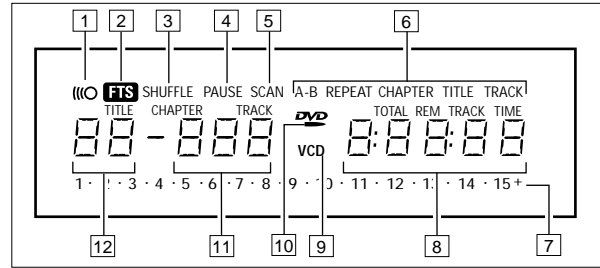

## REMOTE CONTROL

- 1 **OSD** .....(On-Screen Display) on/off
- 2 **ANGLE** .....select DVD camera angle  
**SUBTITLE** .....language selector or subtitle on/off  
**AUDIO** .....spoken language selector
- 3 **0-9**.....numerical key pad
- 4 **T-C** .....title/chapter mode selector
- 5 **MENU** .....select DVD-defined menu  
**OK**.....acknowledge menu selection.  
 up/down/left/right cursor movement
- 6 **◀◀ ◀** .....previous chapter or track / search back  
**▶▶ ▶** .....next chapter or track/ search forward  
**▶**.....play  
**⏸** .....pause or still frame /step frame  
**▶** .....slow motion (1/2, 1/4, 1/8 speed)  
**■**.....stop
- 7 **SETUP** .....select player settings menu (in stop mode only)  
**REPEAT\*/A-B REPEAT** chapter, track, title, disc  
**SHUFFLE/SCAN\*** shuffle or scan on/off
- 8 **RETURN**.....go back to previous menu step
- 9 **⏻** .....standby

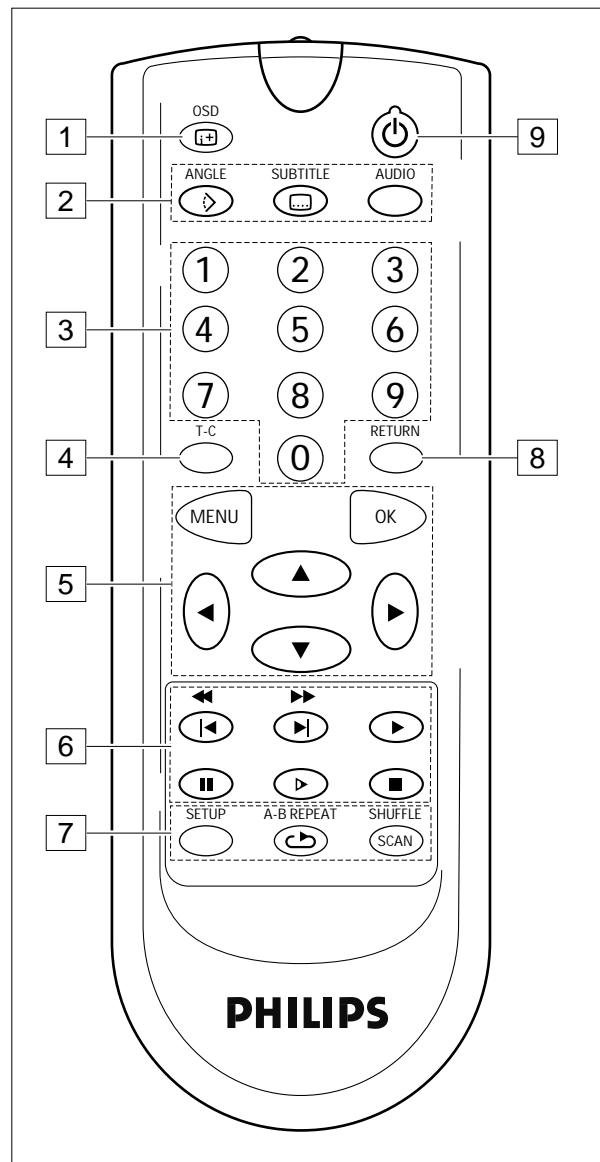

\* Press key for about 1 second

# STANDARD CONNECTIONS

## GENERAL NOTE

- Depending on your TV and other equipment, there are various ways you could connect the DVD-Video player. These are shown below.
- Please refer to your TV, VCR, Stereo System and any other User Manual(s) as necessary to make the optimal connections.

## HIGHEST QUALITY A/V CONNECTION

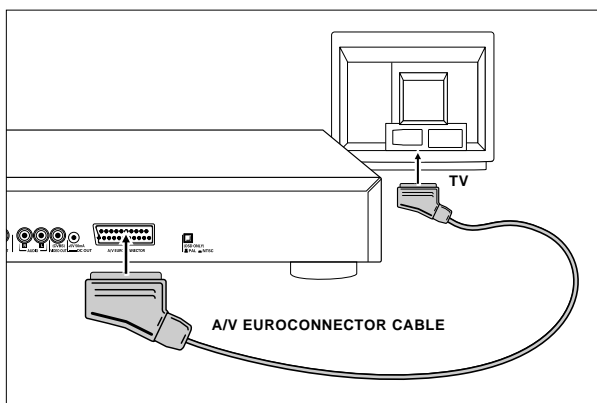

Connection to a TV with an A/V Euroconnector socket.

- 1 Connect the A/V Euroconnector on the rear of the player to the corresponding connector on the TV using the cable supplied.
- 2 Optionally you can also connect the audio Left and Right channel sockets on the rear of the player to the corresponding sockets on your stereo system.

### NOTE

- Do not connect your DVD-player via your VCR, because the video quality could be distorted by the copy protected system.

## EXCELLENT A/V CONNECTION

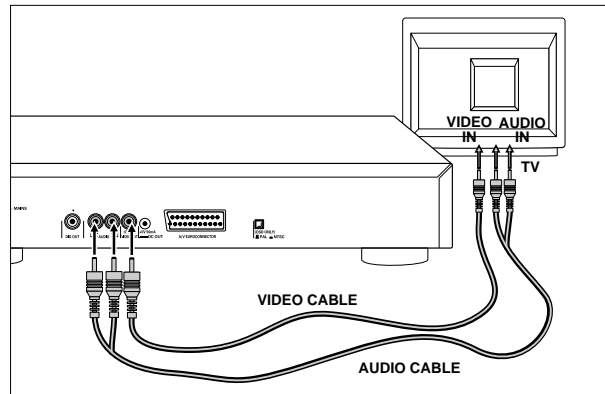

Connection to a TV with a video (CVBS) socket.

- 1 Connect the Video socket on the rear of the player to the corresponding socket on the TV using the cable supplied.
- 2 Connect the audio Left and Right channel sockets on the rear of the player to the corresponding sockets on the TV using the cable supplied. Alternatively, you can use the same cable to connect the audio Left and Right sockets on the rear of the player to the corresponding sockets on your stereo system.

### CAUTION

**Do not connect the player's audio output to the phono input of your stereo system.**

# STANDARD CONNECTIONS

## MULTICHANNEL SOUND FOR HOME THEATRE

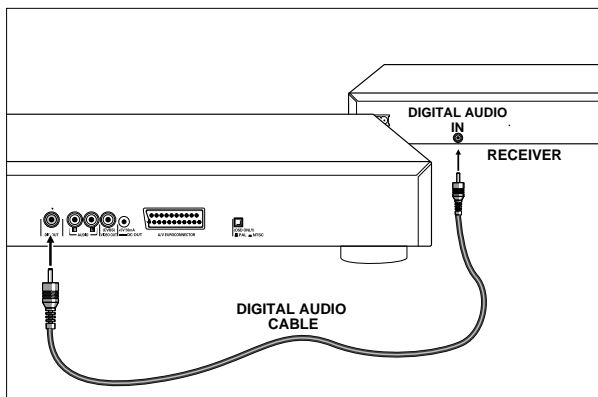

For multichannel sound, your player provides both digital and analog audio outputs.

### DIGITAL (MPEG 2 MULTICHANNEL OR DOLBY DIGITAL™) MULTICHANNEL SOUND

- 1 For this, which provides the highest multichannel sound quality, you need a digital multichannel A/V receiver.
- 2 Connect the digital audio output on the rear of the player to a suitable input on the receiver using a digital audio cable (available as option). In this case, do not use the player's audio Left and Right outputs.
- 3 You will need to activate the digital output of the player (See Settings p. 20).
- 4 The audio format of the digital output is dependent on the audio format of the selected audio stream. Make sure that the selected audio stream matches the capabilities of the receiver connected to the digital output.

### ANALOG (DOLBY PRO LOGIC™) MULTICHANNEL SOUND

- 1 If your TV set has a Dolby Pro Logic™ decoder, simply hook up the player to the TV using the A/V Euroconnector, or Video (CVBS) and audio connections as on p. 9.
- 2 If not, make the A/V Euroconnector, or Video (CVBS) connection to the TV p. 9, and connect the player's audio Left and Right outputs to suitable inputs on a Dolby Pro Logic™ Audio/Video receiver, using the cable supplied.
- 3 For speaker connections, follow the instructions given in the TV set or A/V receiver user manual.

#### NOTE

- You cannot use the RF Modulator option for home theatre.
- If the audio format of the digital output does not match the capabilities of your receiver, the sound will be muted.

## DIGITAL AUDIO (STEREO) SOUND CONNECTION

For this connection, which produces the highest possible stereo sound quality, you need an audio amplifier with digital input, and the digital output of the player must be activated (see Settings p. 20). Connect the player's digital audio output to the corresponding input on the amplifier. In this case, do not use the player's audio Left and Right outputs.

## NTSC/PAL SETTING

Use the NTSC/PAL switch on the rear of the player to set the Video CD and player menu according to the standard used by your TV-set.

#### NOTE

- The video output standard for video CD and DVD-Video discs most corresponds to the disc being played.

## CONNECTING THE POWER SUPPLY

- 1 Plug the female end of the power cord supplied into the Power connector on the rear of the player.
- 2 Plug the male end of the cord into an AC outlet.

#### NOTE

- The player automatically adjust to the local AC voltage.
- When the player is in the "OFF" position, it still consumes some power. If you wish to disconnect your player completely from the power supply, withdraw the plug from the AC Outlet.

### CAUTION

**Only qualified service personnel should remove the cover or attempt to service this device.**

## INFRARED REMOTE CONTROL

## LOADING THE BATTERIES

- 1 Open the battery compartment cover.
- 2 Insert two 'AAA' (R03) batteries as indicated inside the battery compartment.
- 3 Close the cover.

**CAUTION**

*Do not mix old and new batteries. and NEVER mix different types of batteries (standard, alkaline and so on).*

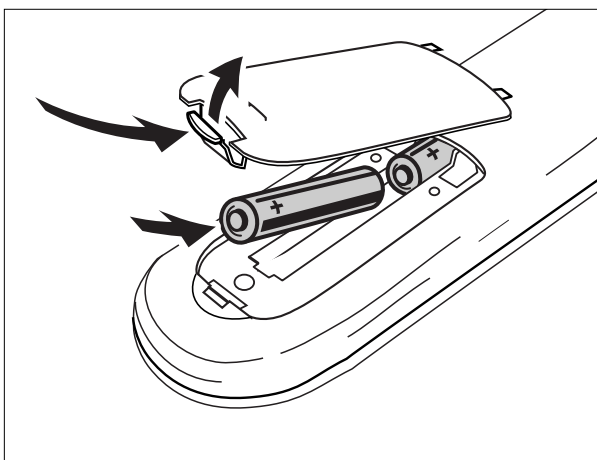

## OPERATION

## NOTE

- Unless otherwise mentioned, all operations can be carried out with the remote control. Always point the remote control directly at the player, making sure there are no obstructions in the path of the infrared beam.
- When there are corresponding keys on the front panel, they can also be used.

## SWITCHING ON

- 1 Switch on the TV and select the video input for your DVD-Video player.
- 2 To enjoy sound through your stereo system, turn on the system and select the source input for the DVD-Video player.  
or  
To enjoy DVD-Video with multichannel (surround) sound, switch on the Home Theatre system and select the source input for your DVD-Video player.
- 3 On the front of the DVD-Video player, press ON/OFF. The player display lights, and the OSD invites you to insert a disc.
- 4 With Autoplay on (the factory setting) any disc already inserted in the player starts to play.

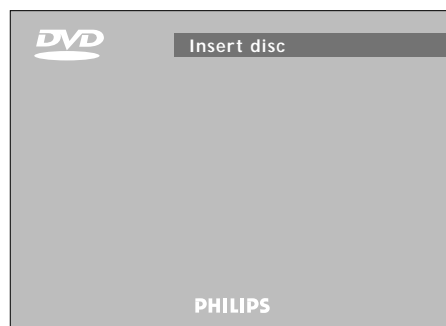

## INSERTING A DISC

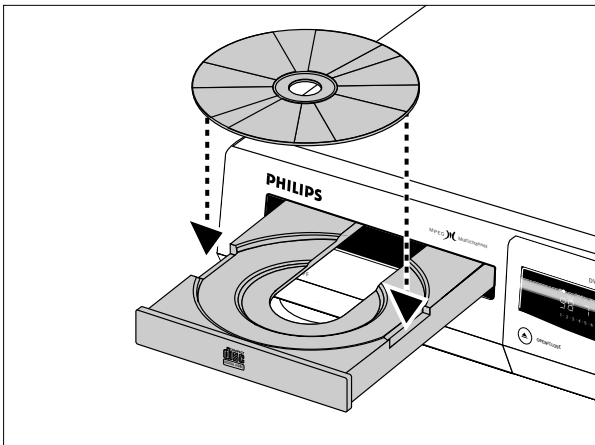

- 1 Press OPEN/CLOSE on the front of the player. The disc tray opens.
- 2 Lay your chosen disc in the tray, label side up. Make sure it is sitting properly in the correct recess.
- 3 Gently push the tray, or press OPEN/CLOSE, to close the tray.
  - With Autoplay on (the factory setting) play starts.
  - With Autoplay off, the (play) screen for the type of disc inserted appears on the OSD, and information about the disc's contents and total playing time appear on the display.
  - To turn Autoplay off or on, see Settings (p. 20).

### NOTE

- Since it is usual for DVD movies to be released at different times in different regions of the world, all players have region codes, and discs can have an optional region code. If you insert a disc of a different region code to your player, you will see the region code notice on the screen. The disc will not play, and should be removed.

## PLAYING A DVD-VIDEO DISC

You will recognize DVD-Video discs by the logo. Depending on the material on the disc (a movie, video clips, a drama series, etc.) it may have one or more Titles, and each Title may have one or more Chapters. Play stops at the end of each Title. To make access easy and convenient, your player lets you move between Titles, and also between Chapters.

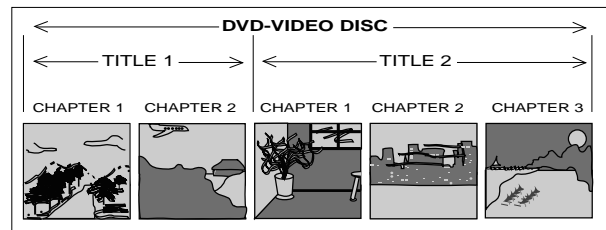

### NOTE







- During play, various icons will appear on the TV screen for about 2 seconds to confirm that a function has been selected. You can get rid of these icons by pressing OSD.
- At any time during play, you can press OSD to call up the Play Banner, which shows you which functions are active, for about 2 seconds. To keep the Play Banner on the screen, hold down OSD for a couple of seconds. To get rid of the Play Banner, press OSD again.

### List of icons:

	.....Play
	.....Pause
	.....Stop
	.....A-B repeat
	.....Search forward
	.....Search backward
	.....Slow forward
	.....Repeat disc
	.....Repeat title
	.....Repeat chapter
	.....Chapter shuffle
	.....Title indication
	.....Chapter indication
	.....Disable function
	.....Angle
	.....No alternative angle
	.....Subtitle language



# PLAYING A DVD-VIDEO DISC



	.....Audio language
	.....Audio system
	.....Remaining time of title
	.....Elapsed time
	.....Resume
	.....Total time

## PLAYING A TITLE

- With Autoplay on, play starts when you close the disc drawer.
- With Autoplay off, press ►.

### NOTE

- Some DVD-Video discs carry their own Autoplay, in which case play always starts automatically.

- The disc may invite you to select an item from a menu. If the selections are numbered, press the appropriate numerical key; if not, use  to highlight your selection, and press OK.  
→ As the disc plays, the player display shows the current title and chapter, and the elapsed playing time.
- Play will stop at the end of a Title and this can result in return to menu. To go on to the next Title, press ►.
- To stop play at any other time, press ■.
- You can resume play from the point at which you stopped. Press ► twice.
- The RESUME feature applies, not only to the disc in the player, but also to the last four discs you have played. Simply re-insert the disc, press ► if Autoplay is off, and when you see the Resume icon on the screen,  press ► again.

## MOVING TO ANOTHER CHAPTER

When a title on a disc has more than one chapter (which you can see from the player display), you can move to another chapter as follows:

- Press ► briefly during play to step forward to the next chapter.
- Press ◀ briefly during play to return to the beginning of the current chapter. Press ◀ briefly again to step back to the beginning of the previous chapter.
- To go directly to any chapter, enter the chapter number using the numerical keys.

### NOTE

- If the number has more than one digit, press the keys in rapid succession.

- For more information about chapters, see "Checking the contents of DVD-Video discs: Menus" p. 15.

## MOVING TO ANOTHER TITLE

When a disc has more than one title (which you can see from both the OSD and the player display if you press ■), you can move to another title as follows:

- Press T-C, then press ► briefly during play to step forward to the next title.
- Press T-C, then press ◀ briefly during play to return to the beginning of the current title. Press ◀ briefly again to step back to the beginning of the previous title.
- To go directly to any title, press T-C, then enter the title number using the numerical keys.

### NOTE

- If the number has more than one digit, press the keys in rapid succession.

- For more information about titles, see "Checking the contents of DVD-Video discs: Menus" p. 15.

## PARENTAL CONTROL



- If you activate Parental Control, only discs that you have already authorised as suitable for all ages can be played as above.
- To play any other DVD-Video disc, the OSD will ask you to enter your Parental Control PIN code. When this has been done, play starts automatically.
- To activate Parental Control, and to authorize discs, see Activating Parental Control (p. 22).

# PLAYING A DVD-VIDEO DISC

## NOTE

- If you forget your PIN code, you can erase it when the code is requested as above, by pressing **■** four times. Parental Control will then be de-activated. To re-activate it, see *Activating Parental Control* (p. 22).

## STILL PICTURE AND STEP FRAME

- To get a still picture, press **⏸** during play.
- To step forward to the next picture frame, press **⏸** again.
- To return to play, press **▶**.

## SEARCH

- To search forwards or backwards through the disc at 4x normal speed, press **▶** or **◀** for about 1 second during play.  
→ Search begins, and sound is muted.
- To step up to 32x normal speed, press **▶** or **◀** again.
- To go directly to 32x normal speed, hold down **▶** or **◀** until the **▶▶▶** or **◀◀◀** icon appears.
- To return to 4x normal speed, press **▶** or **◀** again.  
→ Search speed and direction are indicated on the screen for 2 seconds each time **▶** or **◀** is pressed.
- To end the search, press **▶**, **⏸**, **▶**, or **■** as desired.

## SLOW MOTION

- Press **▶** to play video at 1/2 normal speed with sound muted.
- Press **▶** again to play at 1/4 normal speed.
- Press **▶** again to play at 1/8 normal speed.
- Press **▶** again to play video at 1/2 normal speed
- Play speed is indicated on the screen for 2 seconds each time the button is pressed.
- To exit slow motion mode, press **▶**, **⏸**, **◀▶** or **■** as desired.

## SHUFFLE

This shuffles the playing order of chapters within a title, if the title has more than one.

- Press SHUFFLE briefly during play.  
→  appears on the screen for about 2 seconds.
- As each chapter is played, its number disappears from the track calendar.

- To return to normal play, press SHUFFLE briefly.

## REPEAT CHAPTER/TITLE/DISC



- To repeat the currently playing chapter, press REPEAT for about 1 second:  
→ **REPEAT CHAPTER** appears on the player display.
- To repeat the currently playing title, press REPEAT a second time for about 1 second:  
→ **REPEAT TITLE** appears on the display.
- To repeat the entire disc, press REPEAT a third time for about 1 second;  
→ **REPEAT** appears on the display.
- To exit Repeat mode, press REPEAT a fourth time for about 1 second.

## A-B REPEAT

To repeat or loop a sequence in a title:



- Press A-B REPEAT briefly at your chosen starting point;  
→ **A** appears on the player display.
- Press A-B REPEAT briefly again at your chosen end point;  
→ **A-B** appears on the display, and the repeat sequence begins.
- To exit the sequence, press A-B REPEAT briefly again.

## CAMERA ANGLE

- If the disc contains sequences recorded from different camera angles, the angle icon appears  showing the number of available angles, and the angle being shown. You can then change the camera angle if you wish.
- To get another angle, press ANGLE .  
→ The angle icon will show the next angle.
- To go to any angle directly, enter the angle number using the numerical keys (0-9).

## NOTE

- The angle icon remains on the screen unless you turn off the angle feature.

- To turn off the angle feature, press OSD :  
→ the angle icon disappears.
- To turn the angle feature on again, press angle  again:  
→ the angle icon reappears.

## CHANGING THE AUDIO LANGUAGE AND CHANNEL CONFIGURATION

---

This changes the language and the audio channel configuration when alternatives are available on the disc.



- Press AUDIO during play.
  - The audio language and channel configuration icons appear on the screen for 2 seconds.
- Press AUDIO repeatedly to step through the options.
  - At each step, the language changes. If the sound configuration changes too (for example from multichannel to stereo) this is also indicated.



- Press T-C followed by MENU.
  - If the disc has a title menu, this now appears on the OSD.
- To remove the title menu, press T-C again.

## SUBTITLES

---

- When subtitles are available on a disc, you can turn them on by holding SUBTITLE  down during play until the subtitles appear.
- To step through the language options, press SUBTITLE  repeatedly.
- To turn the subtitles off, hold SUBTITLE  down again.

## SCAN

---

Plays the first 10 seconds of each title on the disc.

- Press SCAN for about 1 second.
- To continue play at your chosen title, press SCAN again for about 1 second or press ►.

## CHECKING THE CONTENTS OF DVD-VIDEO DISCS: MENUS

---

For titles and chapters, selection menus may be included on the disc. The DVD's player's menu feature allows you to make selections from these menus. Press the appropriate numerical key; or use the  keys to highlight your selection, and press OK.

- Press MENU.
  - If the present title has a "root" menu, this now appears on the OSD.
- The "root" menu can list camera angles, spoken language and subtitle language options, and chapters for the title.
- To exit the "root" menu, press MENU again.

# PLAYING A VIDEO CD

## PLAYING A VIDEO CD

You will recognize Video CDs by the logo. Depending on the material on the disc (a movie, video clips, a drama series, etc.) it may have one or more tracks, and tracks may have one or more indexes, as indicated on the disc case. To make access easy and convenient, your player lets you move between tracks, and between indexes.



Some Video CDs have Playback Control (PBC), which is a pre-defined playback sequence stored on the disc.

### NOTE

- During play, various icons will appear on the TV screen for about 2 seconds to confirm that a function has been selected. You can get rid of these icons by pressing OSD.

- At any time during play, you can press OSD to call up the Play Banner, which shows you which functions are active, for about 2 seconds. To keep the Play Banner on the screen, hold down OSD for a couple of seconds. To get rid of the Play Banner, press OSD again.

- List of icons:

	.....Play
	.....Pause
	.....Stop
	.....A-B repeat
	.....Search forward
	.....Search backward
	.....Slow forward
	.....Repeat disc
	.....Repeat track
	.....Shuffle
	.....Track indication
	.....Index indication
	.....Remaining time of title
	.....Elapsed time
	.....Total time

## PLAYING A DISC

- With Autoplay on, play starts when you close the disc drawer.
- With Autoplay off, press ►.
- As the disc plays, the display shows the current track, and the elapsed playing time.
- Play will stop at the end of the disc.
- To stop play at any other time, press ■.
- You can resume play from the point at which you stopped. Press ► twice.
- The RESUME feature applies, not only to the disc in the player, but also to the last four discs you have played. Simply re-insert the disc, press ► if Autoplay is off, and when you see the Resume icon on the screen , press ► again.

## MOVING TO ANOTHER TRACK

When a disc has more than one track (which you can see from both the OSD and the player display if you press ■), you can move to another track as follows:

- Press T-C, then press ► briefly during play to step forward to the next track.
- Press T-C, then press ◀ briefly during play to return to the beginning of the current track. Press ◀ briefly again to step back to the beginning of the previous track.
- To go directly to any track, press T-C, then enter the track number using the numerical keys.

### NOTE

- If the number has more than one digit, press the keys in rapid succession.

## MOVING TO ANOTHER INDEX

When a track has more than one index (as indicated on the disc case), you can move to another index as follows:

- Press ► briefly during play to step forward to the next index.
- Press ◀ briefly during play to return to the beginning of the current index. Press ◀ briefly again to step back to the beginning of the previous index.
- To go directly to any index enter the index number using the numerical keys.

## NOTE

- If the number has more than one digit, press the keys in rapid succession.

## PLAYBACK CONTROL (PBC)

- Insert a Video CD with PBC and press ►.  
→ The PBC menu appears on the TV screen.
- Go through the menu with the keys indicated on the TV screen until your chosen passage starts to play. If a PBC menu consists of a list of titles, you can select a title directly.
- Enter your choice with the ◀, ▶ or numerical keys.
- Press ► to start play of the selected title.
- Press RETURN to go back to the previous menu.

## PARENTAL CONTROL



- If you activate Parental Control, only discs that you have already authorised as suitable for all ages can be played as above.
- To play any other Video CD, the OSD will ask you to enter your Parental Control PIN Code. When this has been done, play starts automatically.
- To activate Parental Control, and to authorize discs, see Activating Parental Control (p. 22).

## NOTE

- If you forget your PIN code, you can erase it when the code is requested as above, by pressing ■ four times. Parental Control will then be de-activated. To re-activate it, see Activating Parental Control (p. 22).

## STILL PICTURE AND STEP FRAME

- To get a still picture, press ■ during play.
- To step forward to the next picture frame, press ■ again.
- To return to play, press ►.

## SEARCH

- To search forwards or backwards through the disc at 4x normal speed, press ► or ◀ for about 1 second during play.  
→ Search begins, and sound is muted.
- To step up to 32x normal speed, press down ► or ◀ again.
- To go directly to 32x normal speed, hold down ► or ◀ until the ►► or ◀◀ icon appears.
- To return to 4x normal speed, press down ► or ◀ again.  
→ Search speed and direction are indicated on the screen for 2 seconds each time ► or ◀ is pressed.
- To end the search, press ►, ■, ► or ■ as desired.

## SLOW MOTION

- Press ► to play video at 1/2 normal speed with sound muted.
- Press ► again to play at 1/4 normal speed.
- Press ► again to play at 1/8 normal speed.
- Press ► again to play video at 1/2 normal speed.
- Play speed is indicated on the screen for 2 seconds each time the button is pressed.
- To exit slow motion mode, press ►, ■, ◀/► or ■ as desired.

## SHUFFLE

This shuffles the playing order of the tracks, if the disc has more than one.

- Press SHUFFLE briefly during play.  
→  appears on the screen for about 2 seconds.
- As each track is played, its number disappears from the track calendar.
- To return to normal play, press SHUFFLE briefly.

## REPEAT TRACK/DISC

- To repeat the currently playing track, press REPEAT for about 1 second:  
→ REPEAT TRACK appears on the player display.
- To repeat the entire disc, press REPEAT a second time for about 1 second;  
→ REPEAT appears on the display.

- To exit Repeat mode, press REPEAT a third time for about 1 second.

### A-B REPEAT

To repeat or loop a sequence:

- Press A-B REPEAT briefly at your chosen starting point; → **A** appears on the player display.
- Press A-B REPEAT briefly again at your chosen end point; → **A-B** appears on the display, and the repeat sequence begins.
- To exit the sequence, press A-B REPEAT briefly again.

### SCAN

Plays the first 10 seconds of each title on the disc.

- Press SCAN for about 1 second.
- To continue play at your chosen title, press SCAN again for about 1 second or press ►.

## PLAYING AN AUDIO CD

Audio CDs contain music tracks only. You will recognize CDs by their logo.

You can play audio CDs using the OSD or, through a stereo system only, using keys on the remote control and/or front panel.



### PLAYING A DISC

- With Autoplay on, play starts when you close the disc drawer.
- With Autoplay off, press ►. → The disc starts to play; if the TV is on, the CD Play screen appears on the OSD.

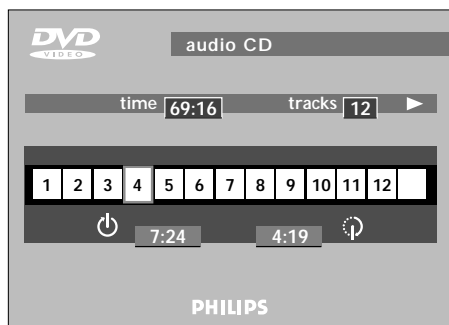

→ Play will stop at the end of the disc.

- To stop play at any other time, press ■.

### PAUSE

- Press **||** during play.
- To return to play, press ►.

### SEARCH

- To search forwards or backwards through the disc at 4x normal speed, press ► or ◀ for about 1 second during play. → Search begins, and sound is partially muted.
- To step up to 8x normal speed, press ► or ◀ again. → Search goes to 8x speed, and the sound is muted.
- To go directly to 8x normal speed, hold down ► or ◀ until the ►8 or ◀8 icon appears.
- To return to 4x normal speed, press ► or ◀ again.
- If the TV is on, search speed and direction are indicated on the screen each time ► or ◀ is pressed.
- To end the search, press ►, || or ■ as desired.

### MOVING TO ANOTHER TRACK

- Press ► briefly during play to step forward to the next track.
- Press ◀ briefly during play to return to the beginning of the current track. Press ◀ briefly again to step back to the beginning of the previous track.
- To go directly to any track, enter the track number using the numerical keys.

### NOTE

- If the number has more than one digit, press the keys in rapid succession.

### SHUFFLE

- Press SHUFFLE briefly during play. → The order of the tracks is changed.
- As each track is played, its number disappears from the player display.
- To return to normal play, press SHUFFLE briefly again.

### REPEAT TRACK/DISC

- To repeat the current-playing track, press REPEAT for about 1 second: → **REPEAT TRACK** appears on the display.

- To repeat the entire disc, press REPEAT a second time for about 1 second;  
→ REPEAT appears on the display.
- To exit Repeat mode, press REPEAT a third time for about 1 second.

## A-B REPEAT

To repeat or loop a sequence:

- Press A-B REPEAT briefly at your chosen starting point;  
→ A appears on the player display.
- Press A-B REPEAT briefly again at your chosen end point;  
→ A-B appears on the display, and the repeat sequence begins.
- To exit the sequence, press A-B REPEAT briefly again.

## SCAN

Plays the first 10 seconds of each title on the disc.

- Press SCAN for about 1 second.
- To continue play at your chosen title, press SCAN again for about 1 second or press ►.

## FTS (FAVOURITE TRACK SELECTION)

### NOTE

- FTS Favourite Track Selections are compiled and played using the OSD: ensure that the TV is on.

### Playing an FTS program

If Auto FTS is set to on, play of the FTS program starts immediately. If Auto FTS is off:

- 1 Insert a disc and go to Stop mode.
- 2 Press **◀** or **▶** to start compiling FTS programs.
- 3 If available the existing FTS program appears
- 4 Follow instructions under "To exclude tracks" or "To select tracks".

To turn Auto FTS on and off, see Settings, p. 20

### Compiling an FTS program

FTS programs can be compiled by selecting the tracks you want to play ("Track Selection") or by excluding the tracks you don't want to play ("Excluding Tracks")

### To exclude Tracks:

- 1 Insert a disc and go to Stop mode.
- 2 Press **◀**
- 3 Use **◀** or **▶** to move to the first track number you want to exclude.
- 4 Press **■**.
- 5 Repeat steps 3 and 4 to exclude further track numbers in the same way. If you change your mind, you can re-include any track number by moving back to it and pressing **▶**.
- 6 To clear your whole selection and start again, press **■**.

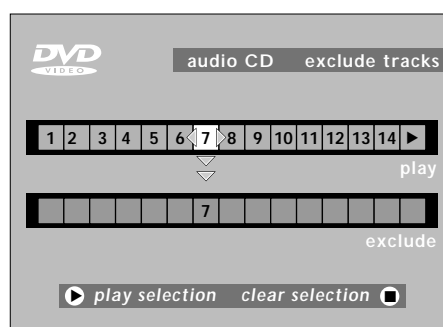

**To select Tracks:**

- 1 Insert a disc and go to Stop mode.
- 2 Press **.**
- 3 Use **←** or **→** to move to the first track number you want to select.
- 4 Press **.**
- 5 Repeat steps 3 and 4 to select further track numbers in the same way. If you change your mind, you can de-select track numbers in reverse order by pressing **←** as required.
- 6 To clear your whole selection and start again, press **■**.

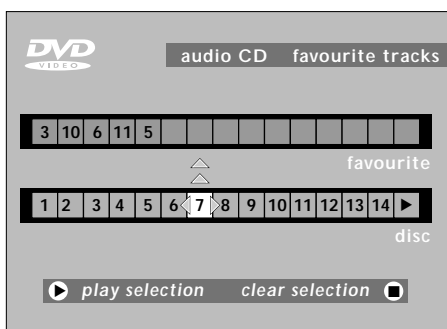

When your FTS program is complete, press **▶** to start play, or **RETURN** to go back to Stop mode. In either case, the FTS program will be automatically memorized.

**NOTE**

- You can have a total of at least 100 FTS programmed discs. If you exceed that number, the least frequently played FTS program(s) are automatically deleted.

**SETTINGS**

In the settings menu, you can customize your player to suit your own particular requirements.

In Stop mode:

- Press **SETUP** to obtain the Settings screen.

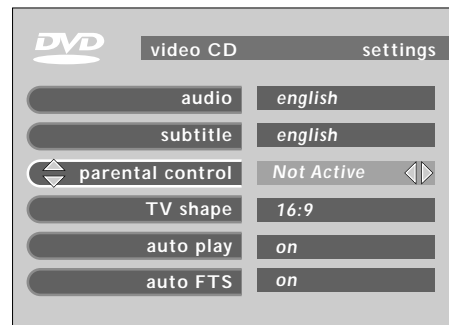

- Move to the function you want to change using **←** or **→** then use **↑** or **↓** to scroll to your preferred option.

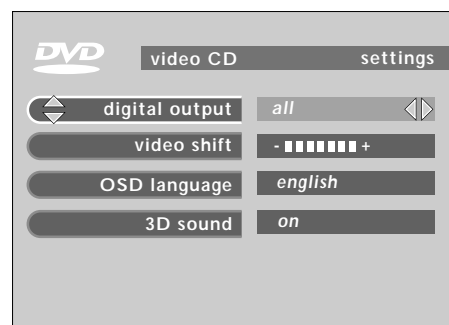

- To exit Settings menu, press **RETURN** or **SETUP**.

**Audio**

The sound will be in the language you choose provided this is available on the disc in play. If not, speech will revert to the first spoken language on the disc.

**Subtitle**

The subtitles will be in the language you choose provided this is available on the disc in play. If not, subtitles will revert to the first subtitle language on the disc.

**Parental Control**

Parental Control is described separately under 'Parental Control' p. 22.



## TV Shape

Factory setting 16:9 (wide screen). If you have a regular (4:3) TV, you can choose Letterbox for a 'wide-screen' picture with black bars top and bottom, or Pan Scan, for a full-height picture with the sides trimmed. If a disc has Pan Scan, the picture then moves (scans) horizontally to keep the main action on the screen.

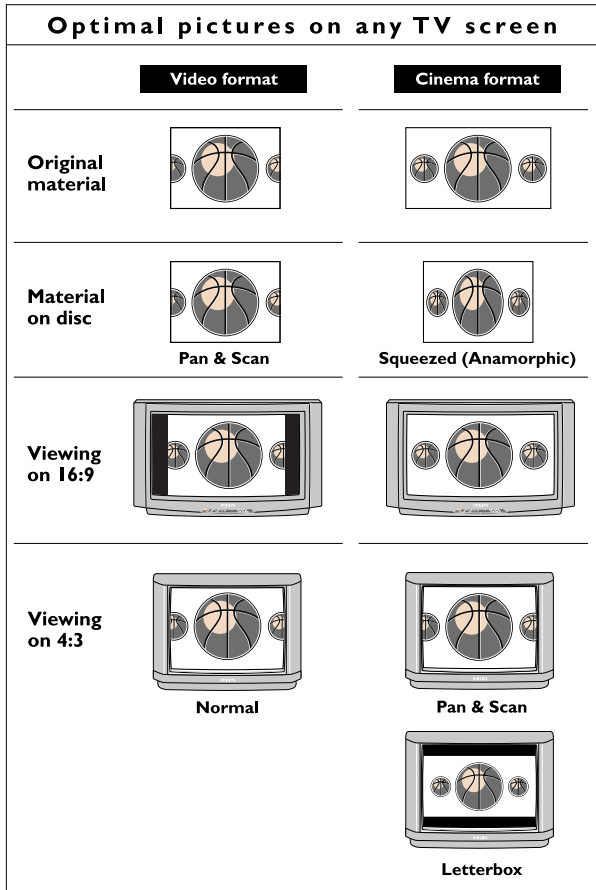

## Auto Play

Factory setting ON means that discs starts to play automatically when inserted. Set to OFF if you prefer to start play manually.

## Auto FTS

Factory setting ON means that when a disc with an FTS program (see 'Compiling an FTS program p. 19) is inserted, the FTS program automatically starts to play. Set to Off if you prefer to control FTS play manually.

## Digital Output

Factory setting OFF means that there is no audio signal at the digital output. If you are connecting equipment with a digital input, change the setting to ALL.

If your equipment doesn't include a digital decoder, (e.g. digital speakers) set the digital output to PCM.

## Video Shift

Factory setting centers the video on your TV screen. Use this setting to personalize the position of the picture on your TV by scrolling it to the left or right.

## OSD Language

The player's on-screen display will be in the language you choose.

## 3D Sound

To enjoy multichannel sound even on two speakers, turn 3D Sound on.



# PARENTAL CONTROL

## PARENTAL CONTROL

### ACTIVATING PARENTAL CONTROL

This can only be done in Stop mode

- 1 Press **SETUP** to obtain the Settings menu.
- 2 Move to Parental Control using **←**.
- 3 Press **OK** or **ENTER** to change Parental Control to Active.
- 4 You will be asked to enter a 4-digit pin code of your own choice, and then to confirm your choice.
- 5 This code must then be entered to play any DVD-Video or Video CD disc, unless you have previously authorized the disc as suitable for all ages.
- 6 To de-activate Parental Control repeat the above procedure.

### AUTHORIZING DISCS

- 1 Insert the disc you wish to authorize and close the tray.  
→ The OSD will ask for your pin code.
- 2 Enter your pin code.
- 3 Press **OK**.
- 4 Select Parental Control on the OSD by pressing **←**.  
→ The OSD will ask for your pin code.
- 5 The disc is now authorized, and will play in the normal way, without the pin code.

To cancel your authorization, repeat steps 4 and 5.

#### NOTE

- You can have a total of 50 authorized discs. If you exceed that number, the least frequently played disc(s) are automatically de-authorized.

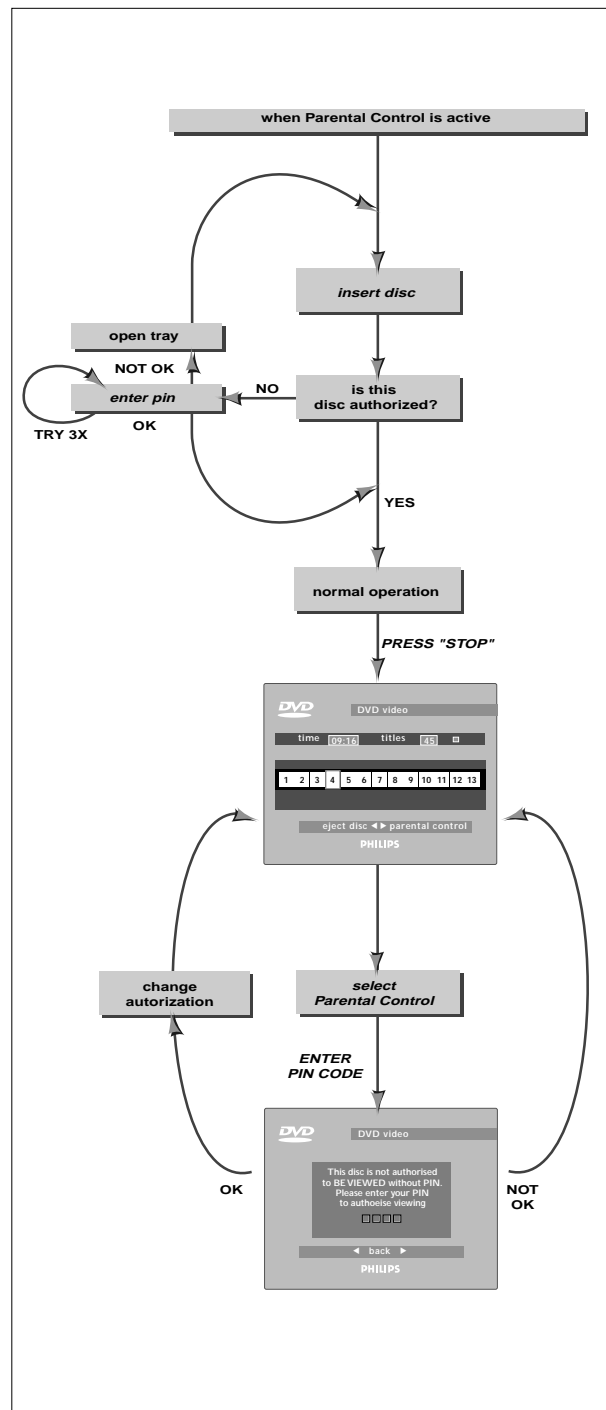

# BEFORE REQUESTING SERVICE

## BEFORE REQUESTING SERVICE

If it appears that the DVD-Video player is faulty, first consult this checklist. It may be that something simple has been overlooked. Under no circumstances attempt to repair the system yourself; this will invalidate the warranty.

Look for the specific symptom(s). Then perform only the actions listed to remedy the specific symptom(s).

### SYMPTOM

- Remedy

### NO POWER

- Check if the on/off button on the front of the player is set to on.
- Check if both plugs of the mains cord are properly connected.
- Check if there is power at the AC outlet by plugging in another appliance.

### NO PICTURE

- Check if the TV is switched on.
- Select the same channel and source on the TV as on the player.
- Check the video connection.

### DISTORTED PICTURE

- Check the disc for fingerprints and clean with a soft cloth, wiping from centre to edge.
- Sometimes a small amount of picture distortion may appear. This is not a malfunction.

### COMPLETELY DISTORTED PICTURE WITH PLAYER MENU

- NTSC/PAL switch in wrong position.

### NO COLOUR IN PICTURE WITH PLAYER MENU

- NTSC/PAL switch in wrong position.

### DISC CAN'T BE PLAYED

- Ensure the disc label is upwards.
- Clean the disc.
- Check if the disc is defective by trying another disc.

### NO SOUND

- Check audio connections.
- If using a HiFi amplifier, try another sound source.

### DISTORTED SOUND FROM HIFI AMPLIFIER

- Check that the player's audio L/R output is not connected to the amplifier's phono input.

### NO RETURN TO START-UP SCREEN WHEN DISC IS REMOVED

- Reset by switching the player off, then on again.
- Check to see if the program requires another disc to be loaded.

### THE PLAYER DOES NOT RESPOND TO THE REMOTE CONTROL

- Aim the remote control directly at the sensor on the front of the player.
- Avoid all obstacles which may interfere with the signal path.
- Inspect or replace the batteries.

### DISTORTED OR BLACK AND WHITE PICTURE WITH DVD OR VIDEO CD DISC

- The disc format is not according to the TV-set used (NTSC/PAL).

### NO AUDIO AT DIGITAL OUTPUT

- Check the digital connections.
- Check the settings menu to make sure that the digital output is set to on.
- Check if the audio format of the selected audio language matches your receiver capabilities.

### BUTTONS DO NOT WORK

- Reset by switching the player off, then on again.

## CLEANING DISCS

Some problems occur because the disc inside the player is dirty. To avoid such problems clean your discs regularly with a soft cloth. Wipe the disc from the center out.

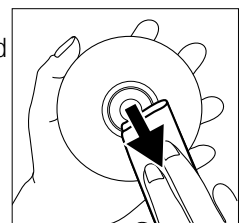

### CAUTION

*Do not use solvents such as benzene, thinner, commercially available cleaners, or anti-static spray intended for analog discs.*



# BEFORE REQUESTING SERVICE

## DIAGNOSTIC PROGRAM

If the fault persists, you can run the Diagnostic Program in the player.

### INSTRUCTIONS:

---

- 1 Switch the player off.
- 2 Hold both OPEN/CLOSE and **II** pressed and switch on the player.
  - 'BUSY' appears on the display together with a counter. The counter indicates the termination of the test when it reaches zero.
  - After a few minutes, 'BUSY' changes to 'ERROR' or 'PASS'.
- 3 Switch off the player to exit the Diagnostic Program.
- 4 'ERROR' indicates that your player needs repair. Contact your dealer or the Philips Consumer Information Center (CIC).
- 5 'PASS' indicates that the Diagnostic Program has found no fault. In this case, the malfunction may be due to misinterpretation of the operating instructions, or an unsuitable disc, or incorrect connections. If you still cannot solve the problem, contact your dealer or the Philips CIC.
- 6 You will find the phone number of the Philips CIC in your Warranty Booklet.