



Important!
Return your
Warranty
Registration Card
within 10 days.
See why inside.



Read this manual first!

*Congratulations on purchasing this product.
We've included everything you need to get started.
If you have any problems, our Representatives can
help you get the most from your new product by explaining:*

- Hookups,
- First Time Setup, and
- Feature Operation.

Do not attempt to return this product to the store.

**For fast help, call us first!
1-800-531-0039**

Thank you for making us a part of your home!

Let's make things better.



PHILIPS

Return your Warranty Registration card today to ensure you receive all the benefits you're entitled to.

Once your PHILIPS purchase is registered, you're eligible to receive all the privileges of owning a PHILIPS product. So complete and return the Warranty Registration Card enclosed with your purchase at once. And take advantage of these important benefits.

Warranty Verification

Registering your product within 10 days confirms your right to maximum protection under the terms and conditions of your PHILIPS warranty.

Owner Confirmation

Your completed Warranty Registration Card serves as verification of ownership in the event of product theft or loss.

Model Registration

Returning your Warranty Registration Card right away guarantees you'll receive all the information and special offers which you qualify for as the owner of your model.

PHILIPS

Congratulations on your purchase, and welcome to the "family!"

Dear PHILIPS product owner:

Thank you for your confidence in PHILIPS. You've selected one of the best-built, best-backed products available today. And we'll do everything in our power to keep you happy with your purchase for many years to come.

As a member of the PHILIPS "family," you're entitled to protection by one of the most comprehensive warranties and outstanding service networks in the industry.

What's more, your purchase guarantees you'll receive all the information and special offers for which you qualify, plus easy access to accessories from our convenient home shopping network.

And most importantly you can count on our uncompromising commitment to your total satisfaction.

All of this is our way of saying welcome-and thanks for investing in a PHILIPS product.

Sincerely,



Lawrence J. Blanford
President and Chief Executive Officer

P.S. Remember, to get the most from your PHILIPS product, you must return your Warranty Registration Card within 10 days. So please mail it to us right now!



Know these safety symbols



⚡ This "bolt of lightning" indicates uninsulated material within your unit may cause an electrical shock. For the safety of everyone in your household, please do not remove product covering.

⚠ The "exclamation point" calls attention to features for which you should read the enclosed literature closely to prevent operating and maintenance problems.

WARNING: TO PREVENT FIRE OR SHOCK HAZARD, DO NOT EXPOSE THIS EQUIPMENT TO RAIN OR MOISTURE.

CAUTION: To prevent electric shock, match wide blade of plug to wide slot, fully insert.

ATTENTION: Pour éviter les choc électriques, introduire la lame la plus large de la fiche dans la borne correspondante de la prise et pousser jusqu'au fond.

For Customer Use

Enter below the Serial No. which is located on the rear of the cabinet. Retain this information for future reference.

Model No. _____
Serial No. _____



PHILIPS

Visit our World Wide Web Site at <http://www.philips.com>

Safety Precautions

Warning: To prevent fire or shock hazard, do not expose this equipment to rain or moisture.

Federal Communications Commission (FCC) Warning: Any unauthorized changes or modifications to this equipment void the user's authority to operate it.

Laser Safety

This unit employs a laser. Only a qualified service person should remove the cover or attempt to service this device, due to possible eye injury.

CAUTION: USE OF CONTROLS OR ADJUSTMENTS OR PERFORMANCE OF PROCEDURES OTHER THAN THOSE SPECIFIED HEREIN MAY RESULT IN HAZARDOUS RADIATION EXPOSURE.

CAUTION: VISIBLE AND INVISIBLE LASER RADIATION WHEN OPEN AND INTERLOCK DEFEATED. DO NOT STARE INTO BEAM. THE BEAM IS LOCATED INSIDE, NEAR THE DECK MECHANISM.

Special Information for Canadian Users

This Class B digital apparatus complies with Canadian ICES-003.

Cet appareil numérique de la classe B est conforme à la norme NMB-003 du Canada.

Radio/TV Interference

This equipment has been tested and found to comply with the limits for a Class B digital device, pursuant to Part 15 of the FCC Rules. These limits are designed to provide reasonable protection against harmful interference in a residential installation. This equipment generates, uses, and can radiate radio frequency energy and, if not installed and used in accordance with the instructions, may cause harmful interference to radio communications. However, there is no guarantee that interference will not occur in a particular installation. If this equipment does cause harmful interference to radio or television reception, which can be determined by turning the equipment off and on, the user is encouraged to try to correct the interference by one or more of the following measures:

- 1) Reorient or relocate the receiving antenna.
- 2) Increase the separation between the equipment and the receiver.
- 3) Connect the equipment into an outlet on a circuit different from that to which the receiver is connected.
- 4) Consult the dealer or an experienced radio/TV technician for help.

Copyright Protection

Unauthorized copying, broadcasting, public performance and lending of Discs are prohibited.

This product incorporates copyright protection technology that is protected by method claims of certain U.S. patents and other intellectual property rights owned by Macrovision Corporation and other rights owners.

Use of this copyright protection technology must be authorized by Macrovision Corporation and is intended for home and other limited viewing uses only unless otherwise authorized by Macrovision Corporation. Reverse engineering or disassembly is prohibited.

Declaration of Conformity

Model Number: DVD619
Trade Name: Philips
Responsible Party: Philips Consumer Electronics
P.O. Box 14810
Knoxville, TN 37914-1810
(865) 521-4316

Manufactured under license from Dolby Laboratories. "Dolby" and the double-D symbol are trademarks of Dolby Laboratories. Confidential Unpublished Works. (© 1992-1997 Dolby Laboratories, Inc. All rights reserved.)

"DTS" and "DTS Digital Out" are trademarks of Digital Theater Systems Inc. in the United States of America. Copyright 2001 Philips Consumer Electronics. All rights reserved.

4 Table of Contents

General Information

Safety Information	3
Table of Contents	4
Introduction	5
Playable Discs	6

Getting Started

Remote Control Setup	7
Hookups	8-12
DVD Player Display	13
Front Panel	14
Rear Panel	15
Remote Control Buttons	16-17

Disc Playback and Features

Playing a Disc	18
Disc Menus	19
Pausing Playback	20
Step by Step Playback	21
Fast Forward/Reverse Search	22
Slow Motion	23
Zoom Playback	24
Track Playback	25
Title/Chapter Playback	26
Specific Time Playback	27
Repeat Playback	28
A-B Repeat Playback	29
Programmed Playback	30
Random Playback	31
Audio Language	32
Subtitle Language	33
Camera Angles	34
Parental Lock Password	35
Parental Lock Levels	36

DVD Player Setup and Features

Display Screen (DVD)	37
Display Screen (Audio CD)	38
Marker Setup Screen	39
Audio Settings	40-41
Display Settings	42-43
Language Settings	44-46

Information You May Need

Care and Maintenance	47
Helpful Hints	48-49
Specifications	50
Glossary	51
Limited Warranty	52-53
Index	54
Supplied Accessories	56

Welcome!

This Digital Video Disc Player will allow you to enjoy better picture quality, clearer sound, and endless playback features available on Digital Video Discs (DVDs). Expanding technology allows you to add options to your viewing - watch a director's cut of a movie, listen to the producer's comments, or play your favorite scene over and over again. Hear a movie in different languages, or listen only to the soundtrack. The possibilities are limited only by your choices and the materials available on the DVD.

Of course, you can listen to your favorite Audio Compact Discs on this DVD Player as well. Determine the order in which you want to hear the songs, or play the Disc repeatedly - all while seeing the status of the CD on your television.

We hope you enjoy this DVD Player and learn to use all of its features. To get the most out of the DVD Player, read this owner's manual carefully. It will describe how you can access all the features listed below.

Features

- A-B Repeat
- Audio Language choices*
- Automatic Detection of Disc type (Audio CD or DVD)
- Bit Rate display
- Display Panel with Dimmer
- Dolby Digital Sound
- DTS (Digital Theater System)
- DVD Menus in a desired language *
- Dynamic Range Control
- Markers
- On-Screen Display for DVD Player
- Parental Lock*
- Paused/Fast/Slow/Step-by-Step Playback
- Program Playback (Audio CD only)
- Random Playback (Audio CD only)
- Repeat (Chapter, Title, Track, Disc)
- Screen Saver
- Selecting a Camera Angle *
- SRS TruSurround
- Subtitles in a Desired Language *
- Time Search
- Title/Chapter Search
- Track Search
- Zoom Playback

* If available on the Disc

When referring to this manual, remember...

DVD Indicates that the feature described is available on some Digital Video Discs.

AUDIO CD Indicates that the feature described is available on some Audio Compact Discs.

Disc Menus...

Some explanations in this manual describe the Disc Menus. These menus are set by the movie producers or by the music industry; the menus will vary among Discs.

Furthermore, not all Discs have menus. However, if the Disc has a menu, you can access the Disc Menu by pressing the DISC MENU button on the remote control.

Details are on page 19.

DVD Player Menus...

Some instructions explain how to use the DVD Player's menu to set up features of the DVD Player or the Disc. You get to the DVD Player Menu by pressing the SETUP button on the remote control when Disc playback is stopped. Even if a feature is set up in the DVD Player's menu, it may not be available if the current Disc does not include that feature.





Available Disc Features...

Not all of the features described in this manual may be available on every DVD or Audio CD. If the feature is not available on the Disc, you cannot use the DVD Player to make these features available. An "X" will appear in the top right corner of the TV screen if you try to access a feature that is not available on the current Disc or not available at the current time. The "X" may not be visible if the DVD you are playing is in Widescreen format (with black bars at the top and bottom of the picture).

6 Playable Discs

Playable Discs

This DVD Player will play Digital Video Discs (DVDs) and Audio CDs. In order to play a DVD or Audio CD on this DVD Player, make sure the Disc meets the requirements for Region Codes and Color Systems as described on this page. Also, the Discs should have the following logos and should meet these standards.

Disc Type	Logo	Contents	Disc Size	Maximum Playback Time	Disc Segments
Digital Video Disc		Sound and Pictures	12 cm	Approx. 4 hours (single-sided) Approx. 8 hours (double-sided)	DVDs are divided into Titles, which are divided into Chapters. Titles and Chapters are numbered.
			8 cm	Approx. 80 minutes (single-sided) Approx. 160 minutes (double-sided)	
Audio CD		Sound	12 cm	74 minutes	Audio CDs are divided into numbered Tracks, i.e., a track may be one song.
			8 cm (singles)	20 minutes	

Region Codes

DVDs also must be labeled for ALL regions or for Region 1 in order to play on this DVD Player. You can not play Discs that are labeled for other regions.

Look for the symbols below on your DVDs. If these region symbols do not appear on your DVD, you cannot play the DVD in this DVD Player.



The number inside the globe refers to a region of the world. Region 1 represents the United States, Canada, upper regions of North America, Bermuda, the U.S. Virgin Islands, and small regions near Australia.

A Disc encoded in a specific region format can only be played on DVD Players with the same region code. For example, if a Disc is labeled for Region 2, you can not play the DVD on this DVD Player.

Color Systems

Different color systems are available throughout the world. The most common color systems are NTSC, which is used primarily in the United States and North America, PAL, and SECAM.

This DVD Player uses the NTSC color system. Therefore, the Discs that you play must be recorded in the NTSC system. You cannot play Discs recorded in other formats. The color system of the DVD may be listed on the DVD or on the Disc case.

Unacceptable Discs

If you insert an unacceptable type of disc, "Please insert a playable disc" will appear on the TV screen. Also, "- - - -" will appear on the DVD Player display panel. Insert a DVD or Audio CD. The following Discs will not play on this DVD Player.

- CD-ROM
- Compact Disc-Interactive (CD-I)
- Compact Disc-Recordable (CD-R)
- Digital Video Disc-Video Recordable (DVD-VR)
- DVD-RAM
- DVD-ROM
- Super Audio CD (SACD)
- Photo CD
- Video CD
- Video Single Disc (VSD)

The following discs might play, but only the audio will be available. There will be no picture.

- Compact Disc-Graphic (CD-G)
- Compact Disc-Video (CD-V)

Putting Batteries in the Remote Control

1

Remove the battery compartment lid on the bottom of the remote control by pressing the tab, then lifting the lid.

2

Place two AA batteries inside the battery compartment with their + and - ends aligned as indicated.

3

Replace the battery compartment lid.

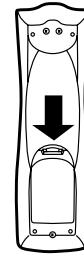

1



2

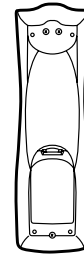

3

Using the Remote Control

- Point the remote control at the DVD Player's remote sensor (see page 14) when using the remote control to operate the DVD Player.
- Do not put objects between the remote control and the DVD Player.

Recycling Guidelines/Battery Safety

- Your new product and its packaging contain materials that can be recycled and reused. Specialized companies can recycle your product to increase the amount that needs to be properly disposed. Your product uses batteries that should not be thrown away when depleted but should be disposed of as small chemical waste. Please find out about the local regulations on disposal of your old product, batteries, and packaging whenever you replace existing equipment.
- Battery Usage CAUTION - To prevent battery leakage that may result in bodily injury or damage to the unit:
Install ALL batteries correctly, with the + and - markings on the battery aligned as indicated on the unit;
Do not mix batteries, for example, old with new or carbon with alkaline; and
Remove batteries when the unit will not be used for a long time.

8 Hookups

You may connect the DVD Player several different ways, depending on your existing equipment and your preferences for sound and picture quality. To determine which hookup is best for you, examine the options on the following pages, then see which best matches your situation. Before you hook up the DVD Player, remember:

- Connect the DVD Player directly to a TV. If you connect the DVD Player to a VCR, then connect the VCR to the TV, the picture may be distorted by the copyright protection system.
- Turn off the power of all equipment before making any connections.
- Refer to the owner's manuals of your other equipment for additional information.
- Depending on your connection, you may need to purchase additional cables.
- If you do not connect the DVD Player to a Dolby Digital or DTS Decoder, set Dolby Digital and DTS to Off on the DVD Player. *Details are on pages 11 and 40-41.* Playing a DVD when the settings are wrong will distort the sound or damage the speakers.

Connecting the DVD Player to a TV only (no stereo or amplifier) **TV has AUDIO (red and white) and VIDEO (yellow) IN jacks**

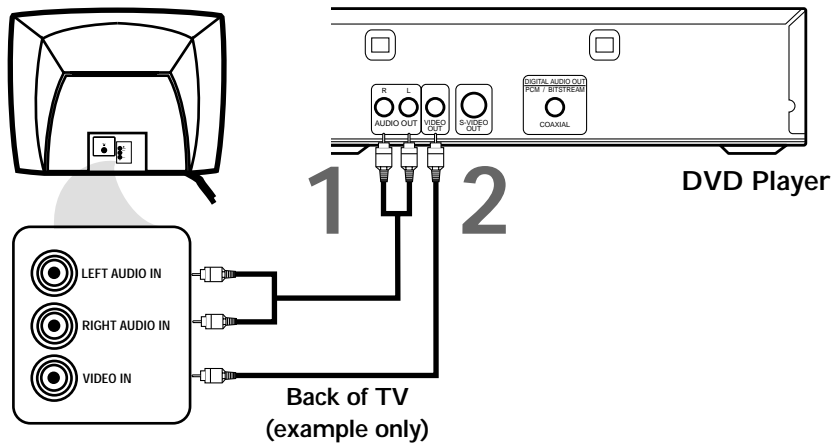

1

Connect the supplied red and white audio cables to the red and white AUDIO OUT jacks on the DVD Player and to the red and white AUDIO IN jacks on the TV, matching the cable colors to the jack colors.

2

Connect the supplied yellow video cable to the VIDEO OUT jack on the DVD Player and to the VIDEO IN jack on the TV.

3

Connect the TV's power cord to a power outlet.

Turn on the TV and set it to the Audio/Video In channel, which also may be referred to as A/V In or Auxiliary In. This channel usually is located in the vicinity of channel 00. See your TV owner's manual for details.

4

Connect the DVD Player's power cord to a power outlet.

Press the POWER button to turn on the DVD Player. "P-ON" will appear briefly on the DVD Player's display panel. You should see the DVD logo on the TV screen. If you do not, check your connections and make sure the TV is set to the correct Audio/Video In channel.

Connecting the DVD Player to a TV only (no stereo or amplifier)

TV has audio (red and white) and S-Video In jacks

- For better picture quality, use an optional S-Video cable to connect the S-VIDEO OUT jack on the DVD Player to the S-VIDEO IN jack on your TV. You will not use the VIDEO OUT jack on the DVD Player, and you will not need the supplied yellow video cable.
- Set Dolby Digital and DTS to Off on the DVD Player. *Details are on pages 40-41.* Playing a DVD when the settings are wrong will distort the sound or damage the speakers.

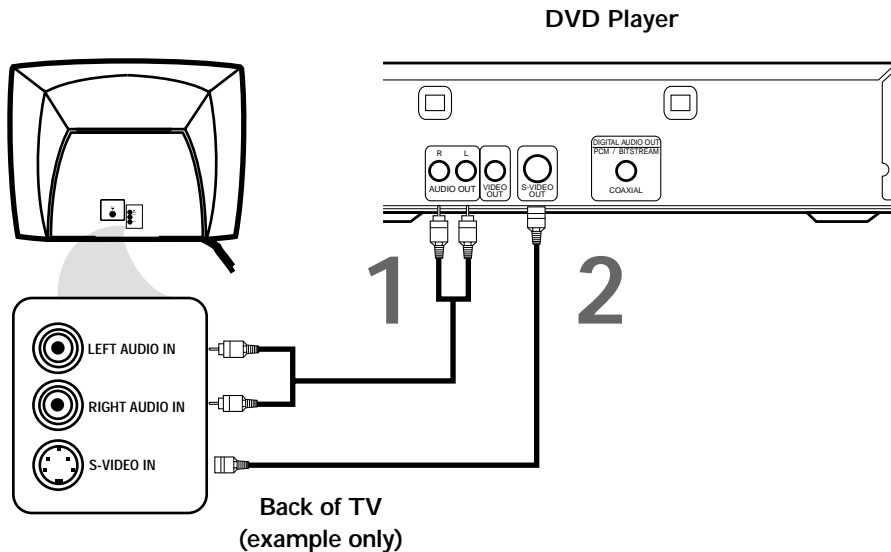

1

Connect the supplied red and white audio cables to the red and white AUDIO OUT jacks on the DVD Player and to the red and white AUDIO IN jacks on the TV, matching the cable colors to the jack colors.

2

Connect an S-Video cable (not supplied) to the S-VIDEO OUT jack on the DVD Player and to the S-VIDEO IN jack on the TV.

3

Connect the TV's power cord to a power outlet. Turn on the TV and set it to the S-VIDEO IN channel. This channel usually is located near channel 00. See your TV owner's manual for details.

4

Connect the DVD Player's power cord to a power outlet. Press the POWER button to turn on the DVD Player. "P-ON" will appear briefly on the DVD Player's display panel. You should see the DVD logo on the TV screen. If you do not, check your connections and make sure the TV is on the correct S-Video In channel.

10 Hookups (cont'd)

Connecting to a TV and a Stereo

- Set Dolby Digital and DTS to Off on the DVD Player. *Details are on pages 40-41.* Playing a DVD when the settings are wrong will distort the sound or damage the speakers.

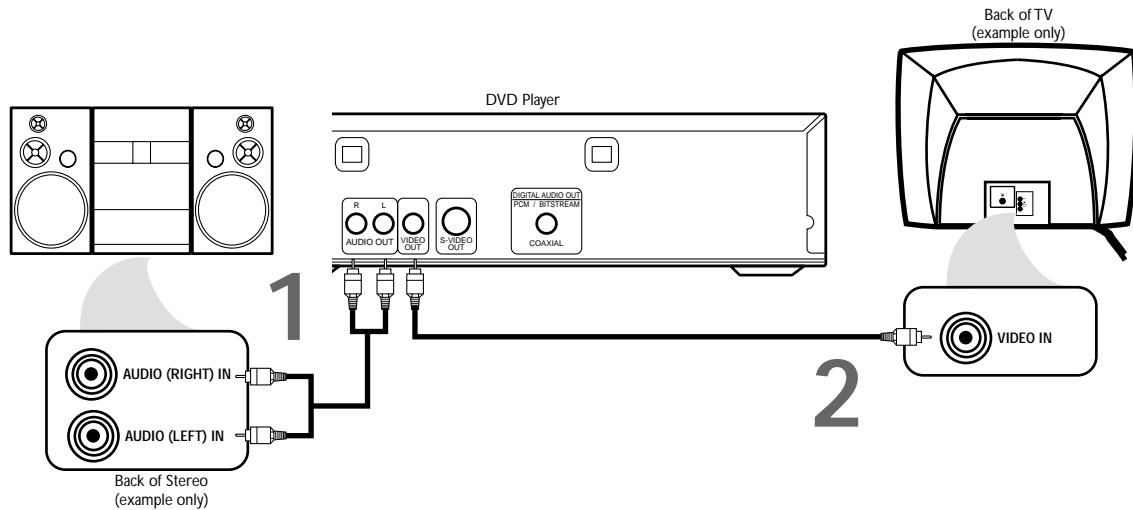

1

Connect the supplied red and white audio cables to the red and white **AUDIO OUT** jacks on the DVD Player and to the red and white **AUDIO IN** jacks on the Stereo, matching the cable colors to the jack colors.

2

Connect the supplied yellow video cable to the yellow **VIDEO OUT** jack on the DVD Player and to the **VIDEO IN** jack on the TV. (Or, you may connect an optional S-Video cable to the S-VIDEO OUT jack on the DVD Player and to the S-VIDEO IN jack on the TV. Only one video connection is needed.)

3

Plug in the Stereo's power cord. Turn on the Stereo and select the Stereo's **Auxiliary IN** station. During Disc playback, you will adjust the volume at your Stereo. See your Stereo owner's manual for details.

4

Plug in the TV's power cord. Turn on the TV and set it to the **Video In** channel (or **S-Video In** channel), which usually is located near channel 00. During Audio CD playback, you may check the status of Audio CDs on your TV screen. During DVD playback, you will watch the program on the TV. See your TV owner's manual for details.

5

Connect the DVD Player's power cord to a power outlet. Press the **POWER** button to turn on the DVD Player. "P-ON" will appear briefly on the DVD Player's display panel. You should see the DVD logo on the TV screen. If you do not, check your connections and make sure the TV is on the correct Video In channel.

Connecting to a Dolby Digital Decoder or DTS Decoder

Some Discs are recorded in a 5.1 channel Dolby Digital Surround or Digital Theater System (DTS) Surround format. These Discs will sound best if you connect the DVD Player to a Dolby Digital or DTS Decoder.

- You will need a coaxial digital audio cable (not supplied).
- If you connect the DVD Player to a Dolby Digital Decoder, set Dolby Digital to On. *Details are on pages 40-41.*
- If you connect the DVD Player to a DTS Decoder, set DTS to On. *Details are on pages 40-41.*
If you do not connect the DVD Player to a Dolby Digital or DTS decoder, set Dolby Digital and DTS to Off. Incorrect settings may cause noise distortion and damage the speakers.
- Select 5.1 channel Dolby Digital Surround sound in the Disc menu.
- Connect a subwoofer and the center, front, and surround speakers to the Decoder as described in the Decoder's owner's manual.

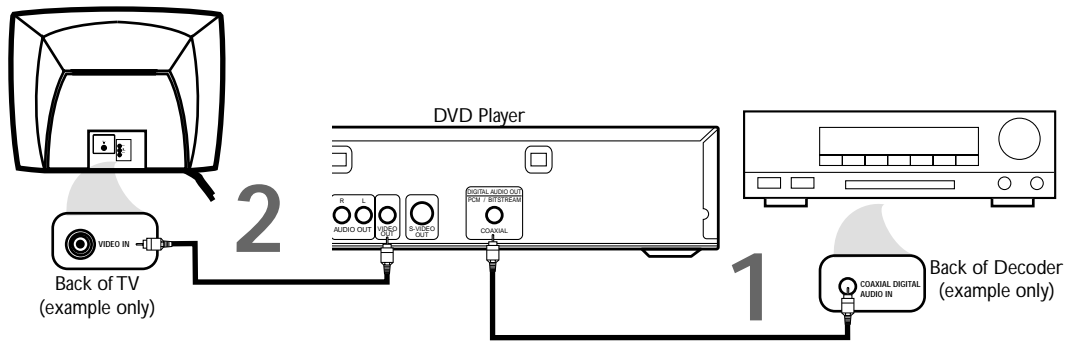

1

Connect a coaxial digital audio cable to the **COAXIAL** jack on the DVD Player and to the **COAXIAL DIGITAL AUDIO IN** jack on the Decoder.

2

Connect the supplied yellow video cable to the yellow **VIDEO OUT** jack on the DVD Player and to the **VIDEO IN** jack on the TV. (Or, you may connect an optional S-Video cable to the **S-VIDEO OUT** jack on the DVD Player and to the **S-VIDEO IN** jack on the TV. Only one video connection is needed.)

3

Plug in the Decoder's power cord. Turn on the Decoder and select the **Auxiliary IN** station. During Disc playback, you will adjust the volume at the Decoder. See your Decoder owner's manual for details.

4

Plug in the TV's power cord. Turn on the TV and set it to the correct **Video In** channel. During Audio CD playback, you may check the Disc status on your TV screen. During DVD playback, you will watch the program on the TV. See your TV owner's manual for details.

5

Connect the DVD Player's power cord to a power outlet. Press the **POWER** button to turn on the DVD Player. "P-ON" will appear briefly on the DVD Player's display panel. You should see the DVD logo on the TV. If you do not, check your connections and make sure the TV is on the correct Video In channel.

12 Hookups (cont'd)

Connecting to a TV and an Amplifier with Digital Input jacks, Mini-Disc Deck or Digital Audio Tape Deck

- Use a coaxial digital audio cable (not supplied) for this connection.
- If the Disc is recorded in 5.1 channel Dolby Digital Surround, you cannot dub the Disc in digital sound using a Mini-Disc or Digital Audio Tape Deck.
- Set Dolby Digital and DTS to Off on the DVD Player. *Details are on pages 40-41.* Playing a DVD when the settings are wrong will distort the sound or damage the speakers.

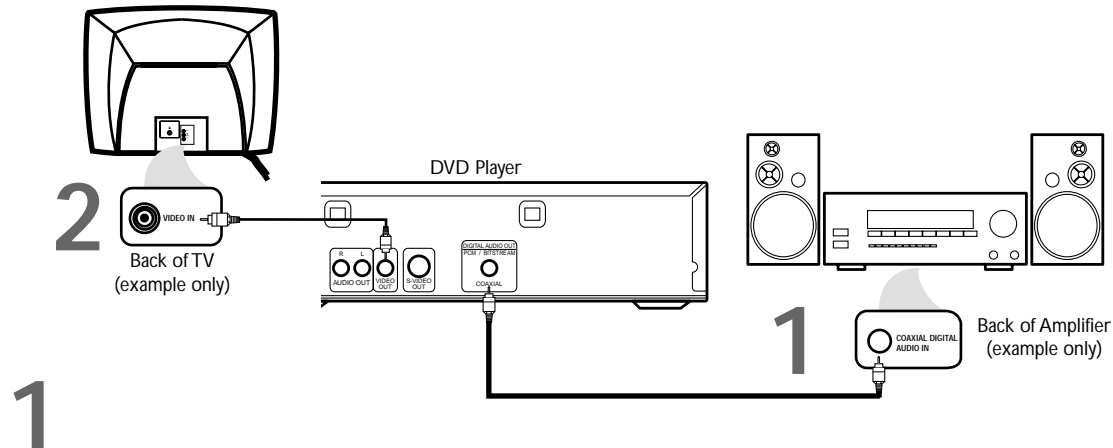

1 Connect a coaxial digital audio cable to the **COAXIAL** jack on the DVD Player and to the **COAXIAL DIGITAL AUDIO IN** jack on the Amplifier.

2 Connect the supplied yellow video cable to the yellow **VIDEO OUT** jack on the DVD Player and to the **VIDEO IN** jack on the TV. (Or, you may connect an optional S-Video cable to the S-VIDEO OUT jack on the DVD Player and to the S-VIDEO IN jack on the TV. Only one video connection is needed.)

3 Plug in the Amplifier's power cord. Turn on the Amplifier and select the **Auxiliary IN** station. During Disc playback, you will adjust the volume at the Amplifier. See your Amplifier owner's manual for details.

4 Plug in the TV's power cord. Turn on the TV and set it to the correct **Video In** channel. During Audio CD playback, you may check the status of the Disc on your TV screen. During DVD playback, you will watch the program on the TV. See your TV owner's manual for details.

5 Plug in the DVD Player's power cord. Press the **POWER** button to turn on the DVD Player. "P-ON" will appear briefly on the DVD Player's display panel. You should see the DVD logo on the TV. If you do not, check your connections and make sure the TV is on the correct Video In channel.

Helpful Hints

- Insert cable plugs firmly into the jacks when making connections.
- If a plug has minor scratches or is dirty, clean it with a soft cloth before inserting it into a jack.

DVD Player Display 13

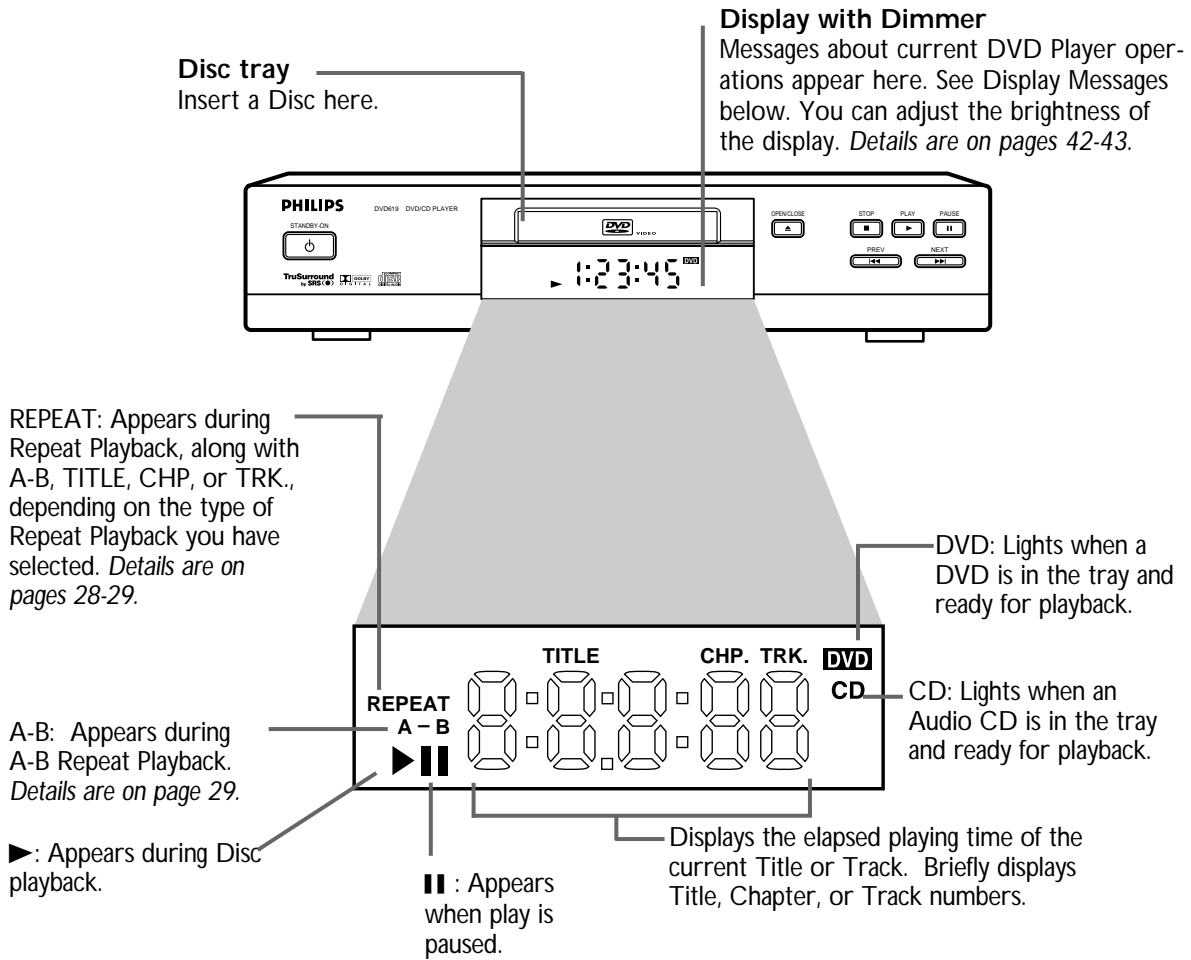

Display Messages

P - 00	Power is turning on.
- - - -	Appears after the disc tray closes if the tray is empty, if there is an error reading the disc, or if an unacceptable disc is installed.
OPEN	Tray is opening or is open.
CLOSE	Tray is closing. This also may appear as the Player tries to load a Disc.
Load	Disc is loading.
P - OFF	Power is turning off.

14 Front Panel

PAUSE Button

Press to pause Disc playback.
Details are on page 20.

PLAY Button

Press to start or resume Disc playback.
Details are on page 18.

STOP Button

Press to stop Disc playback.
Details are on page 18.

OPEN/CLOSE Button

Press to open or close the Disc tray.
Details are on page 18.

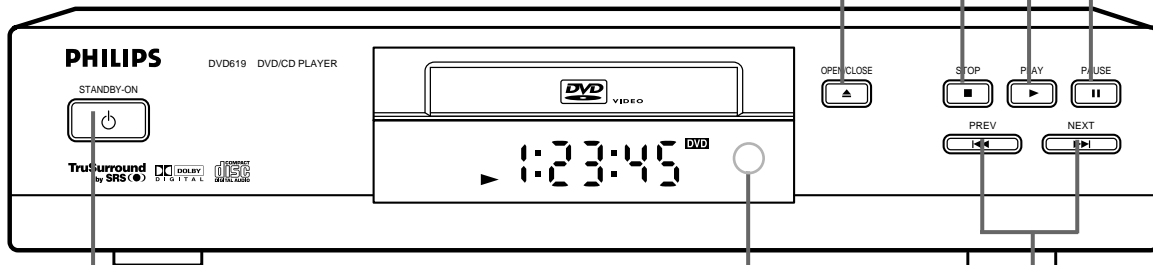

Remote Sensor

Receives a signal from your remote control so you can operate your DVD Player from a distance.

STANDBY-ON Button

Press to turn the power on and off.
Details are on page 18.

PREV(ious)/NEXT

Press to go to previous or subsequent Tracks or Chapters. Press and hold for about three seconds for a fast forward or reverse search.
Details are on page 22.

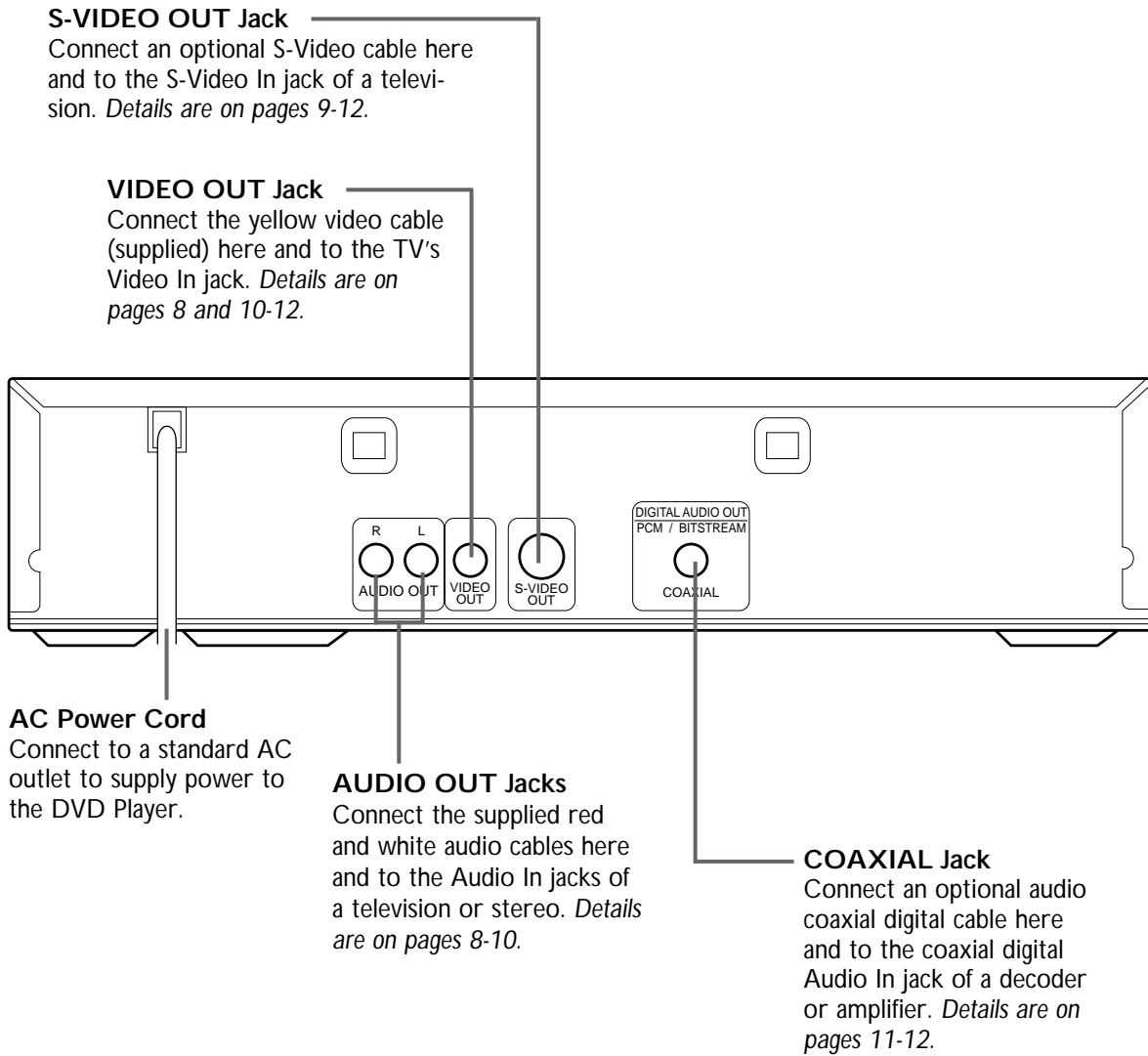

Helpful Hint

- You only need one audio connection and one video connection, so you will not have a cable connected to every jack. For example, if you are using the S-VIDEO OUT jack, you will not use the VIDEO OUT jack.

16 Remote Control Buttons

POWER Button
Press to turn the power on and off. "P-ON" appears briefly on the display panel as the DVD Player turns on. "P-OFF" appears briefly as the DVD Player turns off.

AUDIO Button
Press to choose one of the audio languages or sound modes available on the Disc. *Details are on page 32.*

OPEN/CLOSE Button
Press to open or close the Disc tray.

SETUP Button
When Disc playback is stopped, press to access or remove the DVD Player's Setup menu. *Details are on pages 35-36 and 40-46.*

REPEAT Button
Press to repeat playback of the current Disc or Track (Audio CD) or a Title or Chapter (DVD). *Details are on page 28.*

SEARCH MODE Button
Press to access or remove the Search display, which allows you to go directly to a specific Title/Chapter/Track/Time. *Details are on pages 25-27.*

RETURN Button
Press to return to the previous DVD Player Setup menu or to remove the Setup menu from the TV screen.

Skip ►► and ◀◀ Buttons
Press to skip Chapters or Tracks. *Details are on page 25.*

DISC MENU Button
Press to display the menu of the Disc. *Details are on pages 5 and 19.*

Stop ■ Button
Press to stop Disc play.

Reverse ◀◀ Button
Press to view the picture in fast reverse motion (DVD) or to reverse playback of an Audio CD. *Details are on page 22.*

Number Buttons
Press to directly select a Track (Audio CD) for playback. *Details are on page 25.* For single-digit Tracks, press a single Number button. For example, to play Track three, press the Number 3 button.
For Tracks 10 and above, press the +10 button so that the Search display appears. Then, press the Number button for the first digit, then a Number button for the second digit. For example, to play Track 12, press the +10 button, then the Number 1 button, then the Number 2 button. For Track 22, press the +10 button, then press the Number 2 button twice.
Also, you can use the Number buttons to program Tracks (Audio CD) for playback. *Details are on page 30.*

Play ► Button
Press to begin Disc play.

Arrow Buttons
Press to select an item in the DVD Player menu or in the Disc menu.

OK Button
Press to confirm a setting in the Player menu or to select a feature in the Disc menu.

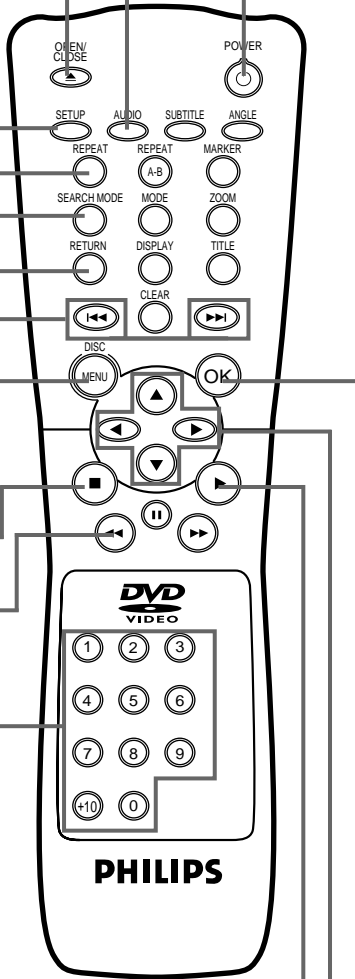

Remote Control Buttons (cont'd) 17

ANGLE Button
Press to view the picture from a different angle (if available). Press to choose one of the available angles. *Details are on page 34.*

SUBTITLE Button
Press to select a language for the subtitles (among those available) or to turn off the subtitles. *Details are on page 33.*





A-B REPEAT Button
Press to set up A-B Repeat Play, which repeatedly plays a specific segment of a Disc. *Details are on page 29.*

MODE Button
Press to set up programmed or random playback for an Audio CD. *Details are on page 30-31.*

DISPLAY Button
Displays the current status of the Disc during playback. Press again to remove the status display. *Details are on pages 37-38.*

CLEAR Button
Press to erase incorrect information when setting up features.

Pause  Button
Press to pause Disc playback. *Details are on page 20.* Press repeatedly to advance the DVD picture step by step (or one frame at a time). *Details are on page 21.*

Fast Forward  Button
Press to fast forward the Disc. *Details are on page 22.*
Press the Pause  button, then press the Fast Forward  button to begin slow motion playback. Press the Fast Forward  button repeatedly to change the forward speed of slow motion. *Details are on page 23.*

TITLE Button
Press to display the Title menu of the Disc, if available. *Details are on page 19.*

ZOOM Button
Enlarges the DVD picture during playback. *Details are on page 24.*

MARKER Button
Press to set a Marker, which will give you quick access to points on a Disc that you select. *Details are on page 39.*

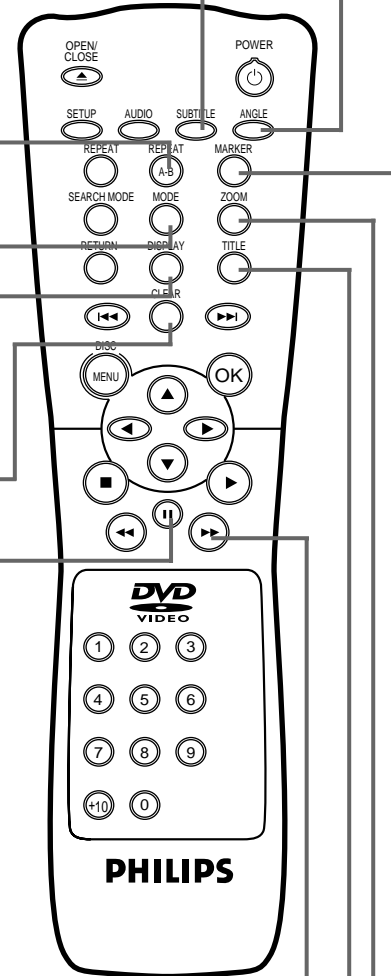

18 Playing a Disc

DVD

AUDIO CD

Playing a DVD or an Audio CD

Before you begin...

Turn on the power of the TV, amplifier and any other equipment connected to the DVD Player. Make sure the TV and the stereo or amplifier (if applicable) are set to the correct channel. *Details are on pages 8-12.*

1

Press the **POWER** button to turn on the DVD Player. "P-ON" will appear briefly on the display panel.

2

Press the **OPEN/CLOSE** button to open the Disc tray.

3

Place a **Disc into the tray**. Make sure the Disc is sitting properly in the recessed groove of the tray.

Some DVDs are recorded on both sides. Make sure the side you want to play is facing up. Or, if the DVD is recorded on only one side, place the Disc in the tray with the label facing up.

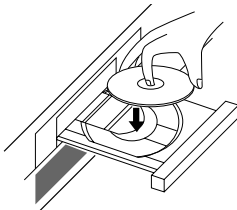

4

Press the **OPEN/CLOSE** button to close the tray. Disc playback may start automatically. Or, if the DVD has a menu, the menu may appear on the screen instead. *Details are on page 19.* With some Audio CDs, playback will not begin until you press the **Play** button.

To search forward or backward during playback, see page 22.

5

Press the **Stop** button to stop playback.

Remember, this DVD Player will play only certain Discs. See page six for details.

3 Insert a Disc.

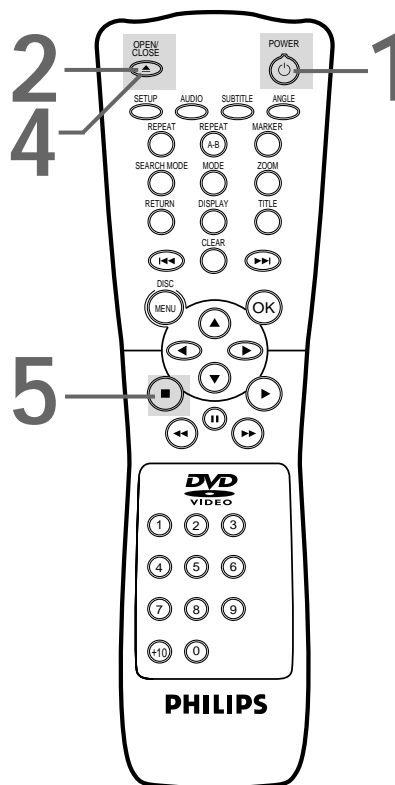

Helpful Hints

- An "X" may appear at the top right corner of the TV screen when you try a feature. This means either the feature you tried is not available on the Disc, or the DVD Player can not access the feature at this time. This does not indicate a problem with the DVD Player.
- If a Disc is dirty or has scratches, the pictures may appear distorted and playback may stop. In such cases, remove the Disc and turn off the DVD Player. Unplug the power cord, then reconnect it to the power outlet. Clean the Disc, then turn on the DVD Player again and reinsert the Disc for playback.
- When the DVD or CD light appears on the display panel, the Disc is loaded completely and is ready for playback.

DVD

Using the DVD Menus

Some DVDs contain menus that describe the contents of the Disc or allow you to customize Disc playback. For example, the menu may offer choices for subtitle languages, director's commentary, or soundtrack playback.

To use the DVD menu and select playback features, follow these steps.

1

Press the **DISC MENU** button. The DVD's main menu will appear.

2

Press the **Arrow buttons** **▲▼◀▶** to select an item, then press the **OK** button. Continue this process to set up all the features you wish to see on the Disc.

To access the DVD's Main Menu...

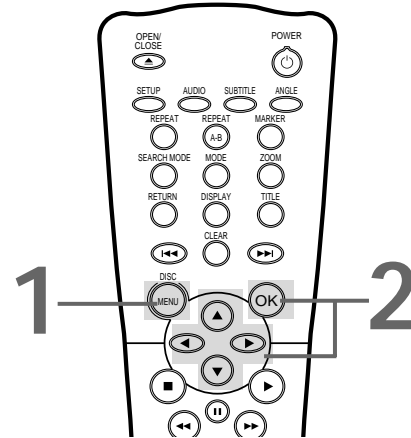

Using the Title Menu

Some DVDs have a Title Menu, which lists the Titles available on the Disc. Use the Title Menu to start playback at a specific Title. Some DVDs may allow you to choose Chapters from the Title menu.

For example, if a DVD has 10 Titles and you want to go directly to Title 5, follow these steps.

1

Press the **TITLE** button. The Title Menu will appear.

If a Title menu is not available, the "X" may appear on the TV screen. If the DVD only has a main menu, the main menu may appear when you press the TITLE button.

2

Press the **Arrow buttons** **▲▼◀▶** to select the desired Title, then press the **OK** button.

Playback will begin at the Title you selected.

To access the DVD's Title Menu...

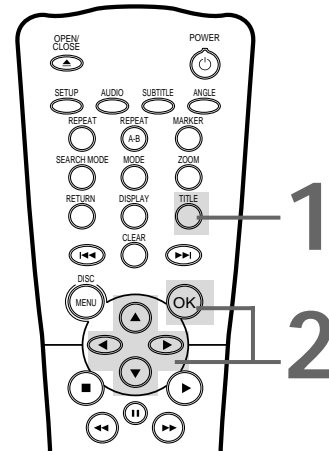

Helpful Hints

- Menus may vary among Discs. Refer to the literature accompanying the Disc for details.
- Not all DVDs have Title menus.
- Some DVDs may refer to Chapters as "scenes." Some DVDs may refer to the Title Menu as the "scene index."

20 Pausing Playback

DVD

AUDIO CD

Pausing Playback

1

During playback, press the Pause **||** button on the remote control (or press the PAUSE button on the DVD Player). Playback will pause and the sound will be muted. If you press the Pause **||** button repeatedly, the picture will advance one frame at a time with each button press.

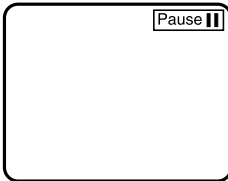

2

Press the Play **▶** button to resume playback.

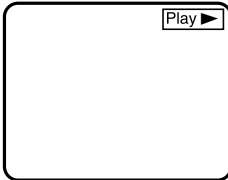

Pausing Playback...

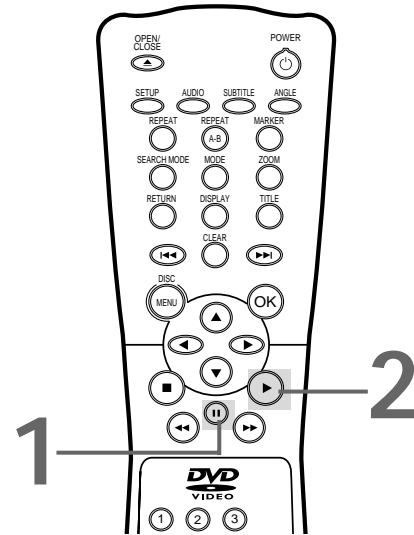

DVD

Resume On: Resuming playback from the point at which playback stopped

1

Press the Stop **■** button during playback. In a few seconds, the following Resume message will appear on the TV screen.

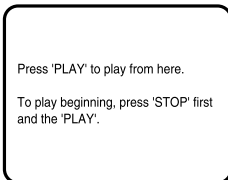

2

Press the Play **▶** button. In a few seconds, playback will resume from the point at which playback stopped last.

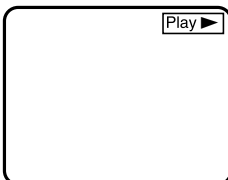

Resuming Playback...

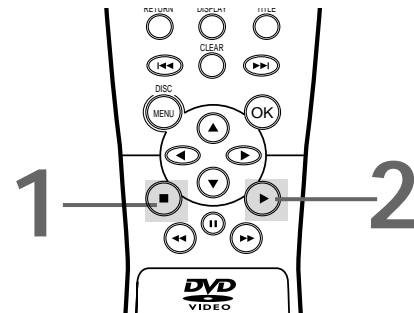

Helpful Hint

- To cancel resume playback and start playing the DVD from the beginning, press the Stop **■** button a second time while playback is stopped. Resume Off will appear briefly at the top right corner of the TV screen. Press the Play **▶** button to start playing the DVD.

Step by Step Playback 21



DVD

1

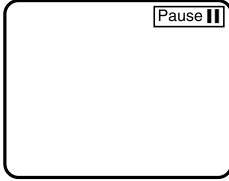
During playback, press the **Pause**  button to pause playback. The sound will be muted.



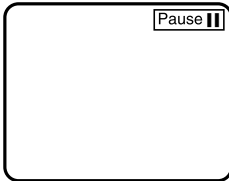

2

Press the **Pause**  button repeatedly to see the picture advance one frame (or step) at a time. The sound will remain muted. **Pause**  will appear briefly on the screen each time you press the **Pause**  button.



3

Press the **Play**  button to resume playback. **Play**  will appear briefly on the TV screen.

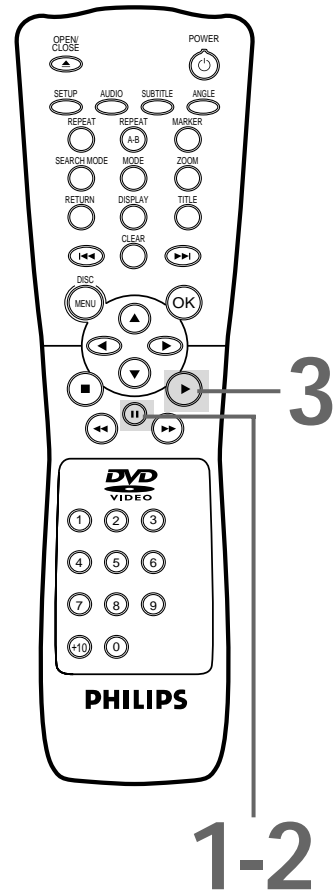
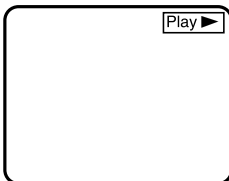

22 Fast Forward/Reverse Search

DVD

AUDIO CD

1

During playback, press the Fast Forward **▶▶** button or the Reverse **◀◀** button on the remote control (or press and hold the NEXT button or the PREV(ious) button on the DVD Player).

- On a DVD, pressing the Fast Forward **▶▶** or Reverse **◀◀** button repeatedly will forward or reverse the picture at twice, eight times, or 32 times the normal playback speed. Sound will be muted during searching.
- Use the Fast Forward **▶▶** button for a forward search. Press the Reverse **◀◀** button for a reverse search.

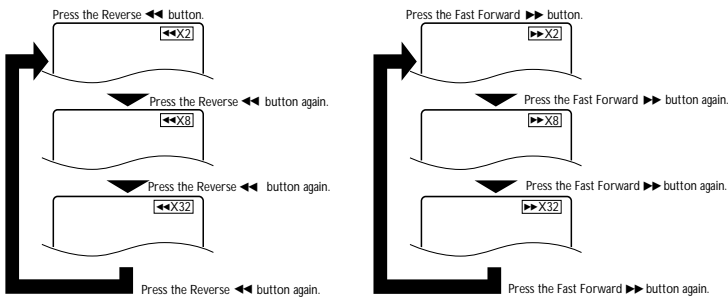

- On an Audio CD, you may search forward or backward at 16 times the normal playback speed (**◀◀X16** or **▶▶X16**). Pressing the Fast Forward **▶▶** or Reverse **◀◀** button repeatedly will not affect the speed of the search. Sound will be intermittent during searching on an Audio CD.
- Use the Fast Forward **▶▶** button for a forward search. Press the Reverse **◀◀** button for a reverse search.

Press the Reverse **◀◀** button during Audio CD playback.



Press the Fast Forward **▶▶** button during Audio CD playback.



2

Press the Play **▶** button to return to normal playback.

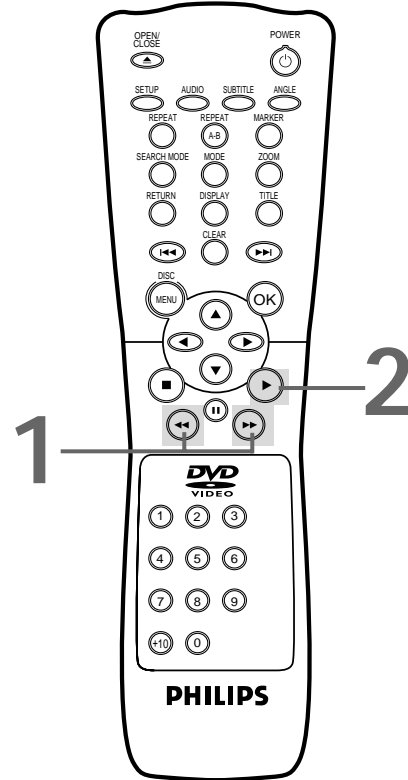

DVD

1

Press the **PAUSE**  button during playback.

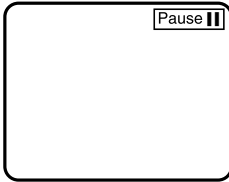

2

Press the **Fast Forward**  button. Slow motion playback will begin.

Press the **Fast Forward**  button repeatedly during slow motion playback to vary the speed of slow motion playback.

You may play the DVD at 1/16, 1/8, or 1/2 the normal playback speed.

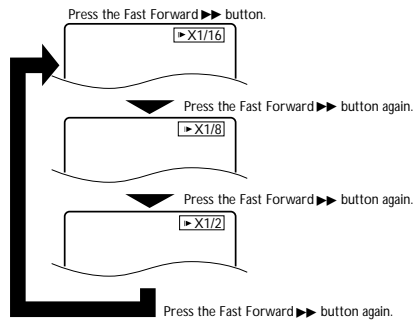

3

Press the **Play**  button to return to normal playback.

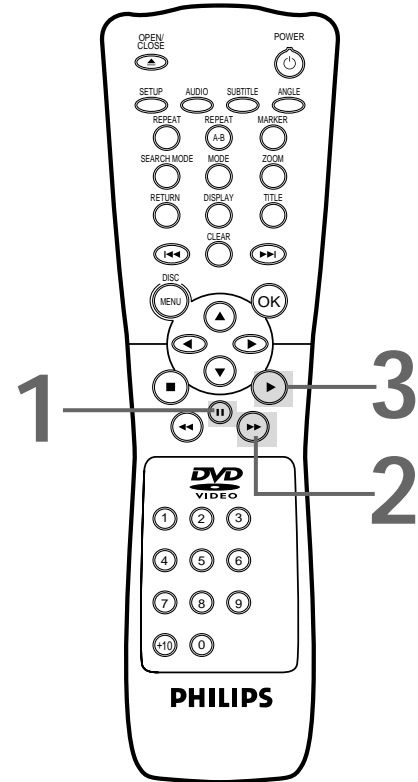
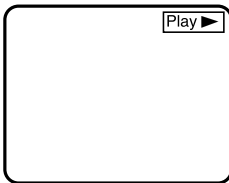

Helpful Hints

- The sound will be muted when playback is paused and during slow motion playback.
- You can not play the DVD in reverse slow motion.

24 Zoom Playback

DVD

You can enlarge the DVD picture during playback. The picture will be four times larger than normal.

1

Press the **ZOOM** button during playback. The enlarged picture will continue to play.

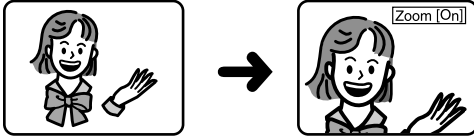

2

Press the Arrow buttons **▲▼◀▶** to move the zoomed image left, right, up, and down.

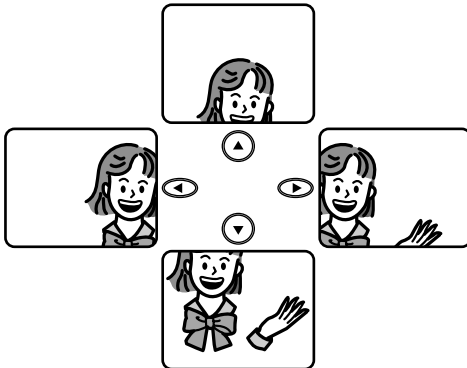

3

To return the picture to its normal size, press the **ZOOM** button again.

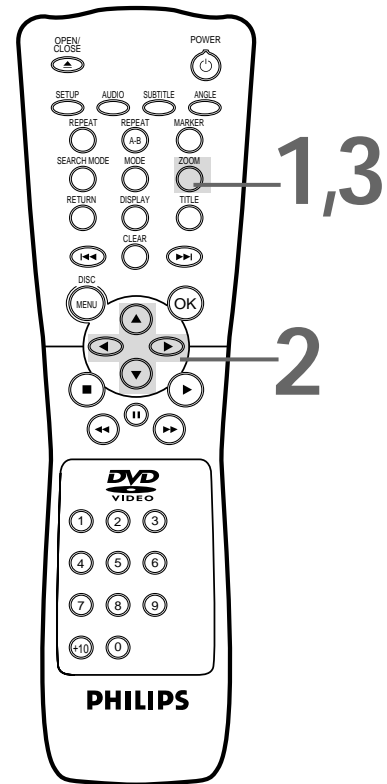
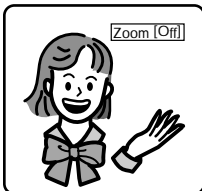

Helpful Hint

- Zooming is not possible when you access the DVD Player's display screen. Details are on page 37.

AUDIO CD

Starting Playback at a Specific Track

There are three ways to begin playback on an Audio CD at a specific Track. You may use the Number buttons, the SEARCH MODE button, or the Skip **⏮****⏭** buttons. For details, read this information.

A

Using the Number Buttons to Select a Track

Press the **Number** buttons to enter the desired **Track number**. Playback will start at the selected Track. You may select a Track with the Number buttons during playback or when playback is stopped.

For single-digit Tracks (1-9), press a single Number button. For example, to play Track three, press the Number 3 button.

For Tracks 10 and above, press the +10 button so that the Search display appears on the TV screen. Then press the Number button of the first digit, then press the Number button of the second digit.

For example, to play Track 26, press the +10 button, then press the Number 2 button, then press the Number 6 button.

If you enter a Track number that is not available on the Disc, playback will not begin (or the current Track will continue to play). An "X" will appear in the top right corner of the TV screen.

B

Using the SEARCH MODE Button to Select a Track

Press the **SEARCH MODE** button once so that the **Track Search display** appears. **Within 30 seconds**, press the **Number** buttons to select the **Track number** you desire. **Playback will begin at the selected Track**. For a single-digit Track (1-9), enter a zero first. For example, to play Track 5, press 0, 5.

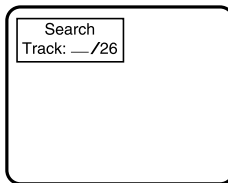

C

Using the Skip **⏮****⏭** Buttons to Select a Track

Press the **Skip **⏭**** button during playback to skip the current Track and move to the next Track. Press the **Skip **⏭**** button repeatedly to skip subsequent Tracks. The Track number will appear briefly on the DVD Player display panel.

Press the **Skip **⏮**** button during playback to return to the beginning of the current Track. Press the **Skip **⏮**** button repeatedly to go to previous Tracks. The Track number will appear briefly on the DVD Player display panel.

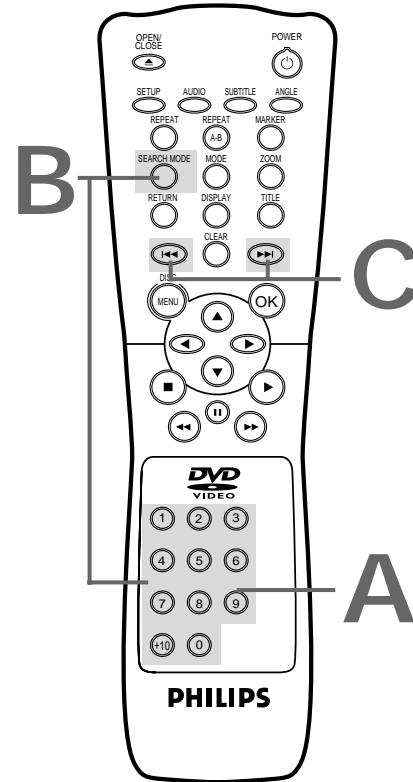

Helpful Hints

- The Skip **⏭** buttons are not active when playback is stopped.
- You can not use the Skip **⏭** button to go from the last Track on the disc to the first Track.

26 Title/Chapter Playback

DVD

Starting Playback at a Specific Title/Chapter

1

Press the **SEARCH MODE** button so that the Title/Chapter Search display appears on the TV screen.

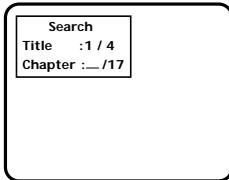

2

To select the Title, press the **Arrow ▲** button to select the Title space, then press the **Number** buttons to enter the Title number. The bar will move to Chapter automatically.

- For a single digit, 1-9, press 0 first. For example, to select Title 4, press 0, 4.

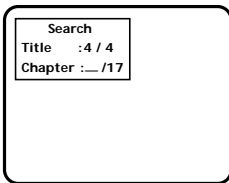

3

To select the Chapter, press the **Number** buttons to enter the Chapter number. The DVD Player will begin playback at the selected Chapter.

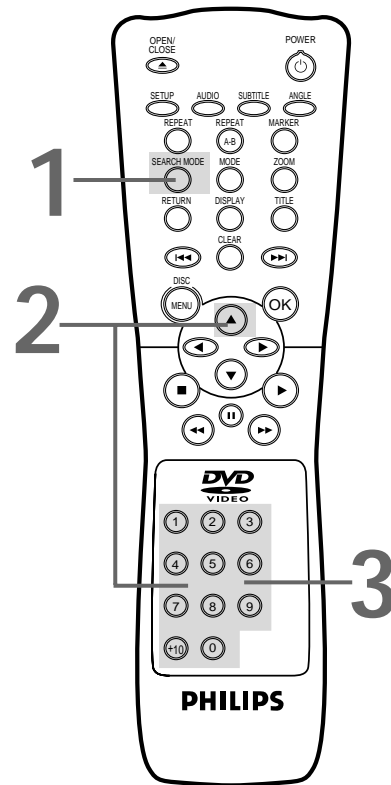
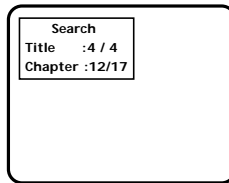

Helpful Hint

- Title/Chapter playback is not available with some DVDs.

DVD

AUDIO CD

Starting Playback at a Specific Disc Time

1

During playback, press the **SEARCH MODE** button repeatedly so that the Time Search display appears on the TV screen.

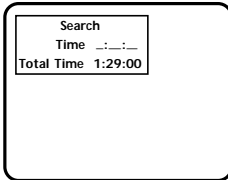

2

Within 30 seconds, use the **Number** buttons to enter the **Disc time at which you want playback to begin**. Within a few seconds, playback will start at the specified time.

- Example: 1 hour, 23 minutes and 30 seconds
1 → 2 → 3 → 3 → 0
- Make sure the time you enter is within the total time of the Title or Track. If it is not, "X" will appear on the screen. Playback will continue at its current point.
- If you make a mistake, press the **CLEAR** button. Then, enter the correct information.

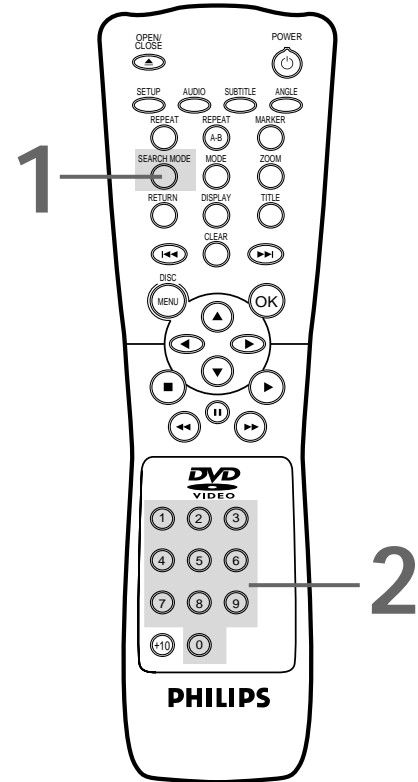

28 Repeat Playback

1

Press the REPEAT button repeatedly until the repeat mode you want appears in the top left corner of the TV screen.

DVD

- Repeatedly pressing the REPEAT button during playback lets you choose Repeat Title, Repeat Chapter, or Repeat Off.
- Selecting a new Chapter or Title will cancel repeat playback.

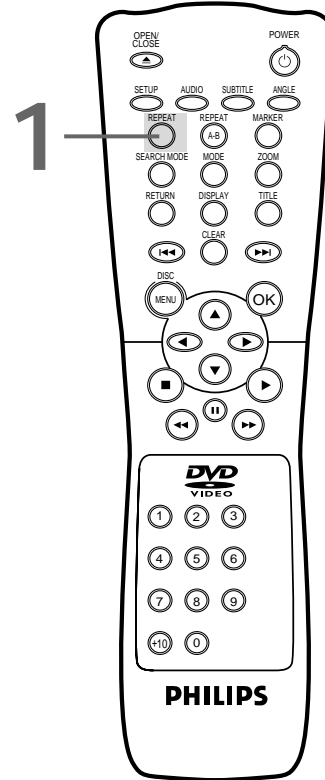
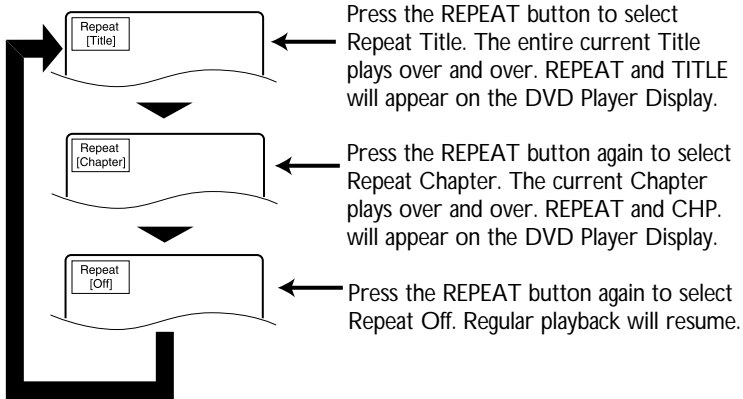

AUDIO CD

- Repeatedly pressing the REPEAT button during playback lets you choose Repeat All, Repeat Track, or Repeat Off.
- Selecting a new Track will cancel repeat playback.

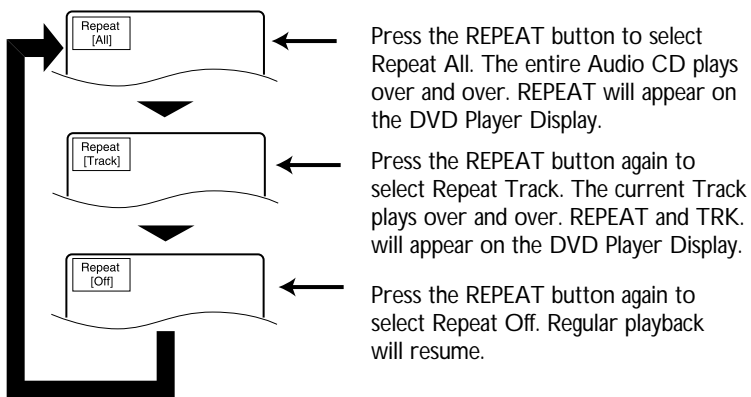

Helpful Hint

- Repeat playback is not available with some discs.

DVD

AUDIO CD

You can play a section of an Audio CD or DVD repeatedly. Follow these steps to set up the section that you want to play over and over.

1

Play the Disc to the point at which you want repeated playback to begin.

2

Press the **A-B REPEAT** button to set the starting point (A). Repeat A will appear on the DVD Player's display panel.

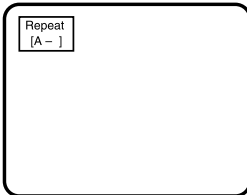

3

Play the Disc to the point at which you want repeated playback to end, then press the **A-B REPEAT** button again.

Within a few seconds, the section will begin to play. The segment will play over and over until you cancel the A-B Repeat feature. REPEAT A-B will appear on the DVD Player's display panel.

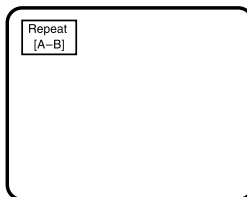

4

To cancel A-B Repeat Playback, press the **A-B REPEAT** button so that Repeat [Off] appears on the TV screen. Regular Disc playback will resume.

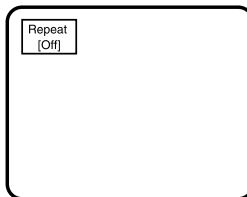

2-4

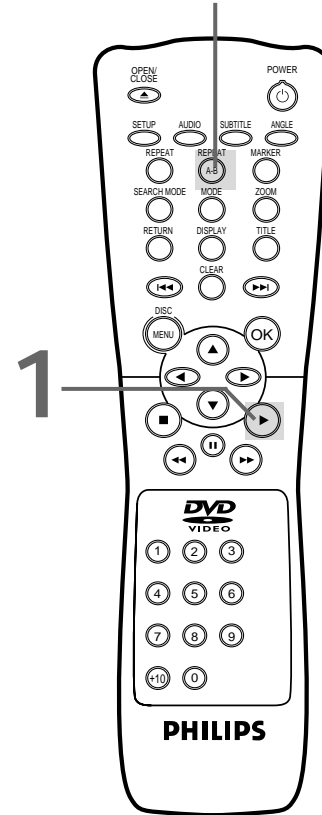

Helpful Hints

- A-B Repeat playback is not available with some DVDs.
- With DVDs, the entire A-B repeat section must be within a single Title. The DVD Player will automatically set the end point (B) at the end of the Title.
- With Audio CDs, the A-B repeat section must be within a single Track. The DVD Player will automatically set the end point (B) at the end of the Track.
- Point B must be later on the Disc than Point A.
- Pressing the Stop ■ button will cancel A-B Repeat Playback.

30 Programmed Playback

AUDIO CD

You may determine the order in which Tracks will play. The order that you set is called the Program. To set up programmed playback, follow these steps.

1

While playback is stopped, press the **MODE** button. The program screen will appear.

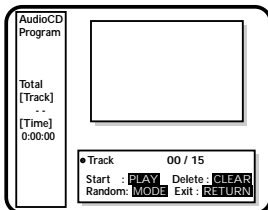

2

Press the **Number** buttons to enter the number of the first Track that you want to play.

- If you enter a wrong Track number, press the **CLEAR** button. The last Track in the Program will be removed.
- Enter single-digit Tracks with a single **Number** button. For example, for Track three, press the **Number 3** button.
- For Tracks 10 and above, press the **+10** button, then the **Number** button for the first digit, then the **Number** button for the second digit. For example, to play Track 26, press the **+10** button, then press the **Number 2** button, then press the **Number 6** button.

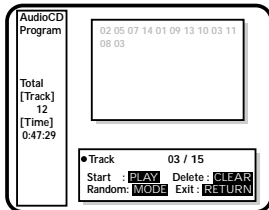

3

Repeat step 2 until you have selected all the Tracks you wish to play in the Program.

- Make sure the Track numbers you enter are available on the Audio CD.

4

Press the **Play** button. The Tracks will play in the order in which you programmed them. The Program will play once. When programmed playback ends, the Program will be erased. Turning off the Player or opening the disc tray also will erase the Program.

2-3

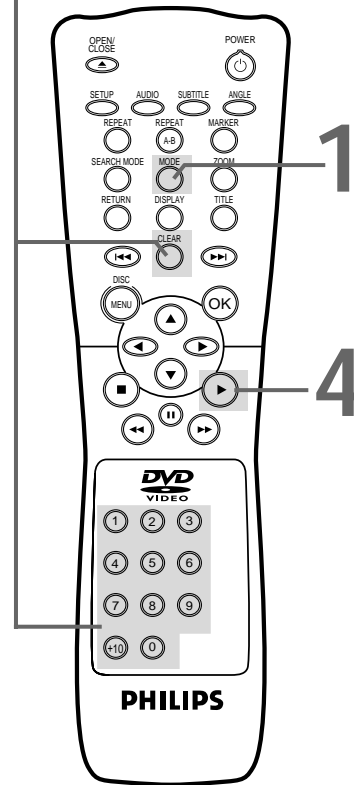

Helpful Hints

- You can not combine specific track and random playback with programmed playback.
- You may play a Program repeatedly. During programmed playback, press the **REPEAT** button so that Repeat [All] or Repeat [Track] appears. The entire program or the current Track will play over and over.
- To see which Tracks you stored in the Program, press the **DISPLAY** button during playback.

AUDIO CD

You may play the Tracks of an Audio CD in Random order instead of the order in which they are recorded (1,2,3...). To set up Random Playback, follow these steps.

1

While playback is stopped, press the **MODE** button twice so that the **RANDOM** screen appears.

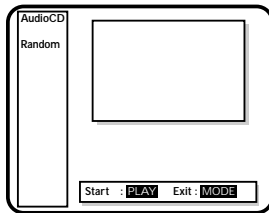

2

While the **RANDOM** screen appears, press the **Play** button. The Tracks will play in random order. After each Track plays once, playback will stop.

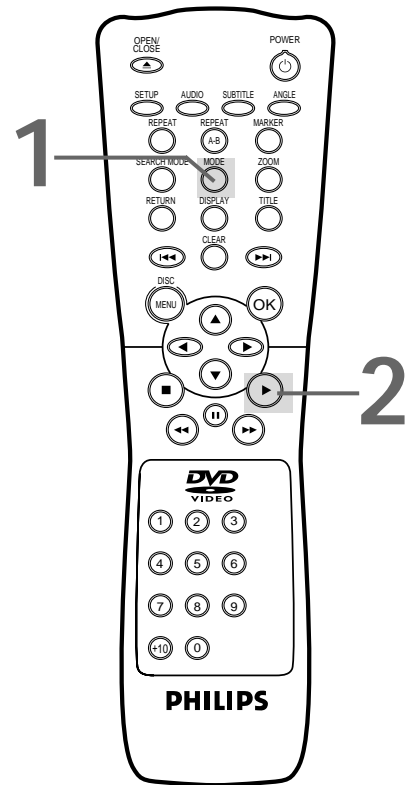

32 Audio Language

DVD

The DVD Player allows you to select a language for DVDs during playback. You can change the language only if multiple languages are available on the DVD.

1

Press the **AUDIO** button during playback so that the **audio display** appears in the top left corner of the TV screen. Press the AUDIO button repeatedly until you select your desired language.

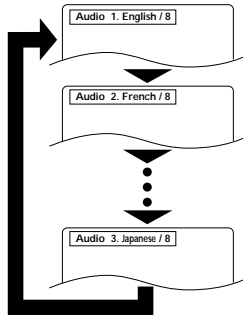

Press the AUDIO button.

Press the AUDIO button again.

Press the AUDIO button repeatedly to see and hear all the available languages. The number of available languages appears at the right of the audio display. In this example, eight languages are available (/ 8).



AUDIO 1

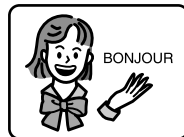

AUDIO 2

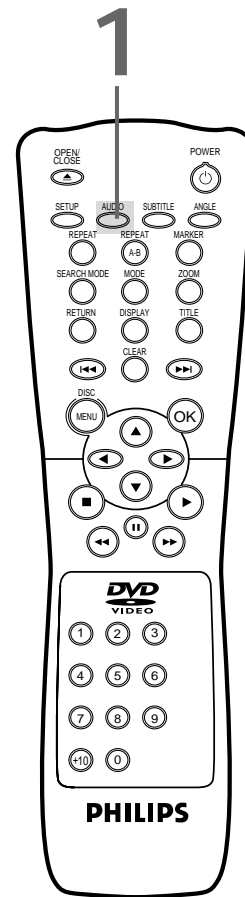

Helpful Hints

- If a desired language is not available after pressing the AUDIO button several times, the DVD does not have that language.
- The display will disappear after about 5 seconds.
- Some DVDs only allow you to change the language in the Disc menu.

DVD

The DVD Player allows you to select a language for subtitles during playback. You may select only the languages that are available on the Disc.

1

Press the **SUBTITLE** button during playback so that the subtitle display appears on the TV screen.

2

Within 5 seconds, press the **SUBTITLE** button repeatedly to select a subtitle language. The number of available languages appears at the right of the audio display. In this example, eight languages are available (/8).

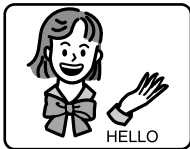
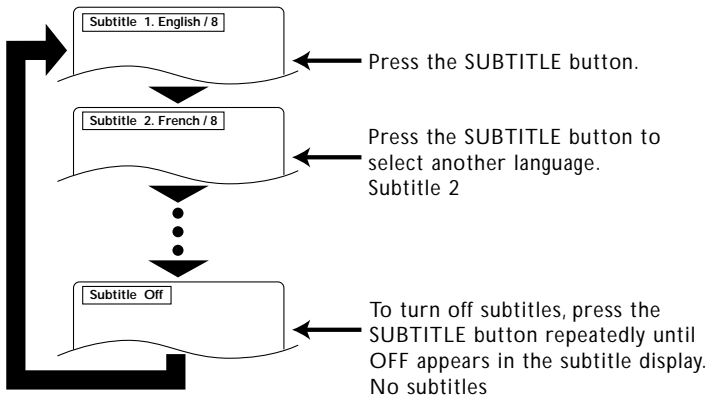

SUBTITLE 1

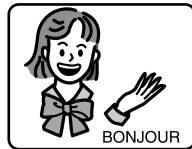

SUBTITLE 2



3

The subtitle display will disappear after about 5 seconds.

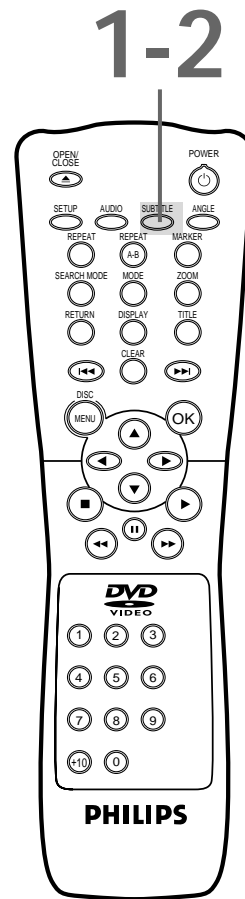

Helpful Hints

- With some DVDs, you may select a subtitle language only in the Disc menu.
- If the desired language does not appear after pressing the SUBTITLE button several times, the Disc does not have subtitles in that language.
- The subtitles may be delayed for a few seconds.
- Opening the disc tray or turning off the Player's power will cancel your subtitle setting. The default setting of the DVD will be active again.
- When "Subtitle Not Available" appears on the TV screen, no subtitle is available for the current scene.

34 Camera Angles

DVD

Some DVDs contain scenes that were recorded from different angles. You may select a camera angle with the DVD Player during playback.

1

Press the **ANGLE** button during playback so that the **Angle display** appears in the top left corner of the TV screen.

2

Within 5 seconds, press the **ANGLE** button repeatedly to select a different angle. The number of available angles appears at the right of the Angle display. In this example, eight angles are available (/8).

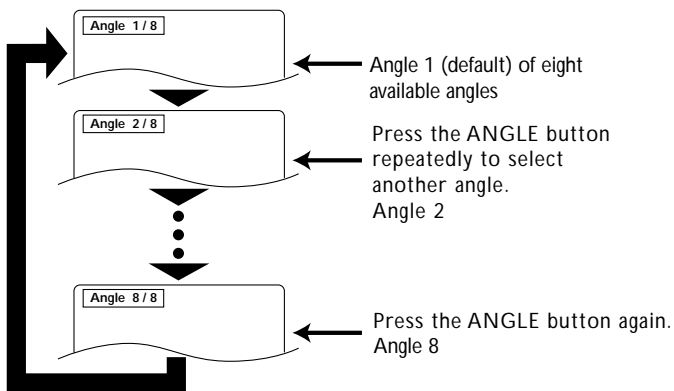

- If the Disc contains sequences recorded from different camera angles, the angle symbol  will appear at the top right corner of the screen. You can change the camera angle when the symbol appears on the screen.
- The camera angle will not change if the Disc does not contain sequences recorded from different camera angles.

1-2

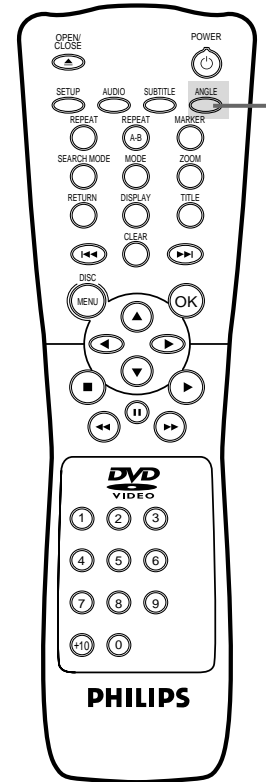

Helpful Hint

- Angle Icon must be On in order for the angle symbol to appear as described in step 2. To set Angle Icon to On, see pages 42-43.

Follow these steps to change your Parental Controls password.

1

While playback is stopped, press the **SETUP** button. The setup screen will appear.

2

Press the Arrow **▲▼** buttons to select **Parental**. Then, press the **OK** button. The Setup/Parental Password menu will appear.

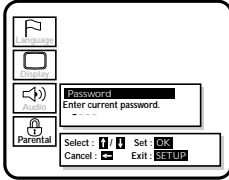

3

Press the **Number** buttons to enter the 4-digit password. The Parental Controls screen will appear. When doing this for the first time, enter any 4 digits. That number will be the password until you change it.

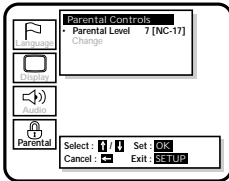

4

Press the Arrow **▲▼** buttons to select **CHANGE**. Then, press the **OK** button.

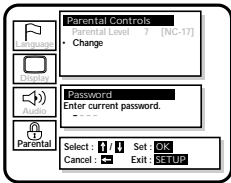

5

Press the **Number** buttons to enter your old password.

6

Press the **Number** buttons to enter a new 4-digit password as prompted on the screen. The Parental Controls screen will reappear, with Parental Level selected.

7

Press the **SETUP** button to remove the menu.

1,7 2,4

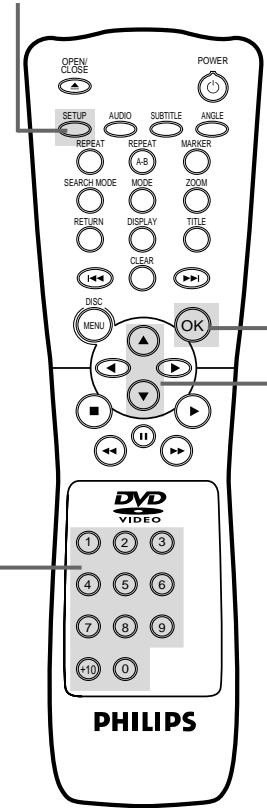

3,5,6

Helpful Hints

- Write down the password in case you forget it.
- If you forget the password, you can reset all of the Player's settings to the factory presets. Remove the Disc from the Player. Press the Number buttons 1,2,3,4, then press the **DISPLAY** button. Then, press the **OK** button. The original settings of the Player will be restored. You need to set the DVD player to your desired setting again.

36 Parental Lock Levels

Follow these steps to set the rating level for your DVD Player. Discs whose ratings exceed the level you set will not play. See Helpful Hints below.

1

While playback is stopped, press the **SETUP** button. The setup screen will appear.

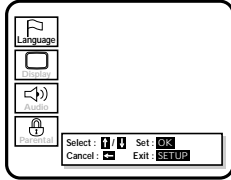

2

Press the **Arrow** \blacktriangle / \blacktriangledown buttons to select **Parental**. Then, press the **OK** button. The Setup/Parental Password screen will appear.

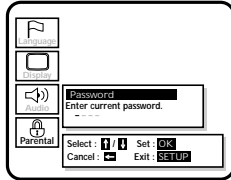

3

Press the **Number** buttons to enter your 4-digit password.

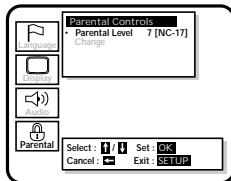

4

Press the **Arrow** \blacktriangle / \blacktriangledown buttons to select **Parental Level**. Then, press the **OK** button.

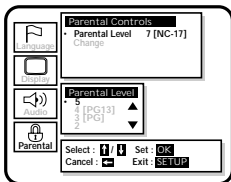

5

Press the **Arrow** \blacktriangle / \blacktriangledown buttons to select the level you desire, then press the **OK** button. For example, if you want to play Discs rated PG13, you must select Level 4 or higher. The level you select will appear on the screen beside **Parental Level**, beneath **Parental Controls** at the top of the screen.

6

Press the **SETUP** button to remove the menu.

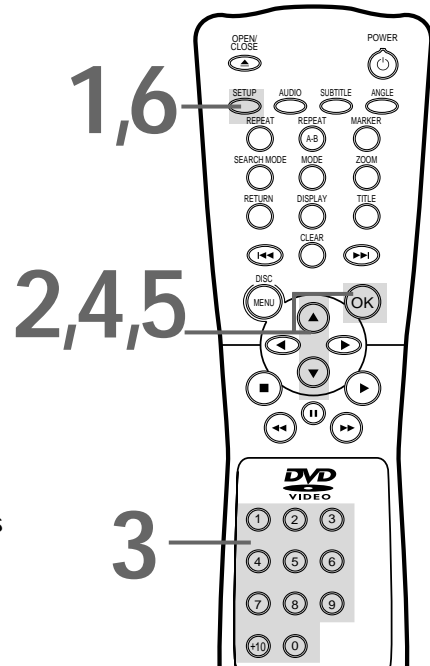

RATING EXPLANATIONS

- NC-17 - Under 17 not admitted
- R - Restricted; under 17 requires accompanying parent or adult guardian
- PG-13 - Unsuitable for children under 13
- PG - Parental Guidance suggested
- G - General Audience

Helpful Hints

- Some DVDs are not compatible with Parental Lock. Make sure the DVD plays according to the Parental Lock settings you have made.
- The DVD Player will not allow you to change Parental Level settings until you enter the correct password.
- When you try to play a Disc that has a rating that exceeds the level you set, a message will appear on the screen, indicating the Disc cannot play. If this happens, eject the Disc, then select a level that allows playback. Or, select All to turn off Parental Lock. Load the Disc again and begin playback as usual. Some Discs may allow you to simply enter your 4-digit password, then begin playback automatically. Follow the instructions of the Disc.

You can check information about the current Disc by pressing the DISPLAY button on the remote control. You can select or change Disc features using the Display Screen.

1

Press the DISPLAY button repeatedly during playback to access or remove the Display Screen.

Example

- Current type of disc
- Playback status
- Repeat status
- Current Title number
- Current Chapter number
- Elapsed playing time of current Title
- Remaining playing time of current Title
- Bit Rate display

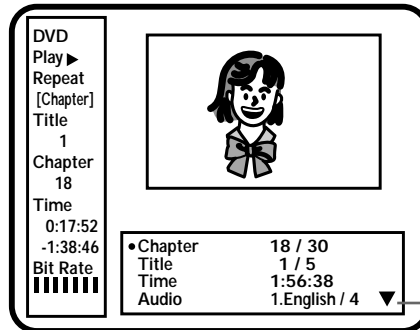

- Current Chapter / Total Chapters in current Title
- Current Title / Total Titles on current Disc
- Total playing time of current Title
- Current settings of Audio, Subtitle, Angle, Marker, and SRS TruSurround

Indicates additional items are available if you press the Arrow button

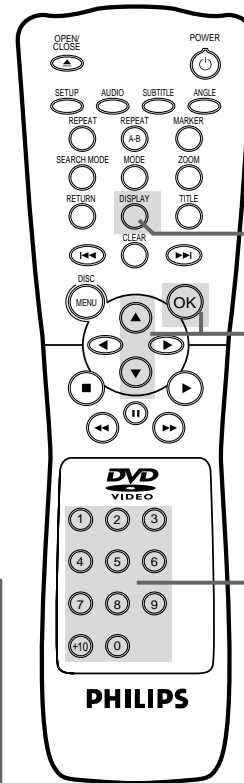

2

To select a new Chapter or Title, use the Arrow ▲▼ buttons to select Chapter or Title, then press the OK button. Use the Number buttons to select the Chapter or Title you want. Playback will begin at the Chapter or Title you selected.

3

To change a setting of Audio, Subtitle, Angle, Marker, or SRS TruSurround, use the Arrow ▲▼ buttons to select an item, then press the OK button.

4

Use the Arrow ▲▼ buttons to select a setting, then press the OK button.

5

Press the DISPLAY button to remove the Display Screen.

This unit employs TruSurround system

TruSurround by SRS of SRS Labs, Inc. as virtual technology.

TruSurround and the  symbol are trademarks of SRS Labs, Inc. TruSurround technology is incorporated under license from SRS Labs, Inc.

Helpful Hints

- If you do not want to change the setting at step 4, press the RETURN button.
- If there are no optional settings for the feature, nothing will happen when you press the OK button to select an item (Angle, Audio, etc.).
- Additional information about the settings is on pages 32-34 and 39-46.

38 Display Screen (Audio CD)

You can check the information about the current Disc by pressing the DISPLAY button on the remote control. You can select or change some Disc features using the Display screen.

1

Press the DISPLAY button repeatedly during playback to access or remove the Display Screen.

- Current type of Disc
- Playback status
- Repeat status
- Current Track number
- Play Mode: Normal, Random, or Program
- [Track] Elapsed playing time of the current Track and Remaining playing time of the current Track
- [All] Elapsed playing time of the current Disc or Program and Remaining playing time of the current Disc or Program

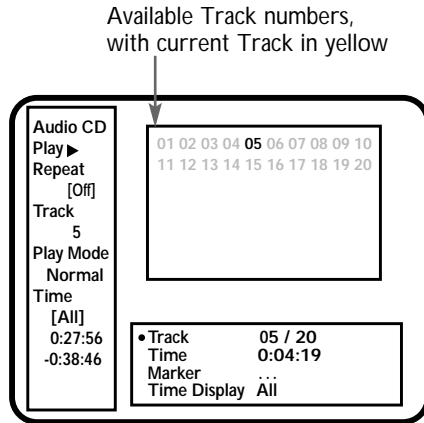

- Current Track / Total Tracks on current Disc
- Total playing time of current Track
- Marker
- Time Display

2

To change a setting, press the Arrow ▲▼ buttons to select an item, then press the OK button.

3

Track: Press the Number buttons of the Track you want to play. Playback will begin at the track you selected.

Time: Press the Number buttons to enter a time within the current Track at which you want playback to begin. For example, if the current Track is three minutes long and you want to begin play one minute and 30 seconds into the song, press 0,0,1,3,0.

Marker: Press the Arrow ▲▼ buttons to select Marker 1, Marker 2, Marker 3, Marker 4, or Marker 5, then press the OK button. Then, press the RETURN button to return to the Display Screen. *Marker details are on page 39.*

Time Display: Press the OK button repeatedly to choose All or Track. This determines whether the times shown in the left box of the Display Screen are for the current Track [Track] or the entire Disc [All].

4

When you are finished, press the DISPLAY button to remove the Display Screen.

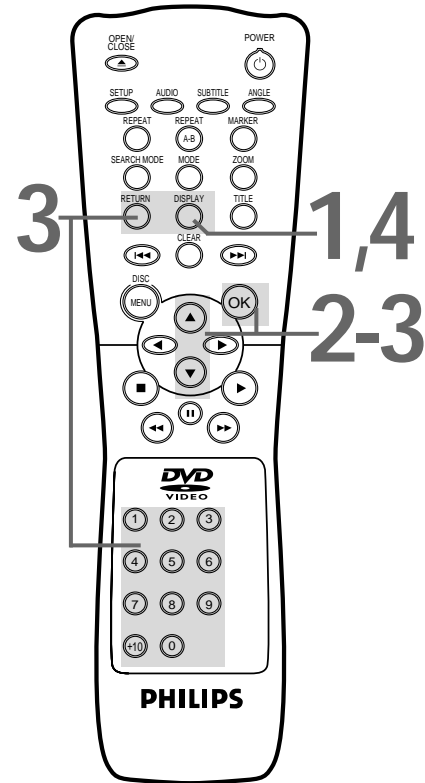

Helpful Hints

- If you select a Track or Time that is not available, playback will continue at its current position.
- During programmed playback, you can not select a Track that is not part of the Program.

Use Markers to remember your favorite places on a disc. You can set Markers on either DVDs or Audio CDs. To set the Markers, follow these steps.

1

During playback, press the **MARKER** button. The Display Screen will appear. (Details are on pages 37-38.) The Markers will appear at the bottom of the screen.

DVD example

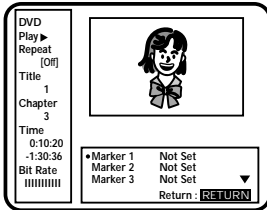

2

Press the Arrow **▲▼** buttons to select Marker 1, Marker 2, Marker 3, Marker 4, or Marker 5. Make sure the Marker you select is "Not Set."

3

Play the Disc to the point at which you want to set the Marker.

4

When the Disc reaches the point that you want to remember, press the **OK** button. The Disc time at the specified point will appear beside the Marker you selected.

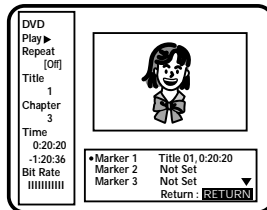

5

Press the **DISPLAY** button to remove the Display Screen.

6

To later return to the point at which you set the Marker, press the **MARKER** button during playback. Press the Arrow **▲▼** buttons to select the Marker you want, then press the **OK** button. Playback will resume at the point you set.

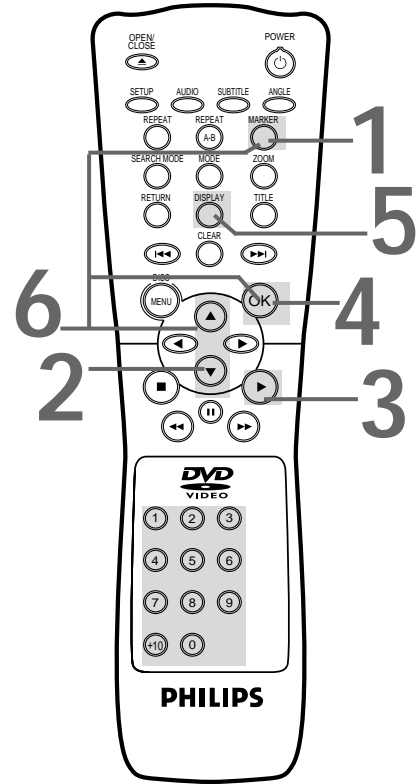

Helpful Hints

- Opening the disc tray or turning off the DVD Player will erase all the Markers.
- To erase a single Marker, press the **MARKER** button, then press the Arrow **▲▼** buttons to select your desired Marker. Press the **CLEAR** button. "Not Set" will appear beside the Marker you cleared. Press the **DISPLAY** button to remove the Display Screen.
- To erase all the Markers, press the **MARKER** button, then press the Arrow **▲▼** buttons to select "Clear All Markers." Press the **OK** button. "Clear All Markers" will appear in the top right corner of the screen. (If no Markers were set, nothing will happen.) Press the **DISPLAY** button to remove the Display Screen.

40 Audio Settings

1

While playback is stopped, press the **SETUP** button. The setup screen will appear.

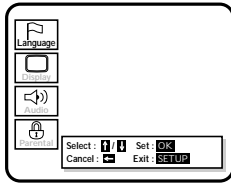

2

Press the Arrow **▲▼** buttons to select **Audio**. Then, press the **OK** button.

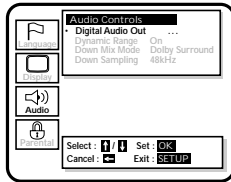

3

Press the Arrow **▲▼** buttons to select an item: **Digital Audio Out**, **Dynamic Range**, **Down Mix Mode** or **Down Sampling**.

4

If you selected **Dynamic Range**, **Down Mix Mode**, or **Down Sampling**, press the **OK** button repeatedly to adjust the setting of these items. When you are finished, go to step 6.

If you selected **Digital Audio Out**, press the **OK** button, then go to step 5.

- **Dynamic Range:** Press the **OK** button repeatedly to turn Dynamic Range On or Off. This compresses the range of sound volume by suppressing loud sound and raising the volume of low sound. However, Dolby Digital 5.1 Channel sound is compressed automatically, even if "Dynamic Range" is "Off."
- **Down Mix Mode:** Press the **OK** button repeatedly to select Stereo or Dolby Surround. Choose Dolby Surround if the DVD Player is connected to audio equipment that is Dolby Surround (Pro Logic) compatible. Choose Stereo if the Player is connected to normal audio equipment.
- **Down Sampling:** Press the **OK** button repeatedly to select 48 kHz or 96 kHz. Select 96 kHz if the Disc was recorded in PCM 96 kHz. Otherwise, select 48 kHz.

Dynamic Range

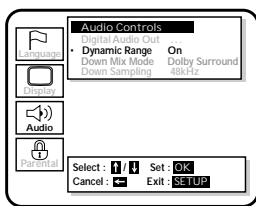

Down Mix Mode

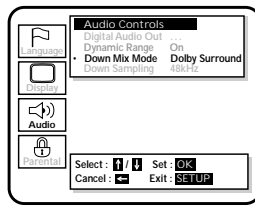

Down Sampling

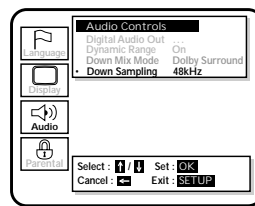

2-4

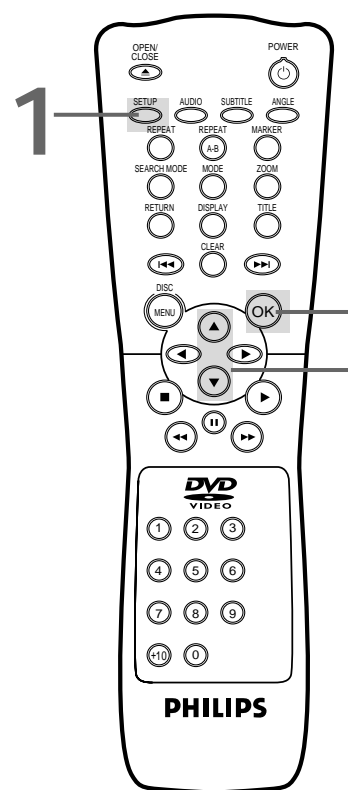

5

When you select Digital Audio Out at steps 3-4, the Dolby Digital, DTS, and MPEG settings will be available at the bottom of the Display Screen. To change the Dolby Digital, DTS, or MPEG settings, press the Arrow ▲▼ buttons to select the desired item, then press the OK button repeatedly to set the item to On or Off.

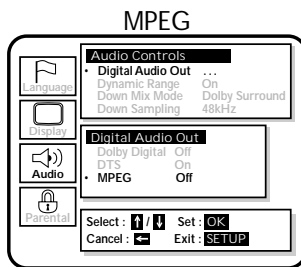
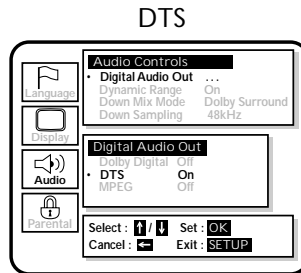
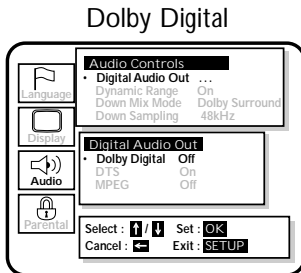

6

Press the SETUP button to remove the menu.

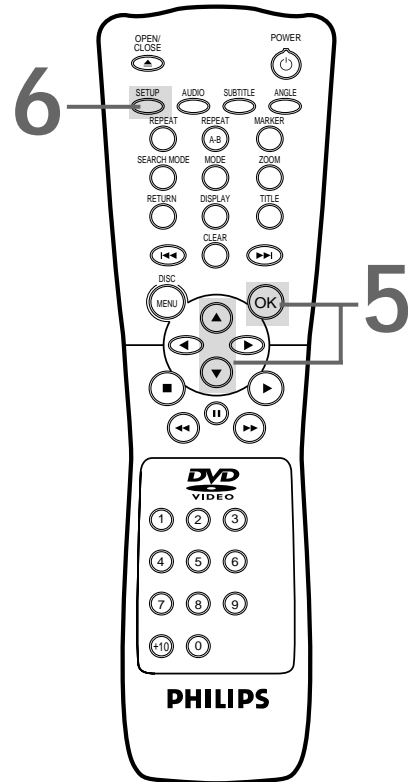

Helpful Hints

- To enjoy Dolby Digital Surround or DTS Surround sound, you must connect the DVD Player to a Dolby Digital or DTS decoder. Details are on page 11.
- MPEG sound is not available if the DVD player is connected to audio equipment that is not MPEG sound compatible.

42 Display Settings

You can change certain aspects of the DVD Player's Display Screens, on-screen messages, and the display panel on the front of the DVD Player. You also can change the TV's Aspect Ratio in the Display menu. To change such settings, follow these steps.

1

When playback is stopped, press the **SETUP** button. The setup screen will appear.

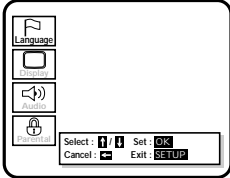

2

Press the Arrow **▲▼** buttons to select **Display**. Then, press the **OK** button.

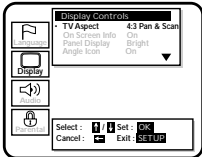

3

Press the Arrow **▲▼** buttons to select an item: **TV Aspect**, **On Screen Info**, **Panel Display**, **Angle Icon**, **Background Color**, or **Auto Power Off**.

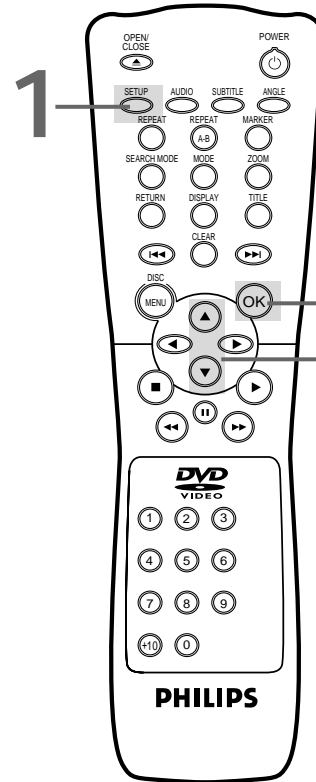

Helpful Hint

- Selecting a different TV Aspect setting will only be effective if it is available on the Disc.

4

If you selected **On Screen Info**, **Angle Icon**, **Background Color**, or **Auto Power Off**, press the **OK** button repeatedly to change the settings of each item.

If you selected **TV Aspect** or **Panel Display**, go to step 5.

- Set **On Screen Info** to **On** if you want to see messages on the TV screen. For example, **Play ▶** will appear in the top right corner of the screen when you press the **Play ▶** button.
- Set **Angle Icon** to **On** if you want to see the **Angle** symbol on the screen. *Details are on page 34.*
- Set **Background Color** to **Blue** or **Gray**. Choose the color you prefer for the background when the menus or messages are on the TV screen.
- Set **Auto Power Off** to **On** if you want the DVD Player to automatically turn off when it is inactive for 35 minutes.

On Screen Info

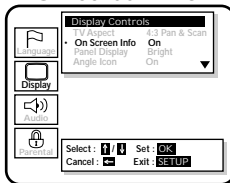

Angle Icon

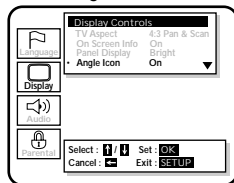

Background Color

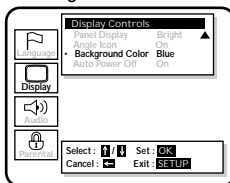

Auto Power Off

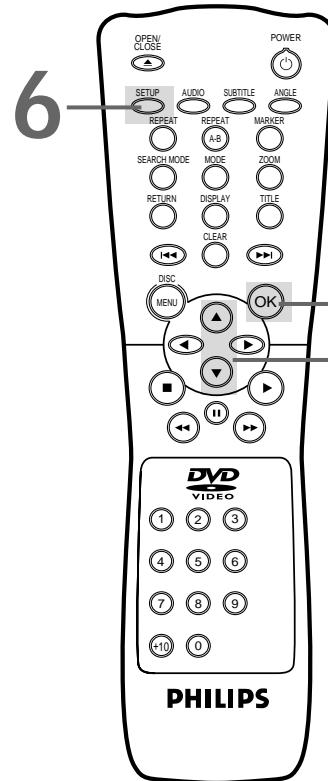
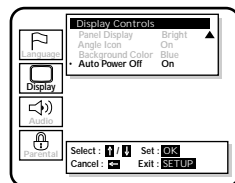

5

Press the **OK** button to select **TV Aspect** or **Panel Display**. Press the **Arrow ▲▼** buttons to select a setting, then press the **OK** button.

- Select **4:3 Pan & Scan** to see the picture in full-height, with one or both sides trimmed.
- Select **4:3 Letterbox** for wide-screen, full-width pictures, with black bars at the top and bottom of the picture.
- Select **16:9 Wide** if you have connected a wide-screen TV to the DVD Player.
- Select **Bright**, **Dim**, or **Auto** to adjust the brightness of the display panel. If you select **Auto**, the display is dim only during playback.

TV Aspect

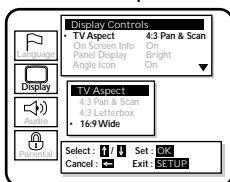

Panel Display

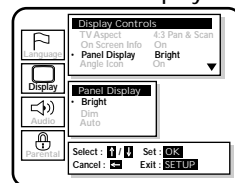

6

Press the **SETUP** button to remove the menu.

4-5

44 Language Settings

DVD

1

While playback is stopped, press the **SETUP** button. The setup screen appears.

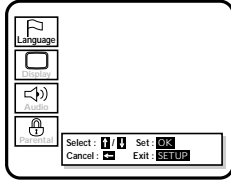

2

Press the Arrow **▲▼** buttons to select **LANGUAGE**. Then, press the **OK** button.

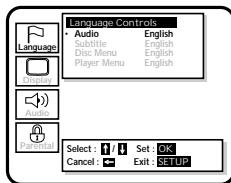

3

Press the Arrow **▲▼** buttons to select an item: **Audio**, **Subtitle**, **Disc Menu**, or **Player Menu**. Then, press the **OK** button.

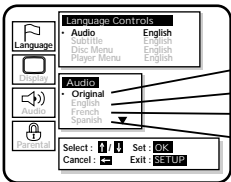

- The voice is in the original language of the disc.
- Voice is in English.
- Voice is in French.
- Voice is in Spanish.

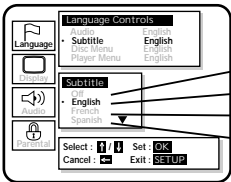

- Subtitles are not shown.
- Subtitles are in English.
- Subtitles are in Spanish.
- Subtitles are in French.

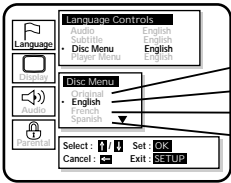

- The disc menu is in the original language of the disc.
- The disc menu appears in English.
- The disc menu appears in French.
- The disc menu appears in Spanish.

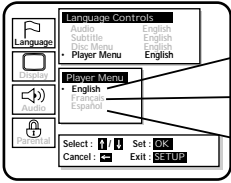

- The displays and DVD Player menus appear in English.
- The displays and DVD Player menus appear in French.
- The displays and DVD Player menus appear in Spanish.

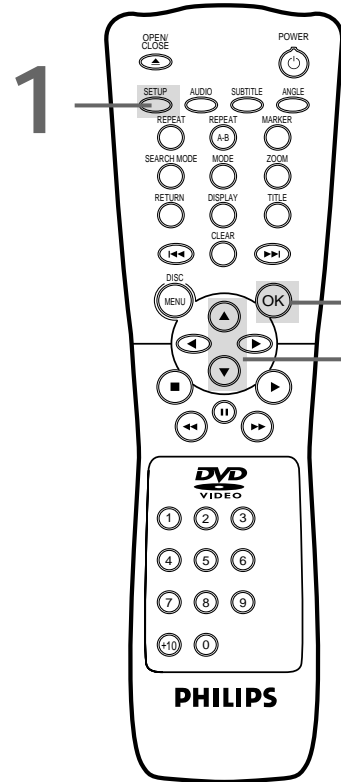

2-3

4

Press the Arrow ▲▼ buttons to select a setting, then press the OK button.

- If you select Other at the Audio, Subtitle, or Disc Menu screen, press four Number buttons to enter the country code you desire. Refer to the list on page 46.
- You can only select other languages for Audio, Subtitle, and Disc Menu if the language is available on the Disc.

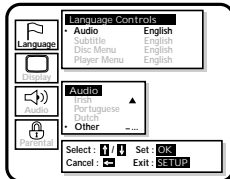

5

Press the SETUP button to remove the menu.

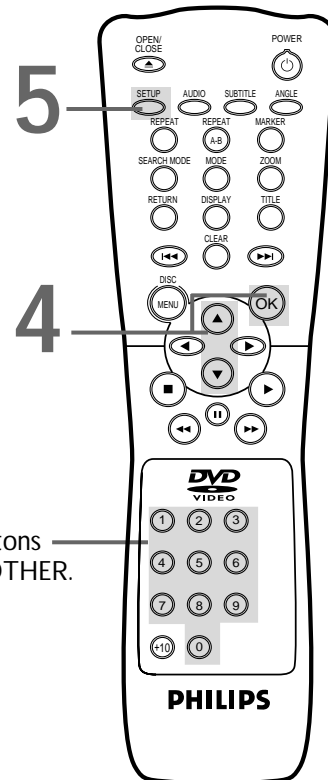

Use these buttons if you select OTHER.

Helpful Hints

- If the automatic settings for Audio and Subtitle are the same language, the subtitles will not be shown.
- Language settings for Audio and Subtitle are not available with some discs. Use the Audio and Subtitle buttons instead to select different languages for the audio and subtitles. Details are on pages 32 and 33.

46 Language Settings (cont'd)

<u>Language</u>	<u>Country Code</u>	<u>Language</u>	<u>Country Code</u>	<u>Language</u>	<u>Country Code</u>
	A-B		I-K		S
Abkhazian	4748	Icelandic	5565	Samoan	6559
Afar	4747	Indonesian	5560	Sangho	6553
Afrikaans	4752	Interlingua	5547	Sanskrit	6457
Albanian	6563	Interlingue	5551	Serbian	6564
Amharic	4759	Inupiak	5557	Serbo-Croatian	6554
Arabic	4764	Irish	5347	Sesotho	6566
Armenian	5471	Italian	5566	Setswana	6660
Assamese	4765	Japanese	5647	Shona	6560
Aymara	4771	Javanese	5669	Sindhi	6550
Azerbaijani	4772	Kannada	5760	Singhalese	6555
Bangla	4860	Kashmiri	5765	Siswat	6565
Bashkir	4847	Kazakh	5757	Slovak	6557
Basque	5167	Kinyarwanda	6469	Slovenian	6558
Bengali	4860	Kirghiz	5771	Somali	6561
Bhutani	5072	Kirundi	6460	Spanish	5165
Bihari	4854	Korean	5761	Sundanese	6567
Bislama	4855	Kurdish	5767	Swahili	6569
Breton	4864		L-N	Swedish	6568
Bulgarian	4853	Laothian	5861		T
Burmese	5971	Latin	5847	Tagalog	6658
Byelorussian	4851	Latvian	5868	Tajik	6653
	C-E	Lettish	5868	Tamil	6647
Cambodian	5759	Lingala	5860	Tatar	6666
Catalan	4947	Lithuanian	5866	Telugu	6652
Chinese	7254	Macedonian	5957	Thai	6654
Corsican	4961	Malagasy	5953	Tibetan	4861
Croatian	5464	Malay	5965	Tigrinya	6655
Czech	4965	Malayalam	5958	Tonga	6661
Danish	5047	Maltese	5966	Tsonga	6665
Dutch	6058	Maori	5955	Turkish	6664
English	5160	Marathi	5964	Turkmen	6657
Esperanto	5161	Moldavian	5961	Twi	6669
Estonian	5166	Mongolian	5960		U-Z
	F-H	Nauru	6047	Ukrainian	6757
Faroese	5261	Nepali	6051	Urdu	6764
Fiji	5256	Norwegian	6061	Uzbek	6772
Finnish	5255		O-R	Vietnamese	6855
French	5264	Occitan	6149	Volapuk	6961
Frisian	5271	Oriya	6164	Welsh	4971
Gaelic (Scots)	5350	Oromo (Afan)	6159	Wolof	6961
Galician	5358	Panjabi	6247	Xhosa	7054
Georgian	5747	Pashto	6265	Yiddish	5655
German	5051	Persian	5247	Yoruba	7161
Greek	5158	Polish	6258	Zulu	7267
Greenlandic	5758	Portugese	6266		
Guarani	5360	Pushto	6265		
Gujarati	5367	Quechua	6367		
Hausa	5447	Rhaeto-Romance	6459		
Hebrew	5569	Romanian	6461		
Hindi	5455	Russian	6467		
Hungarian	5467				

Cleaning the DVD Player

- Wipe the front panel and other exterior surfaces of the DVD Player with a soft, slightly damp cloth.
- Never use a solvent, thinner, benzene or alcohol to clean the DVD Player. Do not spray insecticide liquid near the DVD Player. Such chemicals may discolor the surface or damage the DVD Player.

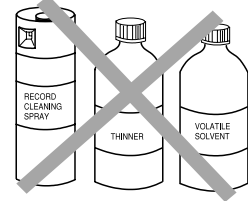

Don't use cleaners.

Cleaning a Disc

- Use a soft, dry cloth to wipe the Disc.
- Wipe the Disc in a straight line from the center to the edge. Never wipe the Disc in a circular motion.
- Do not use detergent or abrasive cleaning agents.
- Handle the Discs so that fingerprints and dust do not adhere to the surfaces of the Discs.
- Always store the Disc in its protective case when it is not in use.

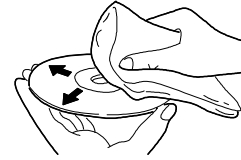

Wipe Discs from the center to the edge.

Checking the Laser

- If the DVD Player does not operate as described in this owner's manual, the laser may be dirty. Consult an Authorized Service Center for inspection and cleaning of the laser.

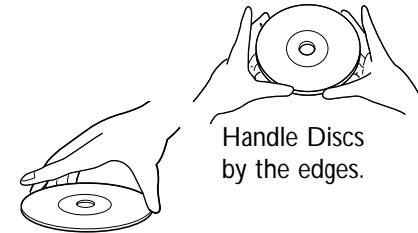

Handle Discs by the edges.

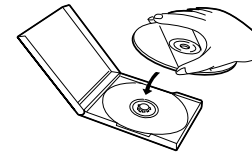

Keep the Disc in its case.

48 Helpful Hints

If you are having problems with your product, check this list of problems and possible solutions before requesting service. You may be able to solve the problem yourself.

If you need to call a customer service representative, please know the model number and serial number of your product before you call. This information is on the back of the product. Also, please take a moment to identify the problem you are having, and be prepared to explain this to the representative. If you believe the representative will need to help you with operations, please stay near the product. Our representatives will be happy to assist you.

The DVD Player has no power.

- Make sure the power cord is connected completely to an AC (alternating current) outlet.
- Press the POWER button to turn on the DVD Player. "P-ON" will appear briefly on the display panel as the power is turning on.

The remote control will not operate the DVD Player.

- Aim the remote control directly at the DVD Player's remote sensor. *Details are on page 14.*
- Remove all obstacles between the remote control and the DVD Player.
- Inspect and/or replace the batteries in the remote control. *Details are on page seven.*
- Use the remote control within 23 feet of the DVD Player.

No picture

- Make sure the video cable is connected correctly. You may connect either the yellow video cable (supplied) or an optional S-Video cable. *Details are on pages 8-12.*
- Make sure the TV is set to the correct Video or S-Video In channel (usually the AUX IN, A/V IN, Auxiliary In, or S-Video In channel). Check your TV owner's manual for details.
- Insert a Disc that is playable on this DVD Player. *Details are on page six.*

Disc cannot play.

- Insert a playable Disc. *Details are on page six.*
- Place the Disc correctly in the recesses in the Disc tray. If the Disc is one-sided, place the Disc in the tray with the label facing up. If the Disc is two-sided, make sure the side you want to play is facing up.
- Clean the Disc.
- Cancel the parental lock, enter the password, or change the control level. *Details are on pages 35-36.*
- Make sure the Disc is labeled for use in Region 1 or ALL regions. *Details are on page six.*

No sound

- Connect the audio cables firmly. Make sure the cables are connected to the AUDIO IN jacks on the TV or audio equipment. *Details are on pages 8-12.*
- Check the audio settings of the DVD Player. *Details are on pages 40-41.*
- Turn on the power of the audio equipment and make sure it is set to the correct channel, usually Auxiliary IN. Refer to the owner's manual of the audio equipment for details.
- Check the audio settings of the Disc. For example, you may have selected "soundtrack" playback on a DVD. Only the music of the movie will play, not the characters' dialog; music might not be recorded throughout the entire DVD. *Details are on page 32.*

Distorted picture

- Connect the DVD Player directly to the TV. *Details are on page eight.*
- There are some cases where the picture may be distorted slightly; this is not a malfunction of the DVD Player.

You can not change the camera angle.

- The DVD might not contain segments recorded from different camera angles. See if multiple angles are available. *Details are on page 34.*

You can not change the audio or subtitle language.

- The DVD does not contain audio or subtitles in the desired language. Not all DVDs contain audio or subtitles in multiple languages. See if other languages are available. *Details are on pages 32-33.*

An "X" appears on the TV screen, prohibiting an operation.

- The DVD Player prohibits the current operation or it is not available on the Disc. *Details are on page five.*

The DVD Player turns off after 35 minutes.

- The DVD Player turns off automatically if playback stops for more than 35 minutes and you press no buttons on the remote control or the DVD Player. *Details are on pages 42-43.*

A screen saver appears on the TV screen.

- The DVD logo will appear on the TV screen if you stop Disc playback for more than five minutes (and you do not press any buttons on the remote control or the DVD Player). The DVD logo prevents damage to your TV's picture tube. A prolonged still image, including TV station identification logos or video games, may damage the picture tube.

50 Specifications

Product Type

Digital Video Disc Player

Playable Discs

DVD-Video

Audio CD

Color System

NTSC

Frequency Response

DVD (linear sound): 20 Hz to 22 kHz (sample rate: 48 kHz)

20 Hz to 44 kHz (sample rate: 96 kHz)

Audio CD: 20 Hz to 20 kHz

Signal-to-Noise Ratio (S/N Ratio)

Audio CD: 110 dB EIAJ (Electronic Industries Association of Japan)

Dynamic Range

DVD (linear sound): 95 dB

Audio CD: 94 dB (EIAJ)

Total Distortion Factor

Audio CD: 0.007% (EIAJ)

Wow and Flutter

Below the measurement limitation ($\pm 0.001\%$ W PEAK) (EIAJ)

Power Requirement

120V AC $\pm 10\%$, 60 Hz $\pm 0.5\%$

Connections

S-Video output	Mini DIN 4-pin jack (75 Ω)
Video output	One pin jack, 1 Vpp (75 Ω)
Coaxial digital output	One pin jack, 500m Vpp (75 Ω)
Analog audio output	Two pin jacks (one left channel, one right channel) 2 Vrms (47 k Ω)

Power Consumption

Power on: 17 W

Standby (power off): 5 W

Operating Temperature

41°F (5°C) to 104°F (40°C)

Relative Humidity

30% to 80%

Dimensions

17-1/8" (W) x 3-3/8" (H) x 8-5/16" (D)

(435mm x 85mm x 211mm)

Weight

5.07 lbs. (2.3 kg.)

NOTE: Designs and specifications are subject to change without notice.

AUDIO OUT Jacks: Jacks on the back of the DVD Player that send audio to another system (TV, decoder, or amplifier).

CD: Compact Disc (audio)

Coaxial jack: Sends digital audio to a decoder or amplifier, allowing you to adjust the volume at the decoder or amplifier. The decoder or amplifier must have a coaxial in jack. This connection provides the 5.1 channel surround sound as heard in movie theaters.

Dolby Digital: A surround sound system that provides 5.1 channel sound as used in movie theaters.

DTS: Digital Theater Systems. This is a surround sound system, but it is different from Dolby Digital. The formats were developed by different companies.

DVD: Digital Video Disc.

Letterbox: A TV aspect ratio setting (4:3). Displays the video in full-width, with black bars at the top and bottom of the TV screen. This format is used often when you see a movie in a theater. If the Disc does not include a letterbox format, selecting Letterbox may have no effect. (For example, some DVD discs are two-sided, with one side playing in Letterbox and the other side playing in a normal format.)

Pan & Scan: A TV aspect ratio setting (4:3). Displays the video with full-height picture, with one or both sides of the picture trimmed.

Remote Control: The small electronic unit that came with your DVD Player; allows you to operate your DVD Player from a distance.

S-Video: Produces a clearer picture by sending separate signals for the luminance and the color. If you connect an optional S-Video cable, you will not need to use the supplied yellow video cable. You can use S-Video only if your TV has an S-Video In jack.

VIDEO OUT Jack: Jack on the back of the DVD Player that sends video to a TV.

Wide: A TV aspect ratio setting (16:9). Displays the video appropriately when you connect the DVD Player to a widescreen TV.

52 Limited Warranty

Digital Video Disc Player

90 days Free Exchange / 91 days–One Year Reduced-Cost Exchange

WHO IS COVERED?

You must have proof of the date of purchase to exchange your product. A sales receipt or other document showing the date that you purchased the product is considered such proof.

WHAT IS COVERED?

Warranty coverage begins the day you buy your product. For 90 days thereafter, you may exchange the defective product for a new or renewed product at the store from which it was purchased or through Philips. Either exchange is made at no cost to you.

From 91 days to one year from the date of purchase, you will pay a preset exchange fee to obtain a new or renewed product. Follow the exchange procedures on the next page. This exchange opportunity ends one year after the date of purchase. The replacement product is covered only for the warranty period of the original product. When the warranty on the original product expires, the warranty on all replaced products also expires.

WHAT IS EXCLUDED?

Your warranty does not cover:

- shipping charges to return defective product.
- labor charges for installation or setup of the product, adjustment of customer controls on the product, and installation or repair of antenna systems outside of the product.
- product repair and/or part replacement because of improper installation, abuse, neglect, misuse, accident, unauthorized repair or other cause not within the control of Philips Consumer Electronics.
- a product that requires modification or adaptation to enable it to operate in any country other than the country for which it was designed, manufactured, approved and/or authorized, or repair of products damaged by these modifications.
- incidental or consequential damages resulting from the product. (Some states do not allow the exclusion of incidental or consequential damages, so the above exclusion may not apply to you. This includes, but is not limited to, prerecorded material, whether copyrighted or not copyrighted.)
- a product that is used for commercial or institutional purposes (including but not limited to rental purposes).

WHERE IS EXCHANGE AVAILABLE?

Warranty exchange is available in all countries where the product is officially distributed by Philips Consumer Electronics. In countries where Philips Consumer Electronics does not distribute the product, the local Philips service organization will attempt to exchange the product, although there may be a delay if the appropriate product is not readily available.

MAKE SURE YOU KEEP...

Please keep your sales receipt or other document

showing proof of date of purchase. Attach it to the owner's manual and keep both nearby. Also keep the original box and packing material in case you need to return your product.

BEFORE EXCHANGING THE PRODUCT...

Please check your owner's manual before exchanging the product. Adjustments of the controls discussed there may save you time and money.

LIMITATION OF LIABILITY AND REMEDY...

Philips is not liable under any circumstances for any direct, indirect, special, incidental, or consequential damages, howsoever incurred, even if notified of the possibility of such damages.

To the extent permitted by local law, the remedies provided in this warranty statement are your sole and exclusive remedy.

This limited warranty gives you specific legal rights, and you may also have other rights which vary from state/province to state/province.

TO EXCHANGE YOUR PRODUCT IN THE U.S.A., PUERTO RICO, OR U.S. VIRGIN ISLANDS...

Follow the instructions stated previously in the "What is Covered" section, or refer to the exchange instructions on the next page.

In the U.S.A., Puerto Rico, and U.S. Virgin Islands, all implied warranties, including the implied warranties of non-infringement, merchantability and fitness for a particular purpose, are specifically disclaimed, and to the extent inconsistent with law of the locality of the user, limited in duration to the duration of this express warranty. Because some states do not allow limitations on how long an implied warranty may last, this limitation may not apply to you.

TO EXCHANGE A PRODUCT IN CANADA...

Please contact Philips at:

1-800-661-6162 (French Speaking)

1-800-363-7278 (English Speaking)

In Canada, this warranty is given in lieu of all other warranties. There are no other warranties, express or implied, including any implied warranties of merchantability or fitness for a particular purpose.

TO GET OUT-OF-WARRANTY EXCHANGE...

In the U.S.A., Puerto Rico, or U.S. Virgin Islands, contact Philips Service Solutions Group at 1-800-531-0039 to obtain the cost of out-of-warranty exchange.

REMEMBER...

Please record below the model and serial numbers found on the product. Also, please fill out and mail your warranty registration card promptly. It will be easier for us to notify you if necessary.

MODEL # _____

SERIAL # _____

Philips Service Solutions Group, P.O. Box 2976, Longview, Texas 75606, (903) 242-4800

EL6478E001 /2-01

EXCHANGE INSTRUCTIONS

If your product is defective, you may be able to exchange it at the store from which it was purchased. Most stores display a Return Policy. If not, ask the manager or sales associate how many days you have to exchange a product with them. After the store's return period has expired, or if the store does not have an exchange program, you may exchange the product with Philips if you have your original sales receipt.

To exchange your product with Philips (per the warranty conditions stated previously), remember:

- If you exchange the product within 90 days of the original purchase, there is no cost to you.
• If you exchange the product more than 90 days after but less than one year after the day of original purchase, contact Philips Service Solutions Group (PSSG) at 1-800-531-0039 to determine the preset cost for exchange.
• After 12 months from the day of original purchase, contact PSSG at 1-800-531-0039 for information regarding out-of-warranty exchange.
• If you do not have your original sales receipt, or if you have any questions, call PSSG at 1-800-531-0039.

To obtain a replacement product from Philips:

- 1. Contact PSSG at 1-800-531-0039 to determine the cost for exchange.
2. Complete the Exchange Form below.
3. Pack the product and its accessories in the original box or a suitable alternative. You will receive replacement accessories with your replacement product. For packing details, call 1-800-531-0039.
4. Put the completed Exchange Form, a copy of the original sales receipt, and the proper payment amount into an envelope. DO NOT SEND CASH. Do not staple or clip these items together. Label the envelope "Return Documents Enclosed." Place this envelope in the box with the product.
5. Seal the box with packing tape and return the product via United Parcel Service (UPS), insured and freight prepaid, to:

Philips Recovery Center
Rojas 6
12420 Mercantile Avenue
El Paso, TX 79928
ATTENTION: DVD PLAYER EXCHANGE

A replacement will be sent to you via UPS within 48 business hours of Philips' receipt of the product.

EXCHANGE FORM

Your Address (street address to which replacement should be delivered, no P.O. boxes allowed):

Name:
Street Address: Apt. #:
City: State/Province: Zip Code/Postal Code:
Phone (day): Phone (night):

Exchange Fee: _____ + Sales Tax: _____ = Total: _____

Method of Payment: (Check one. Please, no cash or CODs.)

_____ Check/Money order Check/Money order No. _____
Account number Expiration date
_____ American Express _____
_____ Visa _____
_____ Novus/Discover _____
_____ Mastercard _____

Signature: _____

Detailed reason for return, use additional paper if necessary: _____

Model Number _____ Serial Number _____

Remember, the return box should include the following:

- The product, • Accessories supplied with the product, and
• Completed Exchange Form and sales receipt, • Payment, if applicable.

54 Index

- ac power cord15
- accessories.....56
- angle button17, 34
- arrow buttons.....16
- audio button.....16, 32
- audio cd6, 18
- audio out jacks.....8-10, 15
- audio setting.....40-41
- a-b repeat.....29
- a-b repeat button.....17, 29

- batteries.....7
- bit rate.....37

- camera angle34
- chapters6, 26
- clear button.....17
- coaxial jack11-12, 15
- connections8-12
- contents, table of4
- controls, remote.....16-17

- disc menu button.....16
- display button17, 37-38
- display panel13
- display screens.....37-38
- dvd video.....6

- fast forward button17, 22
- front panel14

- glossary.....51

- helpful hints48-49
- hookups
 - amplifier with digital in jacks/
md deck/dat deck12
 - dolby digital decoder/
dts decoder11
 - dolby surround
compatible amplifier.....11
 - s-video9
 - stereo10
 - tv8-12

- language.....32-33

- marker button17, 39
- markers39
- menus.....5, 19
- mode button17, 30-31

- next button.....14, 22
- number buttons.....16

- ok button.....16
- open/close button.....14, 16, 18

- parental lock35-36
- password.....35
- pause button14, 17, 20, 21, 23
- play button.....14, 16, 18
- playing.....18
- power
 - button.....16
 - cord.....15
- prev(ious) button.....14, 22
- program.....30

- random31
- rear panel.....15
- remote control
 - buttons16-17
 - sensor14
 - using7
- repeat button.....16, 28
- repeat playback.....28
- resuming play.....20
- return button.....16
- reverse button.....16, 22

- safety precautions3
- setup button.....35-36, 40-46
- search mode button.....16, 25-27
- setting
 - audio40-41
 - language.....32-33, 44-46
- skip buttons.....16, 25
- slow motion23
- sound mode32
- standby-on button14
- still picture.....20
- stop button.....14, 16
- subtitle button17, 33
- s-video out jack9, 15

- table of contents4
- titles6, 19, 26
- title button.....17, 19
- tracks.....6, 25

- video out jack.....8, 11-12, 15

- warranty.....52-53

- zoom button17, 24

SUPPLIED ACCESSORIES

*The following items are supplied with your DVD Player;
they are provided to help you use or set up your DVD Player.*

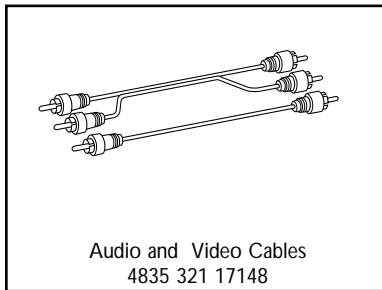
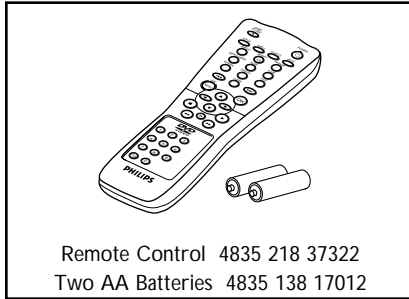

This owner's manual is made of recyclable materials.
Remember to recycle!

IB8319E001
Printed In China
OVMN02837 / E5526UD * * * * *