

DVDVideo Player



*Let's make things better.*



**PHILIPS**

# General Information

The region code for this set is 3.

Since it is usual for DVD movies to be released at different times in different regions of the world, all players have region codes and discs can have an optional region code. If you load a disc of a different region code to your player, you will see the region code notice on the screen. The disc will not playback, and should be unloaded.



*Manufactured under license from Dolby Laboratories. "Dolby", "Pro Logic" and the double-D symbol are trademarks of Dolby Laboratories.*

*This product incorporates copyright protection technology that is protected by method claims of certain U.S. patents and other intellectual property rights owned by Macrovision Corporation and other rights owners. Use of this copyright protection technology must be authorised by Macrovision Corporation, and is intended for home and other limited viewing uses only unless otherwise authorised by Macrovision Corporation. Reverse engineering or disassembly is prohibited.*

*"DTS" and "DTS DIGITAL SURROUND" are registered trademarks of Digital Theater Systems, Inc.*

For Customer Use:

Read carefully the information located at the bottom of your DVD VIDEO player and enter below the Serial No. Retain this information for future reference.

Model No. DVD VIDEO

Serial No. \_\_\_\_\_

## Laser safety

This unit employs a laser. Due to possible eye injury, only a qualified service person should remove the cover or attempt to service this device.

**USE OF CONTROLS OR ADJUSTMENTS OR PERFORMANCE OF PROCEDURES OTHER THAN THOSE SPECIFIED HEREIN MAY RESULT IN HAZARDOUS RADIATION EXPOSURE.**

**NOTE:  
PICTURES SHOWN MAYBE DIFFERENT BETWEEN COUNTRIES.**

### LASER

Type	Semiconductor laser GaAlAs
Wave length	650 nm (DVD) 780 nm (VCD/CD)
Output Power	7 mW (DVD) 10 mW (VCD/CD)
Beam divergence	60 degree

**CAUTION  
(WARNING LOCATION: ON THE BACKPLATE OF SET)**

**NEVER MAKE OR CHANGE CONNECTIONS WITH THE POWER SWITCHED ON.**

English ..... 5

中文(简体)..... 23

中文(繁體)..... 43

Bahasa Melayu ..... 63

English

中文(简体)

中文(繁體)

Bahasa Melayu

# Contents

---

## Introduction

Environmental Information .....	5
Supplied accessories .....	5
Safety Information .....	5
Symbols Used in this Manual .....	5
Before Getting Started .....	6

---

## Functional Overview

Front and Rear Panels .....	7
Remote Control .....	8
Remote Control (Speaker & Karaoke) .....	9
Side Panel (Karaoke) .....	9

---

## Preparation

Basic Connections .....	9
Connecting to a TV .....	10
Connecting to an Audio System .....	10
Connecting to Philips Speaker System .....	10
Connecting to Optional Equipment .....	11
Connecting to a Multi-channel Audio/(Video) receiver with 6 connectors .....	11
Inserting batteries into the Remote Control ..	12
NTSC/PAL Conversion .....	12
Switching On .....	12

---

## Operation

Basic Playback .....	13
General Features .....	13-15
Video Control during playback .....	13
Audio Control during playback .....	13
Repeat .....	13-14
Repeat A-B .....	14
Search .....	14
Display .....	14
Title .....	14
Disc Menu .....	14
Zoom .....	14
Program FTS .....	15
Special DVD Features .....	15
Camera Angle .....	15
Changing the audio language .....	15
Subtitles .....	15
Special VCD & SVCD Features .....	15
Playback Control (PBC) .....	15
Preview .....	15
Karaoke .....	15

---

## Setup Menu

Basic Operations .....	16
General Setup .....	16-17
TV Display .....	16
PIC mode .....	16
Angle Mark .....	17
OSD Lang .....	17
Screen Saver .....	17
Video Out Setup .....	17
Video out .....	17
Channel Setup .....	17
Downmix .....	17
Centre / Rear / Subwoofer .....	17
Cntr Delay / Rear Delay .....	17
Test tone .....	17
Audio Setup .....	18
Audio Out .....	18
Dual mono .....	18
LPCM output .....	18
Dynamic .....	18
Karaoke Setup .....	18
Karaoke mode .....	18
Preferences .....	18-19
TV Type .....	18
Audio / Subtitle / Disc menu .....	19
Parental .....	19
Password .....	19
Default .....	19

---

## JPEG Picture/MP3 Playback

MP3 Discs - Album/Track/Disc .....	20
JPEG Features .....	20
Zoom .....	20
Multi-angles .....	20
Preview .....	20

---

## Specifications

Specifications .....	21
----------------------	----

---

## Maintenance

Maintenance .....	21
-------------------	----

---

## Troubleshooting

Troubleshooting .....	22
-----------------------	----

Thank you for purchasing this Philips DVD player. This Owner's Manual explains the basic operation of this DVD player.

## Environmental Information

All unnecessary packaging has been omitted. Packaging has been made easy to separate into three materials: cardboard (box), polystyrene foam (buffer) and polyethylene (bags, protective foam sheet).

Your DVD player consists of materials which can be recycled and reused if disassembled by a specialised company. Please observe the local regulations regarding the disposal of packaging materials, exhausted batteries and old equipment.

## Supplied accessories

- Remote control
- Batteries (two AA size) for remote control
- Audio cable
- CVBS cable
- Owner's Manual
- 12 Volt Adaptor
- AC Power Cord



## Safety Information

- Before operating the DVD player, check that the operating voltage indicated on the typeplate (or the voltage indication beside the voltage selector) is identical with the voltage of your local power supply. If not, please consult your dealer.
- Place the DVD player on a flat, hard and stable surface.
- There must be sufficient room in front of the player for the disc tray to be opened.

- In cabinet, allow about 2.5cm (1 inch) of free space all around the player for adequate ventilation.
- Do not expose your player to extreme of temperature or humidity.
- If the DVD player is brought directly from a cold to a warm location, or is placed in a very damp room, moisture may condense on the lens of the disc unit inside the DVD player. Should this occur, the DVD player would not operate normally. Leave the power on for about one hour with no disc in the DVD player until normal playback is possible.
- The mechanical parts of the set contain self-lubricating bearings and must not be oiled or lubricated.
- **When the DVD player is switched to Standby mode, it is still consuming some power. To disconnect the system from the power supply completely, remove the AC power plug from the wall socket.**

## Symbols Used in this Manual

The below symbols appear in some headings and notes with the following meanings:

	– Description refers to playback of DVD-video discs
	– Description refers to playback of Video CDs
	– Description refers to playback of Audio CDs

### Helpful Hints!

- **Some DVD video discs require specific functions or allow only limited functions during playback.**

- “” **may appears on the TV screen which means that the function is not available on that specific DVD video disc.**

# Introduction

## Before Getting Started

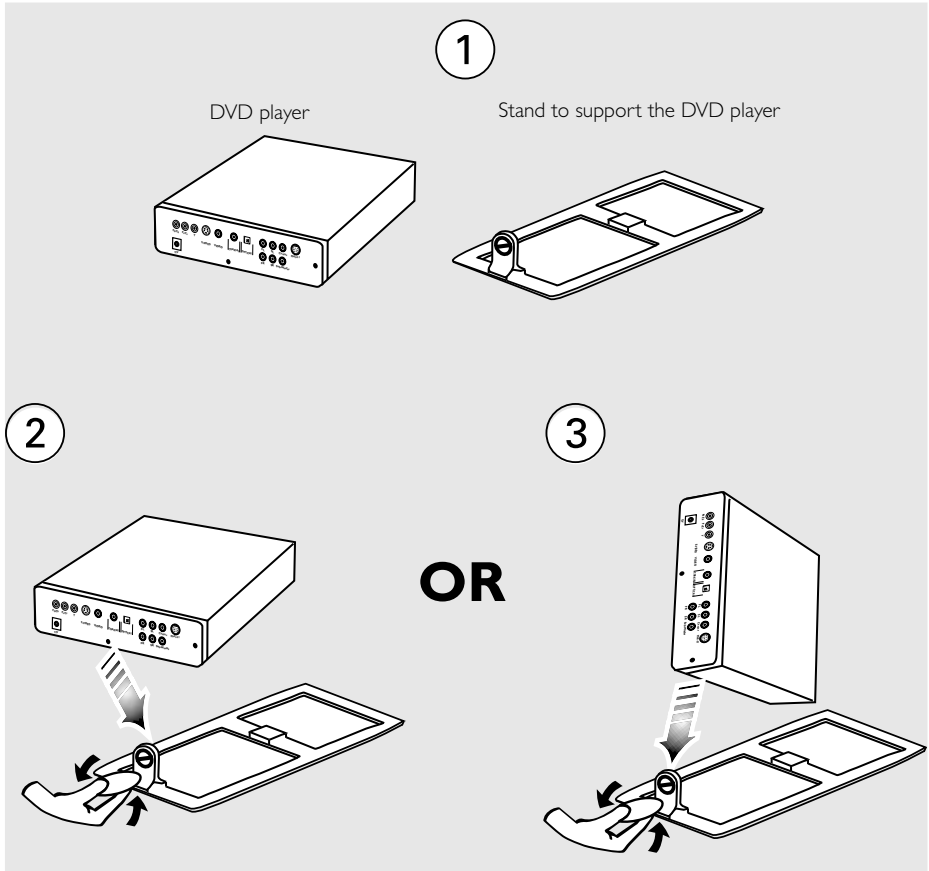

You can place your DVD player in two positions as the following:

### Horizontal Position

- 1 Place the DVD player on the DVD stand in horizontal position.
- 2 Use a coin and adjust the screw to the DVD player rear panel to lock the horizontal position.

### Vertical Position

- 1 Place the DVD player on the DVD stand in vertical position.
- 2 Use a coin and adjust the screw to the DVD player rear panel to lock the vertical position.

## Front and Rear Panels

### STANDBY

- light appears when power is in Standby mode

### Disc Tray

- insert a disc here

### Display

- message about current DVD player operations

### IR Sensor

- receive signals from remote control

### ■ STOP

- to stop playback

### ◀◀ PREV

- goes to previous chapter or track

### ▶▶ NEXT

- goes to next chapter or track

### POWER

- press to turn the power on or off

### ⏮ PLAY/PAUSE

- to start or interrupt playback

### ▲ EJECT

- to reload or to eject the disc

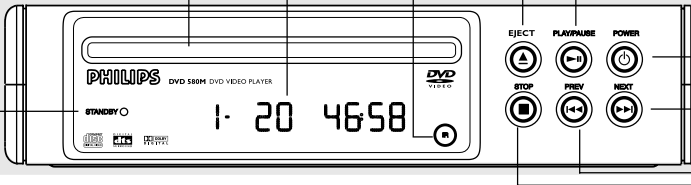

## MULTICHANNEL 5.1 Analogue Audio Out

- connect to SPEAKER inputs of a dedicated speaker system from Philips

## MULTICHANNEL AUDIO OUT

(For connection to a multichannel receiver)

- center speaker, subwoofer, front and surround speakers connection

## OPTICAL (Digital audio out)

- connect to digital (optical) audio equipment

## COAXIAL (Digital audio out)

- connect to AUDIO inputs of a digital (coaxial) audio equipment

## 12Volts DV Input

- connect to an external adaptor

## Pr/Cr Pb/Cb Y VIDEO OUT

- connect to a TV with Pr/Cr Pb/Cb Y inputs

## S-VIDEO OUT

- connect to a TV with S-Video inputs

## VIDEO

- connect to Video inputs of a TV

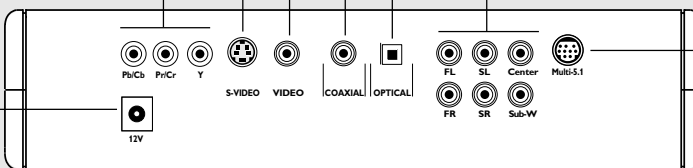

**Caution: Do not touch the inner pins of the jacks on the rear panel. Electrostatic discharge may cause permanent damage to the unit.**

# Functional Overview

## Remote Control

### PBC ON/OFF

- to switch on or off PBC mode

### VIDEO SYS

- to select between MULT/NTSC/PAL system

### DISPLAY

- to display time information during playback

### DVD

- switch DVD ON or go to standby-on mode

### 0 to +10 numerical key pad

- select numbered items in a menu

### ◀ ▶ ▲ ▼

- (left/right/up/down) select an item in the menu

### OK

- acknowledge menu selection

### SLOW REV

- to go backward in slow motion

### PREV (◀)

- go to previous chapter or track

### NEXT (▶)

- go to next chapter or track

### SLOW FWD

- to go forward in slow motion

### SEARCH

- playback at any chosen time on CD or VCD
- playback at any chosen chapter or time on DVD

### PREVIEW

- display the content of a track or whole disc

### SOUND MODE

- to select between left, right and stereo in CD/VCD mode

### SOUND 3D

- to select the desired sound effect

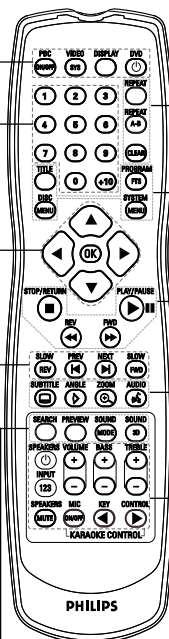

### REPEAT

- repeat chapter, track, title, disc

### REPEAT (A-B)

- repeat a specific segment

### CLEAR

- to delete actions not needed

### TITLE

- display title menu during playback

### DISC MENU

- access menu of a DVD disc

### SYSTEM MENU

- access or remove player's system menu

### PROGRAM FTS

- to store your favourite tracks of a disc in the player memory.

### STOP/RETURN (■)

- go back to previous menu / to stop playback

### REV ◀◀ (REVERSE)

- to go backward in fast motion

### FWD ▶▶ (FORWARD)

- to go forward in fast motion

### PLAY/PAUSE (▶||)

- to start or interrupt playback

### SUBTITLE

- subtitle language selector

### ANGLE

- select DVD camera angle

### ZOOM

- enlarge video image

### AUDIO

- audio language selector

*For Speaker and Karaoke, see next page*



## Remote control (Speaker & Karaoke)



### For Speaker

#### **SPEAKER**

– switch speaker ON or go to standby-on mode

#### **VOLUME** ( ± )

– to increase or decrease the volume

#### **BASS** ( ± )

– to adjust the bass level

#### **TREBLE** ( ± )

– to adjust the treble level

#### **INPUT 123**

– to select speaker input 1, 2, 3

#### **SPEAKERS MUTE**

– to interrupt or resume sound

### For Karaoke Control

#### **MIC ON/OFF**

– to switch ON/OFF microphone

#### **KEY CONTROL** ( ◀ ▶ )

– changing key of vocal range

## Side Panel (Karaoke)

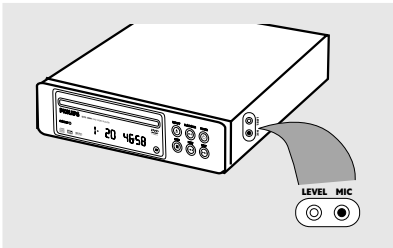

### For Karaoke

#### **LEVEL**

– microphone volume control

#### **MIC**

– for connecting microphone

## Basic Connections

- Please refer to the instruction books of your TV, VCR, Stereo System or other devices as necessary to make the best connections.
- Make one of the following connections, depending on the capabilities of your existing equipment.

The following guidelines are options for the best picture and sound quality available on your DVD player:

### Picture

- 1 Use the CVBS Video Output for good picture quality.
- 2 Use S-Video Output for the better picture quality.
- 3 Use Component Video (Y CbPb CrPr) Output for best picture quality.

### Sound

- 1 Digital audio connections provide the clearest sound. Connect the DVD player's DIGITAL AUDIO OUT (either COAXIAL or OPTICAL) to your amplifier or receiver.
- 2 If digital connections are not possible, connect the DVD player's Front Left and Front Right AUDIO OUT to your amplifier, receiver, stereo or TV.

### Warning!

- Never make or change connections with the power switched on.
- Connect the DVD player directly to your TV, instead of eg. a VCR, to avoid distortion because DVD video discs are copy protected.
- Do not connect the DVD player AUDIO OUT to PHONO IN of your amplifier or receiver.

# Preparation

## Connecting to a TV

- Make one of the following connections, depending on the capabilities of your existing equipment.

### If your TV has a Component Video (Y CbPb CrPr) input connector,

- 1 Connect the Component VIDEO (Y CbPb CrPr) OUT on the DVD player to the Component VIDEO (Y CbPb CrPr) IN on the TV.
- 2 Connect the Front Left and Front Right AUDIO OUT on the DVD player to the Left and Right AUDIO IN on the TV.

### If your TV has a Video input connector,

- 1 Connect the VIDEO OUT on the DVD player to the VIDEO IN on the TV.
- 2 Connect the Front Left and Front Right AUDIO OUT on the DVD player to the Left and Right AUDIO IN on the TV.

### If your TV has a S-Video input connector,

- 1 Connect the S-VIDEO OUT on the DVD player to the S-VIDEO IN on the TV.
- 2 Connect the Front Left and Front Right AUDIO OUT on the DVD player to the Left and Right AUDIO IN on the TV.

## Connecting to an Audio System

- 1 You can also listen to the sound of audio CDs and DVD video discs by connecting to an optional stereo system.
- 2 Connect the Front Left and Front Right on the DVD player to the Left and Right AUDIO IN on the stereo system.

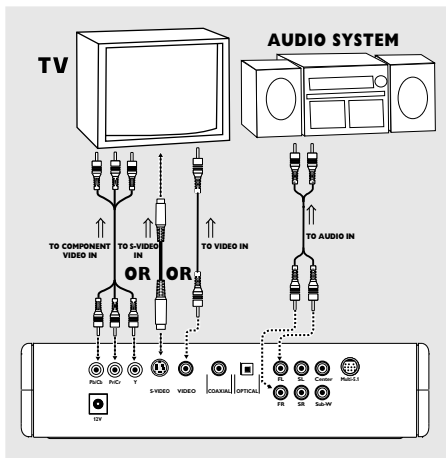

## Connecting to Philips Speaker System

- Connect the MULTI 5.1 channel output on the DVD player to the dedicated Philips Speaker system (cable supplied with the speaker system).

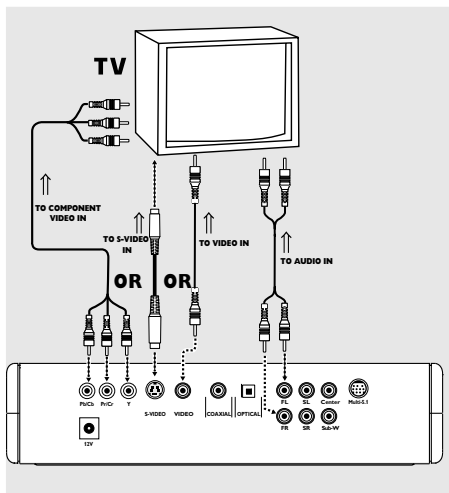
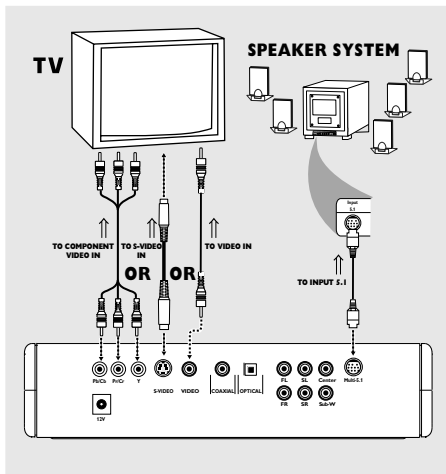

## Connecting to Optional Equipment

- A digital component with a built-in MPEG 2 or Dolby Digital™ decoder allows you to enjoy the surround sound while producing the effect of being in a movie theater or a concert hall.
- The player outputs the surround sound signals from the DIGITAL OUT COAXIAL or OPTICAL connectors.

### If your receiver has a MPEG 2 or Dolby Digital™ decoder,

- 1 Connect the COAXIAL or OPTICAL DIGITAL AUDIO OUT of the DVD player to the COAXIAL or OPTICAL DIGITAL AUDIO IN on your receiver.

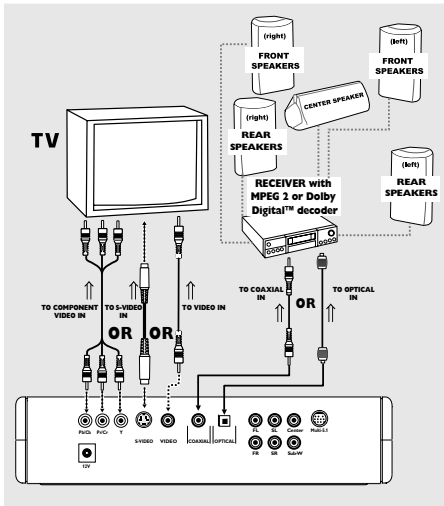

**Note:**

— If the audio format of the digital output does not match the capabilities of your receiver, the receiver will produce a strong, distorted sound or no sound at all.

## Connecting to a Multi-channel Audio/(Video) receiver with 6 connectors

- This player contains a multi-channel decoder and it enables playback of DVDs recorded in Multi-channel.

- 1 Connect the audio Left and Right outputs for Front speaker connection (1) to the corresponding input sockets on your receiver using the audio cable supplied.
- 2 Connect the audio Left and Right outputs for Surround speaker connection (2) to the corresponding inputs on your receiver using an optional audio cable.
- 3 Connect the audio outputs for Center speaker and Subwoofer connection (3) to the corresponding inputs on your receiver using an optional audio cable.
- 4 In the CHANNEL SETUP menu, select DOWNMIX to OFF.
- 5 The 6CH function is now enable (see 'Setup Menu').

**Note:**

— If the subwoofer is equipped with its own amplifier, the Subwoofer connection should be connected directly to the subwoofer.

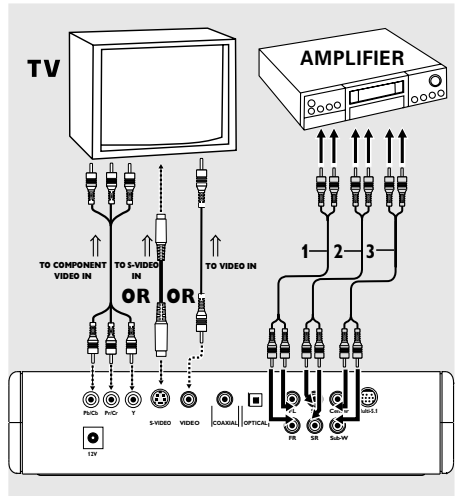

# Preparation

## Inserting batteries into the Remote Control

- 1 Open the battery cover.
- 2 Insert batteries (AA size) with the correct polarity as indicated by the + and - symbols inside the battery compartment.
- 3 Close the cover.

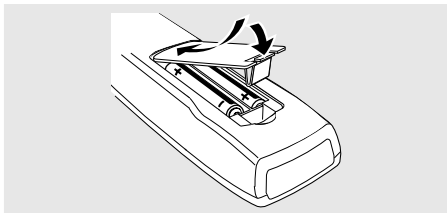

### CAUTION!

- Remove batteries if they are exhausted or not to be used for a long time.
- Do not use old and new or different types of batteries in combination.
- Batteries contain chemical substances, so they should be disposed off properly and kept away from children.

## Using the Remote Control

- Direct the remote control at the remote sensor of the DVD player.
- Do not drop the remote control.
- Do not leave the remote control near extremely hot or humid place.
- Do not spill water or put anything wet on the remote control.

## NTSC/PAL Conversion

- This player is equipped with an NTSC/PAL conversion feature that converts the video output of the disc to match your TV system.
- Allows you to select between PAL, NTSC and MULTI mode.

The conversions supported are as follows:

Disc Type	Format	Output format Selected mode		
		NTSC	PAL	AUTO
DVD	NTSC	NTSC	PAL	NTSC
	PAL	Not Supported	PAL	PAL
VCD	NTSC	NTSC	PAL	NTSC
	PAL	NTSC	PAL	PAL

- 1 Press VIDEO SYS on the remote control to access the preference video standard.

### Notes:

- If you have a PAL only TV, ensure that your PAL/NTSC setting is PAL.
- MULTI can only be selected when using a TV that has both the NTSC and PAL systems.
- This setting is applicable for CVBS output on cinch and SCART only.
- Slight picture distortions may occur due to this conversion. This is normal. Thus, the MULTI format is most suitable for the best picture quality.

## Switching On

- 1 Connect the AC power cord to the power outlet.
- 2 Switch on the TV and DVD player.
- 3 Set the TV to the correct Video IN channel. (eg. EXT1, EXT2, AV1, AV2, AUDIO/VIDEO, etc. (Refer to your TV owner's manual for detail)  
→ The player display lights up and the default screen appears on the TV.
- 4 If you are using an external equipment (eg. audio system or receiver), turn them on and select the appropriate input source that was used to connect to the DVD player output. Refer to the equipment owner's manual for detail.

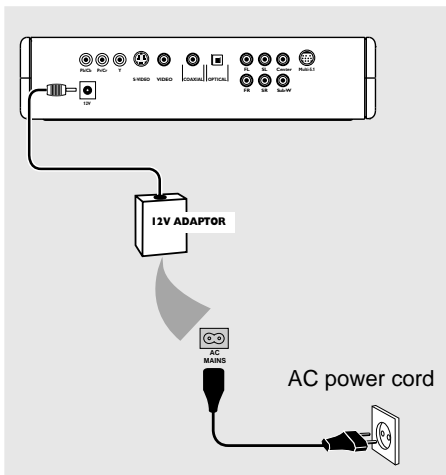

## Basic Playback

- 1 Press POWER on the front panel to turn on the DVD player.
- 2 Insert the chosen disc in the tray, with the label facing up.
- 3 Disc playback starts automatically or press PLAY to start playback depending on the disc menu on the TV screen.
- 4 Press EJECT to eject or reload the disc.

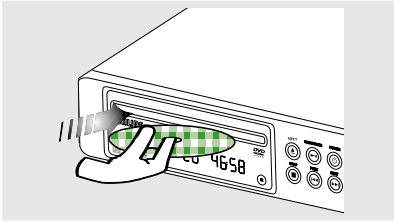

### Notes:

- DVDs may have a region code. Your player will not play discs that have a region code different from the region code of your player.
- If 'Disc Lock' is set to ON and the disc inserted is not authorised, the 4-digit code must be entered and/or the disc must be authorised (see 'Disc Lock').

## General Features

### Note:

- Unless stated, all operations described are based on remote control use. Some operations can be carried out using the menu bar on the TV screen.

## Video Control during playback

**DVD** **YCD** **CD**

### STOP/RETURN

- 1 You can resume playback from the point where the playback was last stopped by pressing the STOP/RETURN key once.
  - The help line text appears "Press PLAY to continue" will be displayed.
- 2 Playback will start from the beginning if you press STOP/RETURN key twice to stop playback.

### PAUSE/PLAY

- 1 Press PAUSE/PLAY once.
  - Playback will pause.
- 2 To resume normal playback, press PAUSE/PLAY again.

### PREV/NEXT

- 1 Press PREV ◀ to go to previous chapter or track.
- 2 Press NEXT ▶ to go to next chapter or track.

### SLOW MOTION

- 1 Press SLOW (FWD) or SLOW (REV) repeatedly to get different playback slow forward/backward speed (1, 2, 3, OFF).
- 2 Press PLAY to return to normal playback.

### Note:

- Slow backward feature is not applicable during VCD playback.

### REV/FWD

- 1 Press REV ◀◀ or FWD ▶▶ repeatedly to get different playback forward/backward speed (1, 2, 3, 4, OFF).

## Audio Control during playback

### SOUND MODE

#### **DVD**

DVD has two stereo audio channels which are used for playing karaoke or the audio language selection.

- 1 Press SOUND MODE repeatedly to get different audio channel.

#### **YCD**

YCD has only one stereo audio channel; mono left audio channel or mono right audio channel by pressing the SOUND MODE key on the remote control.

### SOUND 3D **DVD** **YCD**

The DVD player can reproduce with the maximum of 5 virtual surround sound effects. Sound 3D is available only when set to 'Karaoke mode'.

- 1 Press SOUND 3D repeatedly to switch for different sound effect.

### Repeat

#### **DVD**

#### Repeat chapter/title/disc

- To repeat the current chapter, press REPEAT.
- To repeat the current title, press REPEAT a second time.
- To exit Repeat mode, press REPEAT a third time.

# Operation

## VCD CD

### Repeat track/disc

- To repeat the current track, press REPEAT.
- To repeat the entire disc, press REPEAT a second time.
- To exit Repeat mode, press REPEAT a third time.

## Repeat A-B DVD VCD CD

- **DVD-Video Discs: repeat a sequence in a title**
- **Video and Audio CDs: repeat a sequence in a track**

- 1 Press REPEAT A-B at your chosen starting point.
- 2 Press REPEAT A-B again at your chosen end point.  
→ The playback of the repeat sequence begins.
- 3 To exit the sequence, press REPEAT A-B.

## Search

### DVD

- 1 Press SEARCH key to display chapter edit box.
- 2 Enter the desired chapter number using remote control numerical key pad.
- 3 Press SEARCH second time to enter time selection mode.
- 4 Enter hours, minutes and seconds from left to right in the time edit box using remote control numerical key pad (eg. 00:34:27).
- 5 Press OK key to confirm.

## VCD CD

- 1 Press SEARCH key to display the time edit box.
- 2 Enter minutes and seconds from left to right in the time edit box using remote control numerical key pad (eg. 34:27).

## Display DVD VCD CD

Information about the disc will be display by pressing the DISPLAY button on the remote control during disc playback.

### DVD disc:

TITLE CHAPTER NUMBER / TIME ELAPSED  
TITLE REMAIN  
CHAPTER ELAPSED  
CHAPTER REMAIN

### VCD disc:

When PBC is set to ON; the following options will appears;

**SINGLE ELAPSED**

**SINGLE REMAIN**

**TOTAL ELAPSED**

**TOTAL REMAIN**

**OFF**

When PBC is set to OFF, the following options will appears;

**TOTAL ELAPSED**

**TOTAL REMAIN**

### CD disc:

**SINGLE ELAPSED**

**SINGLE REMAIN**

**TOTAL ELAPSED**

**TOTAL REMAIN**

**OFF**

## Title DVD

- 1 Press TITLE key to display the title menu on the screen.
- 2 Use the ◀▶▲▼ keys to move to the required title and OK to confirm.
- 3 You can also enter the numerical key pad to play the selected title.

## Disc Menu

### DVD

- 1 Press DISC MENU key to display the chapters available on the DVD disc.
- 2 Use the ◀▶▲▼ keys to move to the required title and OK to confirm.
- 3 You can also enter the numerical key pad to play the selected chapter.

## Zoom DVD VCD

The Zoom function allows you to enlarge the video image and to pan through the enlarged image.

- 1 Press ZOOM key on the remote control.
- 2 Select the required zoom factor: 1.5 or 2 or 4 or OFF using ◀▶▲▼ keys to pan across the screen.  
→ The zoomed picture will appear on the TV screen.
- 3 Press ZOOM key again to return to the normal size.

## Program FTS

- 1 While playback is stopped, press PROGRAM FTS on the remote control.  
→ The program FTS edit box appears.
- 2 Enter the desired track using the numerical key pad on the remote control.  
→ The title number will be added to the list of selections.
- 3 Press CLEAR on the remote control to erase the track number which is not needed.
- 4 Press PLAY/PAUSE to begin playback of the programmed track.

**Note:**

- For VCD disc, program FTS will be activated only during PBC OFF.
- Program FTS is not available on DVD/MP3 discs.

## Special DVD Features

DVDs may contain menus to navigate the disc and access special features. Press the appropriate numerical key or use the **▼**, **▲**, **▶**, **◀** keys to highlight your selection in the DVD menu and press OK to confirm.

## Camera Angle

Some discs contain scenes which have been shot simultaneously from various angles.

- Press ANGLE key on the remote control repeatedly to display the multiple angles (4/4, 3/4, 2/4, 1/4).

## Changing the audio language

- 1 Press **AUDIO** key on the remote control repeatedly to select the different languages.

**Note:**

- This feature is subject to availability of the disc.

## Subtitles

- 1 Press the **SUBTITLE** key on the remote control repeatedly to select the different subtitles.

## Special VCD & SVCD Features

### Playback Control (PBC)

- 1 Load a Video CD with PBC and press PLAY.
- 2 Press PBC key to switch to PBC ON or OFF mode.
- 3 Press again the PLAY key to start playback.

**Note:**

- When PBC is ON, playback will start from the beginning of the disc by pressing STOP key.

### Preview

The Preview function allows you to reduce the picture of 9 tracks enough to display in a full screen.

- 1 At stop mode and when PBC is set to OFF, press PREVIEW key on the remote control.  
→ The preview menu will be displayed.
- 2 Select the track number by using the numerical key pad on the remote control.
- 3 Playback will start automatically on the selected track.

### Karaoke

- 1 Load a karaoke disc into the DVD player.
- 2 Select KARAOKE SETUP in the Setup menu.  
→ Karaoke menu bar appears.



- 3 Select to karaoke mode to activate the karaoke function.
- 4 Connect a microphone to the player at the side of the player.
- 5 Adjust the KEY CONTROL ( ± ) to change the key of vocal range.
- 6 Adjust the LEVEL volume knob at the side of the player to increase or decrease the microphone volume.

**Note:**

- 3D options are available in Karaoke mode.

# Setup Menu

## Basic Operations

- 1 Press SYSTEM MENU to enter the Setup menu.  
→ Setup menu appears on the TV screen.
- 2 Use the ◀ ▶ ▲ ▼ keys to toggle through the functions and select your preferred option.
- 3 Press OK to confirm a highlighted selection.
- 4 Press SYSTEM MENU again or move ▼ key to EXIT SETUP MENU on the screen and press OK to quit.

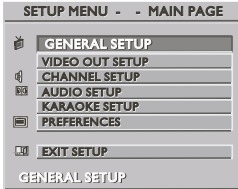

## General Setup Menu

- 1 Press ▲ ▼ keys to choose GENERAL SETUP menu.
- 2 Press OK to confirm a selection.  
→ Setting for GENERAL SETUP appears on the TV screen.
- 3 Select MAIN PAGE to exit to default screen.

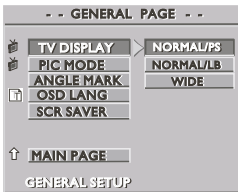

## TV Display

Select the aspect ratio of the TV to be connected.

**16:9 (WIDE)** → when you connect a wide-screen TV to the DVD player:

**4:3 NORMAL/LB** → when you connect a normal TV to the DVD player: Displays a wide picture with bands displayed on the upper and lower portions of the TV screen.

**4:3 NORMAL/PS** → when you connect a normal TV to the DVD player: Displays the wide picture on the whole TV screen with a portion automatically cut off.

16:9



4:3  
Normal LB



4:3  
Normal PS



## PIC mode

In this menu, you can choose one picture mode to personalize the effect of the picture on your TV.

Auto: Images are automatically set to standard settings.

Hi-Res: Images are sharper and clearer to achieve a high quality resolution mode.

N-Flicker: Images are set to flickerless mode.



## Angle Mark

ON: Current angle setting will be display on the right hand side of the screen.  
 OFF: Disable the current angle setting display.

## OSD Lang

There are two options available for information display on the TV screen.  
 ENGLISH: OSD information will be displayed in English.  
 CHINESE: OSD information will be displayed in Chinese.

## Screen Saver

This function is used to turn on or off the screen saver:  
 ON: At stop mode, screen saver will turn on within 2 seconds.  
 OFF: Screen is disable.

## Video Out Setup

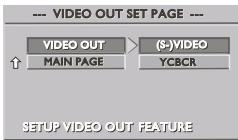

## Video Out

S-Video: Video signal will send an output from the S-Video on the rear panel of the DVD player to the TV.  
 YCbCr: If your TV is equipped with YCbCr input, choose this feature to obtain higher picture quality.

## Channel setup

This menu contains setup options for your speaker system to reproduce high quality surround sound.

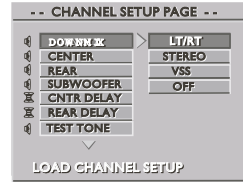

## Downmix

LT/RT: Select this settings when the DVD player is connected to a Dolby Prologic decoder which send a signal output from the DVD player.  
 STEREO: This setting will downmix the signal of Dolby Digital and DTS into stereo signals directly output from front L/R connector.  
 VSS: Allows the DVD player to reproduce virtual surround sound effects.  
 OFF: To disable the DOWNMIX mode.

## Centre / Rear / Subwoofer

Set DOWNMIX mode and Karaoke mode to OFF to enable this settings.  
 ON: Enable signal output for centre/rear/subwoofer speaker.  
 OFF: Disable signal output for centre/rear/subwoofer speaker.

## Cntr Delay / Rear Delay

Set Centre Delay or Rear Delay mode to ON in the menu to delay the sound reproduction from the speakers.

## Test tone

This setting is used to verify the audio system connection. When TEST TONE is ON, some sound can be heard from every speaker.  
 ON: Enable the test tone.  
 OFF: Disable the test tone.

# Setup Menu

## Audio Setup

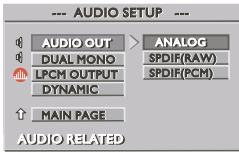

### Audio Out

**Analog:** Analog output selection enables you to specify the type of analog output to match your DVD player's playback capability.  
**SPDIF (RAW):** Original digital signals output from coaxial and optical terminals.  
**SPDIF (PCM):** Convert to PCM signals output.

**Note:**

– When SPDIF (RAW) and SPDIF (PCM) is set, analog output will be disable.

### Dual mono

**Stereo:** Left mono sound will send output signals to Left speaker and Right mono sound will send output signals to Right speaker.  
**L-mono:** Left and Right mono sound will send output signals to Left speaker only.  
**R-mono:** Left and Right mono sound will send output signals to Right speaker only.  
**Mix-mono:** Left and Right mixed mono sound will send output signals to Left and Right speakers.

### LPCM output

To set a sampling rate to decode LPCM audio.  
**LPCM 96k:** Detect the disc for appropriate sampling rate, if the disc is not 96kHz, select LPCM 48k to decode the process under the sampling rate of 48kHz.

### Dynamic

To optimised the dynamic sound output. High volume outputs are softened, enabling you to watch your favourite action movie without disturbing others.  
The levels for dynamic selection:  
1/8, 2/8, 3/8, 4/8, 5/8, 6/8, 7/8, 8/8 and OFF.

## Karaoke Setup



### Karaoke mode

**OFF:** Disable the karaoke mode.  
**Karaoke:** Enable the karaoke mode.

**Note:**

– When Karaoke mode is set to ON, individual speaker in Channel setting manual will not be activated.

## Preferences

Preferences features can be selected only when the player is under "No disc" condition.

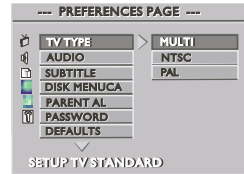

### TV Type

This player is equipped with an NTSC/PAL settings to ensure that the DVD player system matches your TV.  
**MULTI:** video output is depending on the format of the disc.  
**NTSC:** DVD player will output only NTSC system.  
**PAL:** DVD player will output only PAL system.

**Note:**

– When TV system selection did not match between the DVD player and the disc, the picture may appear distorted.

## Audio / Subtitle / Disc menu

DVD discs are available for multi-audio / subtitle / disc menu languages. Use these settings to choose your preferred default language.  
 Audio: English, French, Spanish, Chinese, ...etc.  
 Subtitle: English, French, Spanish, Chinese, ... etc.  
 Disc menu: English, French, Spanish, Chinese, ... etc.

**Notes:**

- This feature is subject to availability of the disc.
- If the language selected is not available on the disc, the default language designated by each disc will be selected.

## Parental

Parental feature allows you to prevent discs from being played by your children or to have certain discs played with alternative scenes.  
 If you set a rating for the player, all scenes with the same rating or lower will be played.  
 The rating levels for selection:  
 1, 2, 3, 4, 5, 6, 7, 8 and No Parental.

## Password

You can change the setup of parental setting with a recognise password. Enter your password when required by the DVD player:

- 1 Enter the current 4 digit code.
  - 2 Move to NEW PASSWORD using the ▼ key.
  - 3 Enter the new 4-digit code.
  - 4 Enter the code a second time to reconfirm.
  - 5 Press PLAY key to exit the menu.
- The new 4 digit code will be take effect.



**Note:**

- If you forget the password, you can enter the default password 3308 and replace your password after logging in.

## Default

Use DEFAULT feature if problems occur during setting the DVD player: This feature will reset all settings to factory and all the personal settings will be erase.

# JPEG Picture and MP3 Playback

This DVD player can playback JPEG format pictures and MP3 files.

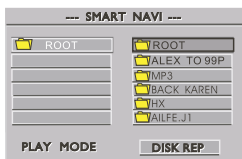

## Notes:

- The disc reading time may exceed 10 seconds due to the large number of songs compiled onto one disc.
- Playback of multi-session disc is supported for the first 10 sessions with the same format.
- For multi-session discs with different formats, only the first session will be available.

## JPEG Features

### Zoom

- 1 During playback, press zoom to display the picture with different scales.
- 2 Press FWD to enlarge picture scale.
- 3 Press REV to reduce picture scale.

### Multi-angles

When displaying one picture on TV screen, press the ◀▶▲▼ keys to get different angle effects.

- ▲ key: flip the picture vertically
- ▼ key: flip the picture horizontally
- ◀ key: rotate the picture anti-clockwise
- ▶ key: rotate the picture clockwise

### Preview

- 1 During playback, press PREVIEW.  
→ 9 reduced pictures will be displayed on the TV screen.
- 2 Press ◀▶▲▼ keys to highlight one of the picture and OK to display in full screen.

- 1 After loading a JPEG format/MP3 files disc, root menu will be displayed on the screen automatically.
- 2 Press ▲/▼ to scroll through the previous or next Album.
- 3 Press ◀/▶ to scroll through the Album or next Track.
- 4 You can also select the desired album/track number directly using the numeric keys on the remote control.

#### Note:

- In **STOP mode**: numbers are used for **ALBUM selection**.
  - In **PLAY mode**: numbers are used for **TRACK selection**.
- Only the following functions are possible for MP3 discs:
    - STOP/RETURN PLAY/PAUSE
    - SKIP NEXT / PREVIOUS
    - REPEAT (TRACK / ALBUM / DISC)

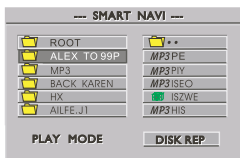

## MP3 Discs - Album/Track/Disc

- REPEAT TRACK - to repeat a track playback in all sequences.
- REPEAT ALBUM - to repeat an album playback in all sequences.
- ALBUM PLAYBACK - shuffle playback images in the selected folder within the first 10 seconds of each album/track on the disc.
- SKIP NEXT / PREVIOUS - use NEXT/PREV or numerical key pads to select your desired album/track. During playback, use FWD/REV to skip forward/backward of the current track/album.

## PLAYBACK SYSTEM

DVD Video  
 Video CD & SVCD  
 CD (CD-Recordable and CD-Rewritable)  
 MP3 CD

## TV STANDARD (PAL/50Hz) (NTSC/60Hz)

Number of lines	625	525
Playback	Multistandard	(PAL/NTSC)

## VIDEO PERFORMANCE

Video output	1 Vpp into 75 ohm
S-Video output	Y: 1 Vpp into 75 ohm C: 0.3 Vpp into 75 ohm
Component video output	Y: 1 Vpp into 75 ohm Pb/Cb Pr/Cr: 0.7 Vpp into 75 ohm

## AUDIO FORMAT

Digital	MPEG	Compressed Digital
	Dolby Digital	16, 20, 24 bits
	PCM	fs, 44.1, 48, 96 kHz

Analogue Stereo Sound

Dolby Surround-compatible downmix from Dolby Digital multi-channel sound

3D Sound for virtual 5.1 channel sound on 2 speakers  
 Dolby Digital and DTS surround sound outputs from 5.1 channels

## AUDIO PERFORMANCE

DA Converter	24 bits	
DVD	fs 96 kHz	4 Hz - 44 kHz
DVD/SVCD	fs 48 kHz	4 Hz - 22 kHz
SVCD/VCD/CD	fs 44.1 kHz	4 Hz - 20 kHz
Signal-Noise (1kHz)		> 90 dB
Dynamic Range (1kHz)		> 80 dB
Crosstalk (1kHz)		> 80 dB
Distortion and Noise (1kHz)		> 88 dB
MPEG MP3	MPEG Audio L3	

## CONNECTIONS

Y Output	Cinch (green)
Pb/Cb Output	Cinch (blue)
Pr/Cr Output	Cinch (red)
S-Video Output	Mini DIN, 4 pins
Video Output	Cinch (yellow)
Audio L+R output	Cinch (white/red)
Audio Subwoofer	Cinch (black)
5.1 Channel Audio	Mini DIN, 9 pins output
Digital Output	1 coaxial, 1 optical
	IEC958 for CDDA / LPCM
	IEC1937 for MPEG1/2, Dolby Digital

## CABINET

Dimensions (w x h x d)	228 x 56 x 296 mm
Weight	Approximately 2.32 Kg

\* typical playing time for movie with 2 spoken languages and 3 subtitle languages

**Specifications subject to change without prior notice**

# Maintenance

## Cleaning the Cabinet

- Use a soft cloth slightly moistened with a mild detergent solution. Do not use a solution containing alcohol, spirits, ammonia or abrasives.

## Cleaning Discs

- When a disc becomes dirty, clean it with a cleaning cloth. Wipe the disc from the centre out. Do not wipe in a circular motion.
- Do not use solvents such as benzine, thinner, commercially available cleaners, or antistatic spray intended for analogue records.

## Cleaning the disc lens

- After prolonged use, dirt or dust may accumulate at the disc lens. To ensure good playback quality, clean the disc lens with Philips CD Lens Cleaner or any commercially available cleaner. Follow the instructions supplied with the cleaner.

# Troubleshooting

## WARNING

*Under no circumstances should you try to repair the system yourself, as this will invalidate the warranty. Do not open the system as there is a risk of electric shock.*

*If a fault occurs, first check the points listed below before taking the system for repair.*

<b>Problem</b>	<b>Solution</b>
<b>No power</b>	<ul style="list-style-type: none"><li>– Check if the AC power cord is properly connected.</li></ul>
<b>No picture</b>	<ul style="list-style-type: none"><li>– Check if the TV is switched on.</li><li>– Check the video connection.</li></ul>
<b>Distorted picture</b>	<ul style="list-style-type: none"><li>– Sometimes a small amount of picture distortion may appear. This is not a malfunction.</li></ul>
<b>Completely distorted picture or black/white picture with DVD or Video CD</b>	<ul style="list-style-type: none"><li>– Make sure the NTSC/PAL setting at the DVD player matches the video signal of your television. (See NTSC/PAL Conversion/Settings)</li></ul>
<b>No sound or distorted sound</b>	<ul style="list-style-type: none"><li>– Adjust the volume.</li><li>– Check that the speakers are connected correctly.</li></ul>
<b>No audio at digital output</b>	<ul style="list-style-type: none"><li>– Check the digital connections.</li><li>– Check the settings menu to make sure the digital output is set to ALL or PCM.</li><li>– Check if the audio format of the selected audio language matches your receiver capabilities.</li></ul>
<b>No sound and picture</b>	<ul style="list-style-type: none"><li>– Check that the cables is connected to the correct device (See Connecting to a TV)</li></ul>
<b>Picture freezes momentarily during playback</b>	<ul style="list-style-type: none"><li>– Check the disc for fingerprints/scratches and clean with a soft cloth wiping from centre to edge.</li></ul>
<b>Disc can't be played</b>	<ul style="list-style-type: none"><li>– Ensure the disc label is facing up.</li><li>– Check if the disc is defective by trying another disc.</li></ul>
<b>No return to start-up screen when disc is removed</b>	<ul style="list-style-type: none"><li>– Reset the unit by switching the player off, then on again.</li></ul>
<b>The player does not respond to the remote control</b>	<ul style="list-style-type: none"><li>– Aim the remote control directly at the sensor on the front of the player.</li><li>– Reduce the distance to the player.</li><li>– Replace the batteries in the remote control.</li><li>– Re-insert the batteries with their polarities (+/– signs) as indicated.</li></ul>
<b>Buttons do not work or player stops responding</b>	<ul style="list-style-type: none"><li>– To completely reset the player, unplug the AC cord from the AC outlet for 5-10 seconds.</li></ul>
<b>Player does not respond to some operating commands during playback.</b>	<ul style="list-style-type: none"><li>– Operations may not be permitted by the disc. Refer to the instructions of the disc.</li></ul>
<b>DVD Video player cannot read CDs/DVDs</b>	<ul style="list-style-type: none"><li>– Use a commonly available cleaning CD/DVD to clean the lens before sending the DVD player for repair.</li></ul>

***If you are unable to remedy a problem by following these hints, consult your dealer or service centre.***