

CONTENTS

INTRODUCTIONP 7

INSTALLATIONP 9

STANDARD CONNECTIONSP 11

GETTING STARTEDP 14

PLAYING A DVD-VIDEO DISCP 15

PLAYING A VIDEO CDP 18

PLAYING AN AUDIO CDP 20

SETTINGSP 22

PARENTAL CONTROLP 24

BEFORE REQUESTING SERVICEP 25

DVD-VIDEO

PRODVD-VIDEO: THE MEDIUM OF CHOICE FOR PROFESSIONAL CUSTOMERS

The professional DVD player provides all the advantages of DVD-video and more. Additional control devices like for example touch screens or wired controls can easily be connected. Next to that the Professional player is featured with NVRAM memory to store and retrieve results or settings. This player is the ideal medium for kiosk, training or business presentation applications.

Video was never like this before! Perfect digital, studio-quality pictures with truly 3-dimensional digital multichannel audio. Story sequences viewed on screen from your own choice of camera angle.

Language barriers are broken down by sound tracks in as many as eight languages, plus subtitling - if available on disc - in as many as 32. And whether you watch DVD-Video on wide-screen or regular TV, you always see it the way it was meant to be seen.

Manufactured under license from Dolby Laboratories. "Dolby" and the double-D symbol are trademarks of Dolby Laboratories. Confidential Unpublished Works. ©1992-1997 Dolby Laboratories, Inc. All rights reserved.

DIGITAL VIDEO

DVD-Video uses state-of-the-art MPEG2 data compression technology to register an entire movie on a single 5-inch disc. DVD's variable bit-rate compression, running at up to 9.8 Mbits/second, captures even the most complex pictures in their original quality.

The crystal-clear digital pictures have a horizontal resolution of over 500 lines, with 720 pixels (picture elements) to each line. This resolution is more than double that of VHS, superior to Laser Disc, and entirely comparable to the digital masters made in recording studios.

DVD-Video discs conform to either the PAL or NTSC video standard. This dual-standard player can play both types and present them in the best possible way on your multistandard TV screen.

As the universal video system of the future, DVD-Video offers optimum viewing on any TV screen.

INTRODUCTION

INTRODUCTION

Your Philips DVD-Video player plays digital video discs conforming to the universal DVD-Video standard. With it, you will be able to enjoy full-length movies with true movie-theater picture quality and stereo or multichannel sound (depending on the disc and on your player set-up). The unique features of DVD-Video, including selecting sound track and subtitting languages, and different camera angles (again depending on the disc), are all included. What is more: Philips Parental Control lets you decide which discs your children will be able to view.

You will find your player remarkably easy to use, based on the On-Screen Display and player display in combination with the remote control.

In addition to DVD-Video discs, you will also be able to play all Video CDs and audio CDs. The disc types that run on the player feature one or more of these logos on the disc packaging:



UNPACKING

First check and identify the contents of your DVD-Video player package, as listed below:

- DVD-Video player
- Remote Control Handset with separately-packed batteries
- 3-core power cord
- A/V Euroconnector cable (Europe)
- S-Video (USA)
- 1-way video (CVBS) cable
- 2-way audio cable
- User Manual

If any item should be damaged or missing, please immediately inform your supplier.

Keep the packaging materials; you may need them to transport your player in the future.

PLACEMENT

- Place the player on a sturdy, flat surface.
- Keep away from domestic heating equipment and avoid direct sunlight.
- In a cabinet, allow about 1 inch of free space all around the player for adequate ventilation.

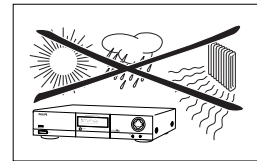

- If your DVD-Video player fails to read discs correctly, use a commonly-available cleaning CD/DVD to clean the lens before taking the DVD-Video player for repair. Avoid other cleaning methods, because these may damage the lens. Always keep the tray closed to avoid getting dust on the lens.
- The lens may cloud over when the DVD-Video player is suddenly moved from cold to warm surroundings, in which case it will not be possible to play a CD/DVD. Leave the DVD-Video player in the warm environment until the moisture evaporates.

OPTIONAL PRODUCTS/ACCESSORIES

- 17" Touch screen
- 21" Touch screen
- Wired pointing device
- Technical manual
- 19" Rack Mounting brackets
- Bar-code reader box (planned)
- Communication unit (planned)

For more information, please contact:

Philips Consumer Electronics

Annemiek Braken

Tel. +31 40 273 53 89

Fax +31 40 273 63 34

E-mail annemiek.braken@ehv.ce.philips.com

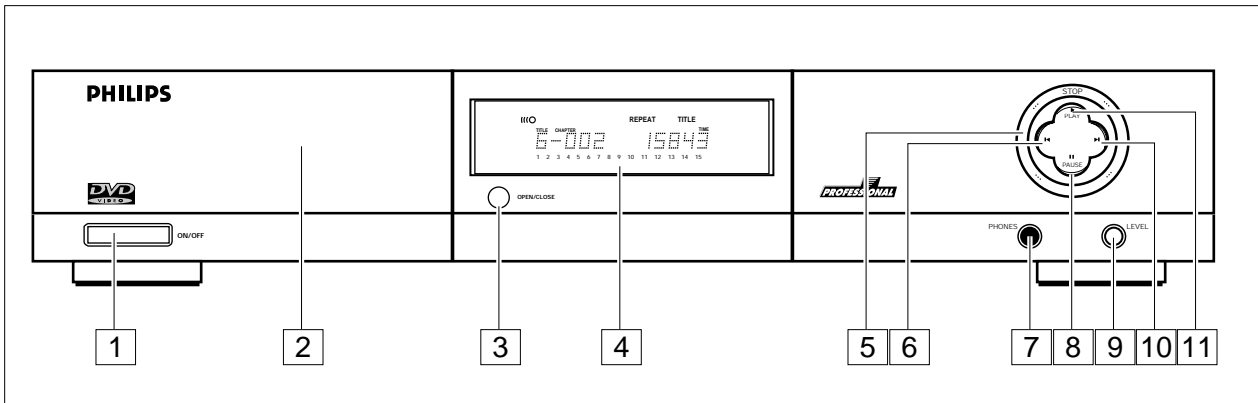

FRONT OF PLAYER

- 1 ON/OFF
- 2 Disc tray (behind door)
- 3 Tray OPEN/CLOSE key
- 4 Display
- 5 ■ STOP
- 6 ◀ Previous title/chapter/track
- 7 PHONES; Headphone jack
- 8 || PAUSE/Still/Step
- 9 LEVEL; Headphone volume control
- 10 ▶ Next title/chapter/track
- 11 ▶ PLAY

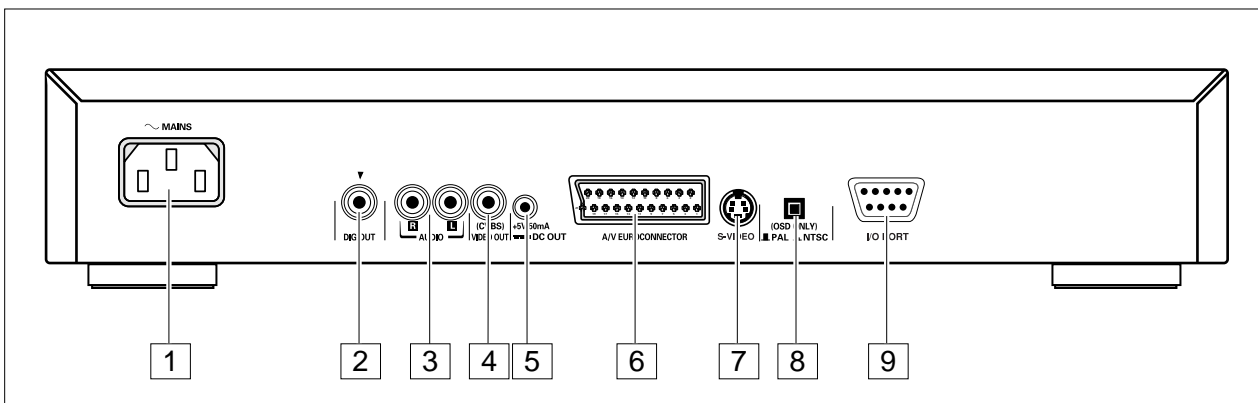

REAR OF PLAYER

- 1 Power supply
- 2 Digital audio output
- 3 Audio R; Audio output R
Audio L; Audio output L
- 4 Video (CVBS); Video output
- 5 DC Power output (for optional external RF modulator)
- 6 A/V Euroconnector (Europe)
- 7 S-Video (USA)
- 8 NTSC/PAL switch (for player menus)
- 9 I/O Port

CAUTION

Do not touch the pins in the rear-panel connectors. Electrostatic discharge may cause permanent damage to the unit.

INSTALLATION

DISPLAY

- 1 Remote control active (flashing)
- 2 FTS active
- 3 SHUFFLE active
- 4 PAUSE active
- 5 SCAN active
- 6 REPEAT A-B/CHAPTER/TITLE/TRACK mode active
- 7 Chapter or track calendar
- 8 TOTAL/REMaining/TRACK TIME in hours, minutes and seconds
- 9 (V)CD disc inserted
- 10 DVD disc inserted
- 11 DVD CHAPTER or VCD/CD TRACK number
- 12 DVD TITLE number

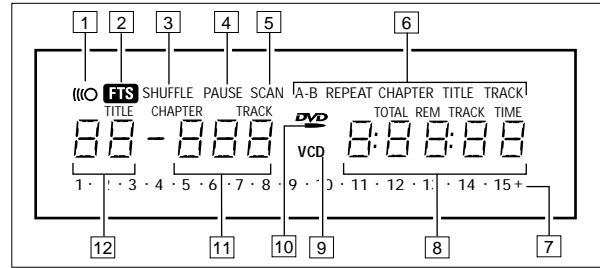

REMOTE CONTROL

- 1 **OSD**(On-Screen Display) on/off
- 2 **ANGLE**select DVD camera angle
SUBTITLE..language selector or subtitling on/off
AUDIOspoken language selector
- 3 **0-9**.....numeric key pad
- 4 **T-C**title/chapter mode selector
- 5 **MENU**select DVD-defined menu
OK.....acknowledge menu selection.
up/down/left/right cursor movement
- 6 **◀◀ ◀**previous chapter or track / search back
▶▶ ▶next chapter or track/ search forward
▶.....play
⏸pause or still frame /step frame
▶slow motion (1/2, 1/4, 1/8 speed)
■.....stop
- 7 **SETUP**select player settings menu (in stop mode only)
REPEAT*/A-B REPEAT chapter, track, title, disc
SHUFFLE/SCAN* shuffle or scan on/off
- 8 **RETURN**.....go back to previous menu step
- 9 **⏻**standby/Power ON

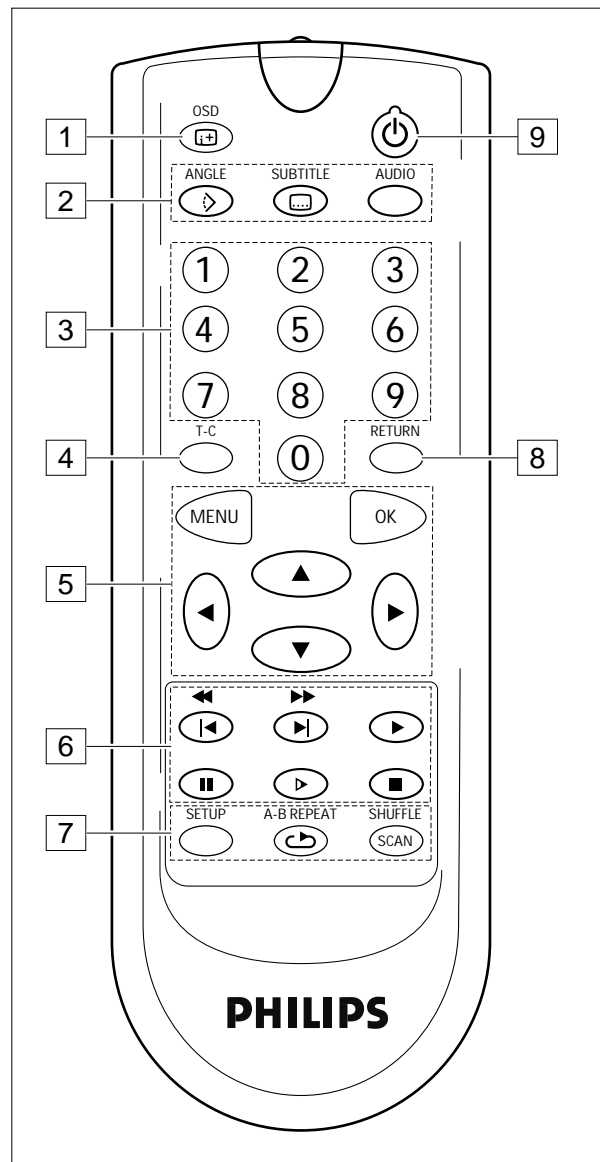

* Press key for about 1 second

STANDARD CONNECTIONS

GENERAL NOTE

- Depending on your TV and other equipment, there are various ways in which the DVD-Video player can be connected. These are shown below.

- Please refer to your TV, VCR, Stereo System and any other User Manual(s) as necessary to determine the optimum configuration.

HIGHEST QUALITY A/V CONNECTION (EUROPE)

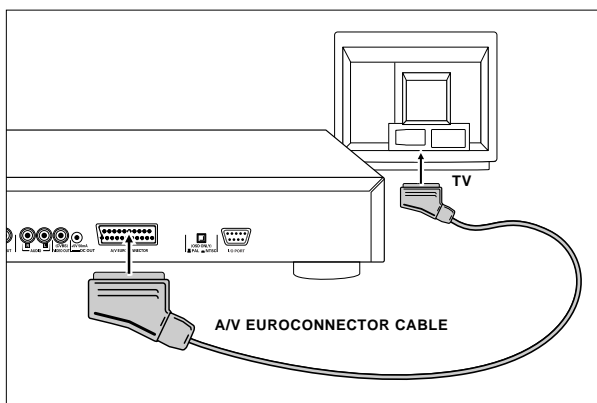

Connection to a TV with an A/V Euroconnector jack.

- 1 Connect the A/V Euroconnector on the rear of the player to the corresponding connector on the TV using the cable supplied.
- 2 You can also opt to connect the audio Left and Right channel jacks on the rear of the player to the corresponding jacks on your stereo system.

NOTE

- Do not connect your DVD-player via your VCR, because the video quality could be distorted by the copy protection system.

HIGHEST QUALITY A/V CONNECTION (USA)

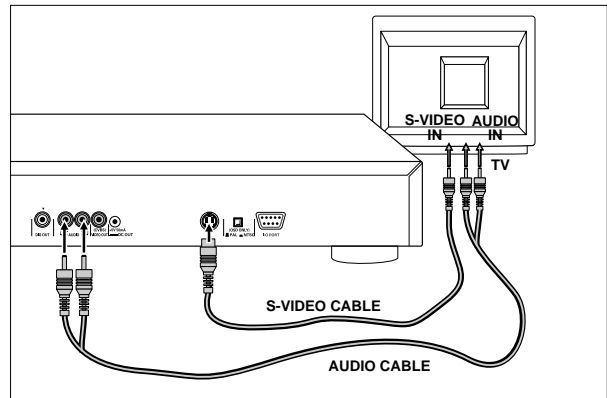

Connection to a TV with an S-Video jack.

- 1 Connect the S-Video on the rear of the player to the corresponding connector jack on the TV using the cable supplied.
- 2 Connect the audio Left and Right channel jacks on the rear of the player to the corresponding jacks on the TV using the cable supplied. Alternatively, you can use the same cable to connect the audio Left and Right jacks on the rear of the player to the corresponding jacks on your stereo system.

STANDARD CONNECTIONS

EXCELLENT A/V CONNECTION

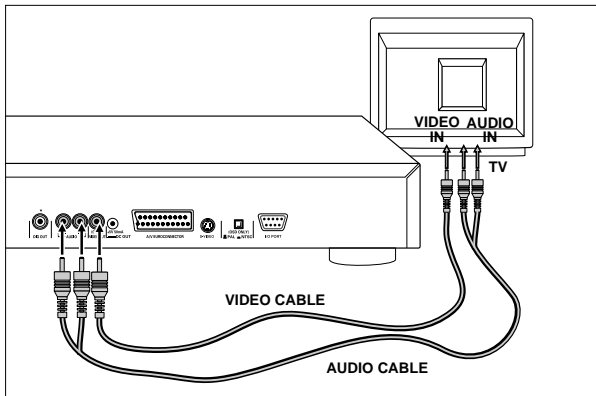

Connection to a TV with a video (CVBS) jack.

- 1 Connect the Video jack on the rear of the player to the corresponding jack on the TV using the cable supplied.
- 2 Connect the audio Left and Right channel jacks on the rear of the player to the corresponding jacks on the TV using the cable supplied. Alternatively, you can use the same cable to connect the audio Left and Right jacks on the rear of the player to the corresponding jacks on your stereo system.

CAUTION

Do not connect the player's audio output to the phono input of your stereo system.

MULTICHANNEL SOUND FOR HOME THEATRE

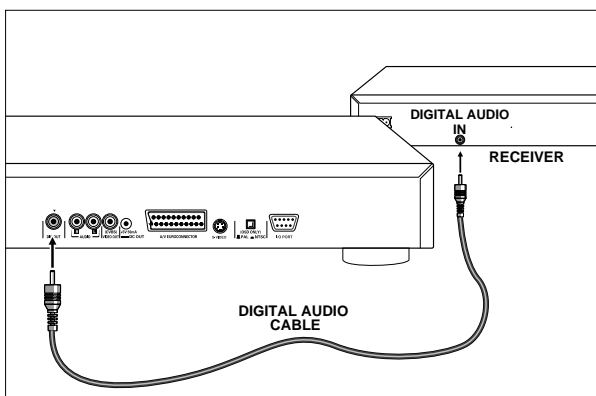

For multichannel sound, your player provides both digital and analogue audio outputs.

DIGITAL (MPEG 2 MULTICHANNEL OR DOLBY DIGITAL) MULTICHANNEL SOUND

- 1 For this, the highest multichannel sound quality, you need a digital multichannel A/V receiver.
- 2 Connect the digital audio output on the rear of the player to a suitable input on the receiver using a digital audio cable. In this case, do not use the player's audio Left and Right outputs.
- 3 You will need to activate the digital output of the player (See Settings p. 22).
- 4 The audio format of the digital output is dependent on the audio format of the selected audio channel. Make sure that the selected audio channel matches the capabilities of the receiver connected to the digital output.

ANALOGUE (DOLBY PRO LOGIC) MULTICHANNEL SOUND

- 1 If your TV set has a Dolby Pro Logic decoder, simply hook up the player to the TV using the A/V Euroconnector, S-Video and audio or Video (CVBS) and audio connections p. 11.
- 2 If not, make the A/V Euroconnector, S-Video or Video (CVBS) connection to the TV p. 11, and connect the player's audio Left and Right outputs to suitable inputs on a Dolby Pro Logic Audio/Video receiver, using the cable supplied.
- 3 For speaker connections, follow the instructions given in the TV set or A/V receiver user manual.

NOTE

- You cannot use the RF modulator option for Home Theater.

- If the audio format of the digital output does not match the capabilities of your receiver, the sound will be muted.

DIGITAL AUDIO (STEREO) SOUND CONNECTION

For this connection, giving the best possible stereo sound quality, you need an audio amplifier with digital input, and the digital output of the player must be activated. Connect the player's digital audio output to the corresponding input on the amplifier. In this case, do not use the player's audio Left and Right outputs.

Caution:

Before connecting the player's digital audio output to your audio system, make sure that the disc doesn't contain digital control data for non-audio devices (i.e. controller).

NTSC/PAL SETTING

Use the NTSC/PAL switch on the rear of the player to set the player menu according to the standard used by your TV set. To activate the new setting, the player needs to be switched off and on again.

NOTE

- The video output standard for video CD and DVD-Video discs must correspond to the disc being played.

HEADPHONES

To listen to the player sound directly through headphones, plug the headphone into the headphone jack on the front of the player. Adjust the volume as desired with the headphone volume control.

CONNECTING THE POWER SUPPLY

- 1 Plug the feed end of the power cord supplied into the Power connector on the rear of the player.
- 2 Plug the supply end of the cord into an AC outlet.

NOTE

- The player automatically adjusts to the local AC voltage.

- When the player is in the "OFF" position, it still consumes some power. If you wish to disconnect your player completely from the power supply, pull the plug from the AC Outlet.

CAUTION

Only qualified service personnel should remove the cover or attempt to service this appliance.

INFRARED REMOTE CONTROL

LOADING THE BATTERIES

- 1 Open the battery compartment cover.
- 2 Insert two 'AAA' (R03) batteries as indicated inside the battery compartment.
- 3 Close the cover.

CAUTION

Do not mix old and new batteries, and NEVER mix different types of batteries (standard, alkaline, rechargeables, etc.).

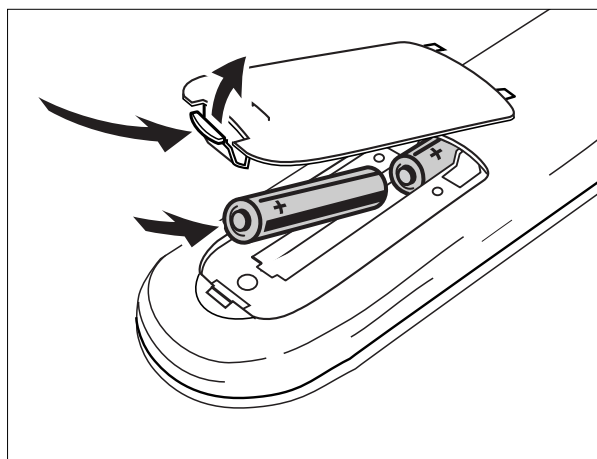

GETTING STARTED

OPERATION

NOTE

- Unless indicated otherwise, all operations can be performed using the remote control. Always point the remote control directly at the player, making sure there are no objects obstructing the path of the infrared beam.

- When there are corresponding keys on the front panel, these can also be used.

SWITCHING ON

- 1 Switch on the TV and select the video input for your DVD-Video player.
- 2 To enjoy sound through your stereo system, turn on the system and select the source input for the DVD-Video player, or:
To enjoy DVD-Video with multichannel (surround) sound, switch on the Home Theater system and select the source input for your DVD-Video player.
- 3 On the front of the DVD-Video player, press ON/OFF. The player display will light up, and the OSD invites you to insert a disc.
- 4 When Autoplay is ON (the factory setting), any disc already inserted in the player will start to play.



INSERTING A DISC

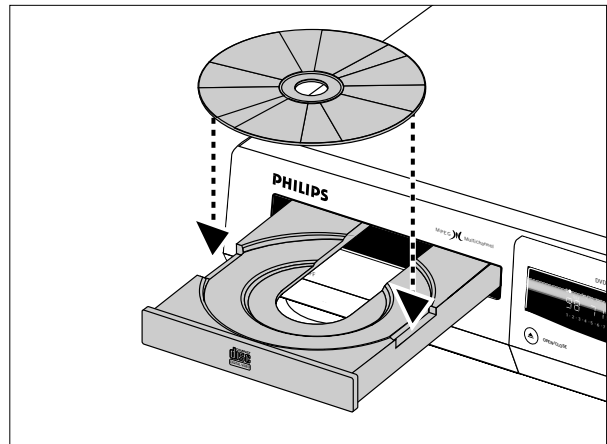

- 1 Press Open/Close on the front of the player. The disc tray will open.
- 2 Put the disc you have selected into the tray, label side up. Make sure it fits properly into the correct recess.
- 3 Gently push the tray, or press Open/Close, to close the tray.
 - When Autoplay is ON (the factory setting), play starts.
 - When Autoplay is OFF, the (play) screen for the type of disc inserted will appear on the OSD, and information about the disc's contents and total playing time will appear on the display.
 - To switch Autoplay off or on, see Settings (p. 22).

NOTE

- Because DVD movies are usually released at different times in different parts of the world, all players have region codes, and discs may have an optional region code. If you insert a disc with a different region code into your player, you will see the region code notice on the screen. The disc will not play, and should be removed.

PLAYING A DVD-VIDEO DISC

PLAYING A DVD-VIDEO DISC

You will recognize DVD-Video discs by the logo. Depending on the material on the disc (a movie, video clips, a drama series, etc.) it may have one or more Titles, and each Title may have one or more Chapters. Play stops at the end of each Title. For easy and convenient access, you can move between Titles and between Chapters with your player.

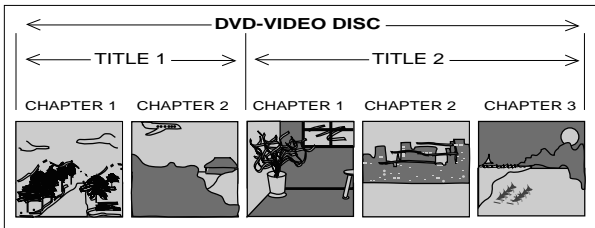

NOTE

- During play, a variety of icons will appear on the TV screen for about 2 seconds to confirm that a function has been selected. You can remove these icons by pressing OSD.

- At any time during play, you can press OSD to view the Play Bar, which indicates which functions are active, for about 2 seconds. To keep the Play Bar on the screen, press OSD for a couple of seconds. To remove the Play Bar, press OSD again.

- List of icons:

Play
Pause
Stop
A-B repeat
Search forward
Search backward
Slow forward
Repeat disc
Repeat title
Repeat chapter
Chapter shuffle
Title indication
Chapter indication
Disable function
Angle
No alternative angle
Subtitle language

Audio language
Audio system
Remaining time of title
Elapsed time
Resume
Total time

PLAYING A TITLE

- When Autoplay is ON, play will start when you close the disc drawer.
- When Autoplay is OFF, press ►.

NOTE

- Some DVD-Video discs carry their own Autoplay, in which case play always starts automatically.

- The disc may invite you to select an item from a menu. If the selections are numbered, press the appropriate numeric key; if not, use to highlight your selection, and press OK.
 - As the disc plays, the player display will indicate the current title and chapter and the elapsed playing time.
- Play will stop at the end of a Title, and this may result in returning to the menu. To go on to the next Title, press ►.
- To stop play at any other time, press ■.
- You can resume play from the point at which you stopped. Press ► twice.
- The RESUME feature applies not only to the disc in the player, but also to the last four discs you have played. Simply reload the desired disc, press ► if Autoplay is OFF, and when you see the Resume icon on the screen, press ► again.

MOVING TO ANOTHER CHAPTER

When a title on a disc has more than one chapter (this is indicated on the player display), you can move to another chapter as follows:

- Press ► briefly during play to move forward to the next chapter.
- Press ◀ briefly during play to return to the beginning of the current chapter. Press ◀ briefly again to go back to the beginning of the previous chapter.

PLAYING A DVD-VIDEO DISC

- To go directly to any chapter, enter the chapter number using the numeric keys.

NOTE

- If the number has more than one digit, press the keys in rapid succession.

- For more information about chapters, see "Checking the contents of DVD-Video discs: Menus" p. 17.

MOVING TO ANOTHER TITLE

When a disc has more than one title (indicated both on the OSD and on the player display when you press **■**), you can move to another title as follows:

- Press T-C, then press **▶** briefly during play to move forward to the next title.
- Press T-C, then press **◀** briefly during play to return to the beginning of the current title. Press **◀** briefly again to go back to the previous title.
- To go directly to any title, press T-C, then enter the title number using the numeric keys.

NOTE

- If the number has more than one digit, press the keys in rapid succession.

- For more information about titles, see "Checking the contents of DVD-Video discs: Menus" p. 17.

PARENTAL CONTROL



- If you activate Parental Control, only discs that you have already authorized as suitable for all ages can be played as above.
- To play any other DVD-Video disc, the OSD will ask you to enter your Parental Control PIN code. After the correct code has been entered, play starts automatically.
- To activate Parental Control, and to authorize discs, see Activating Parental Control (p. 24).

NOTE

- If you forget your PIN code, you can erase it when the code is requested as above by pressing **■** four times. Parental Control will then be de-activated. To re-activate it, see Activating Parental Control (p. 24).

STILL PICTURE AND STEP FRAME

- To get a still picture, press **■** during play.
- To go forward to the next picture frame, press **■** again.
- To return to play, press **▶**.

SEARCH

- To search forward or backward through the disc at 4x normal speed, press **▶** or **◀** for about 1 second during play.
→ Search begins and sound is muted.
- To increase the speed up to 32x normal speed, press **▶** or **◀** again.
- To go directly to 32x normal speed, hold down **▶** or **◀** until the **▶▶▶▶** or **◀◀◀◀** icon appears.
- To return to 4x normal speed, press **▶** or **◀** again.
→ Search speed and direction are indicated on the screen for 2 seconds each time **▶** or **◀** is pressed
- To end the search, press **▶**, **■**, **▶** or **■** as desired.

SLOW MOTION

- Press **▶** to play video at 1/2 normal speed with sound muted.
- Press **▶** again to play at 1/4 normal speed.
- Press **▶** again to play at 1/8 normal speed.
- Press **▶** again to play video at 1/2 normal speed
- Playing speed is indicated on the screen for 2 seconds each time the button is pressed.
- To exit from the slow motion mode, press **▶**, **■**, **◀▶** or **■** as desired.

SHUFFLE

This shuffles the playing order of chapters within a title, if the title has more than one chapter.

- Press SHUFFLE briefly during play.
→ **chapter shuffle** appears on the screen for about 2 seconds.

PLAYING A DVD-VIDEO DISC

- As each chapter is played, its number disappears from the track calendar.
- To return to normal play, press SHUFFLE briefly again.

REPEAT CHAPTER/TITLE/DISC



- To repeat the chapter that is currently playing, press REPEAT for about 1 second:
→ REPEAT CHAPTER appears on the player display.
- To repeat the title that is currently playing, press REPEAT a second time for about 1 second:
→ REPEAT TITLE appears on the display.
- To repeat the entire disc, press REPEAT a third time for about 1 second:
→ REPEAT appears on the display.
- To exit from the Repeat mode, press REPEAT a fourth time for about 1 second.

A-B REPEAT

To repeat or loop a sequence in a title:

- Press A-B REPEAT briefly at your chosen starting point:
→ A appears on the player display.
- Press A-B REPEAT briefly again at your chosen end point:
→ A-B appears on the display, and the repeat sequence begins.
- To exit from the sequence, press A-B REPEAT briefly again.

CAMERA ANGLE

- If the disc contains sequences recorded from different camera angles, the angle icon appears , indicating the number of available angles and the angle being shown. You can then change the camera angle if you wish.
- To get another angle, press ANGLE .
→ The angle icon will indicate the next angle.
- To go directly to a certain angle, enter the desired angle number using the numeric keys.

NOTE



- The angle icon remains on the screen until you turn off the angle feature.

- To turn off the angle feature, press OSD :
→ the angle icon disappears.



- To turn the angle feature on again, press angle  again:
→ the angle icon reappears.

CHANGING THE AUDIO LANGUAGE AND CHANNEL CONFIGURATION

This changes the language and the audio channel configuration if alternatives are available on the disc.

- Press Audio during play.
→ The audio language and channel configuration icons appear on the screen for 2 seconds.

- Press Audio repeatedly to move through the options.
→ After each move, the language changes. If the sound configuration changes as well (for example from multichannel to stereo), this is also indicated.

SUBTITLING

- When subtitling is available on a disc, you can activate it by pressing the SUBTITLE  key during play until the subtitling appears.
- To move through the available language options, briefly press SUBTITLE  repeatedly.
- To deactivate the subtitling, press SUBTITLE  again.

SCAN

Plays the first 10 seconds of each title on the disc.

- Press SCAN for about 1 second.
- To continue play at the selected title, press SCAN again for about 1 second or press ►.

CHECKING THE CONTENTS OF DVD-VIDEO DISCS: MENUS

For titles and chapters, selection menus may be included on the disc. The DVD player's menu feature allows you to make selections from these menus. Press the appropriate numeric key; or use  to highlight your selection, and press OK.

- Press MENU.
→ If the present title has a "root" menu, this will now appear on the OSD.
- The "root" menu can list camera angles, spoken language and subtitling language options, and chapters for the title.
- To exit from the "root" menu, press MENU again.
- Press T-C followed by MENU.

PLAYING A VIDEO CD

→ If the disc has a title menu, this will now appear on the OSD.

- To remove the title menu, press T-C again.

PLAYING A VIDEO CD

You will recognize Video CDs by their logo. Depending on the material recorded on the disc (a movie, video clips, a drama series, etc.) it may have one or more tracks, and tracks may have one or more indexes, as indicated on the disc case. For easy and convenient access, you can move between tracks, and between indexes with your DVD player.



Some Video CDs have Playback Control (PBC), which is a pre-defined playback sequence stored on the disc.

NOTE

- During play, a variety of icons will appear on the TV screen for about 2 seconds to confirm that a function has been selected. You can remove these icons by pressing OSD.

- At any time during play, you can press OSD to view the Play Bar, which indicates which functions are active, for about 2 seconds. To keep the Play Bar on the screen, press OSD for a couple of seconds. To remove the Play Bar, press OSD again.

- List of icons:

Play
Pause
Stop
A-B repeat
Search forward
Search backward
Slow forward
Repeat disc
Repeat track
Shuffle
Track indication
Index indication
Remaining time of title
Elapsed time
Total time

PLAYING A DISC

- When Autoplay is ON, play starts when the disc drawer is closed.
- When Autoplay is OFF, press ►.
- As the disc plays, the display indicates the current track and the elapsed playing time.
- Play will stop at the end of the disc.
- To stop play at any other time, press ■.
- You can resume play from the point at which you stopped. Press ► twice.
- The RESUME feature applies not only to the disc in the player, but also to the last four discs you have played. Simply re-insert the desired disc, press ► if Autoplay is OFF, and when you see the Resume icon on the screen , press ► again.

MOVING TO ANOTHER TRACK

When a disc has more than one track (which you can see on both the OSD and the player display if you press ■), you can move to another track as follows:

- Press T-C, then press ► briefly during play to move forward to the next track.
- Press T-C, then press ◀ briefly during play to return to the beginning of the current track. Press ◀ briefly again to move back to the beginning of the previous track.
- To go directly to any track, press T-C, then enter the track number using the numeric keys.

NOTE

- If the number has more than one digit, press the keys in rapid succession.

MOVING TO ANOTHER INDEX

When a track has more than one index (as indicated on the disc case), you can move to another index as follows:

- Press ► briefly during play to move forward to the next index.
- Press ◀ briefly during play to move back to the beginning of the current index. Press ◀ briefly again to move back to the beginning of the previous index.
- To go directly to any index, enter the index number using the numeric keys.

NOTE

- If the number has more than one digit, press the keys in rapid succession.

PLAYBACK CONTROL (PBC)

- Insert a Video CD with PBC and press ►.
→ The PBC menu appears on the TV screen.
- Move through the menu using the keys indicated on the TV screen until the desired passage starts to play. If a PBC menu consists of a list of titles, you can select a title directly.
- Enter your choice with the ◀, ▶ or numeric keys.
- Press ► to start play of the selected title.
- Press RETURN to go back to the previous menu.

PARENTAL CONTROL

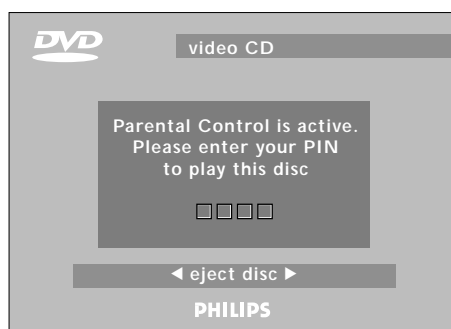

- If you activate Parental Control, only discs that have already been authorized as suitable for all ages can be played as above.
- To play any other Video CD, the OSD will ask you to enter your Parental Control PIN Code. When this has been done, play will start automatically.
- To activate Parental Control, and to authorize discs, see Activating Parental Control (p. 24).

NOTE

- If you forget your PIN code, you can erase it when the code is requested as above, by pressing ■ four times. Parental Control will then be de-activated. To re-activate it, see Activating Parental Control (p. 24).

STILL PICTURE AND STEP FRAME

- To get a still picture, press ■ during play.
- To move forward to the next picture frame, press ■ again.
- To return to play, press ►.

SEARCH

- To search forward or backward through the disc at 4x normal speed, press ► or ◀ for about 1 second during play.
→ Search begins and sound is muted.
- To increase the speed to 32x normal speed, press ► or ◀ again.
- To go directly to 32x normal speed, hold down ► or ◀ until the ►► or ◀◀ icon appears.
- To return to 4x normal speed, press ► or ◀ again.
→ Search speed and direction are indicated on the screen for 2 seconds each time ► or ◀ is pressed.
- To end the search, press ►, ■, ► or ■ as desired.

SLOW MOTION

- Press ► to play video at 1/2 normal speed with sound muted.
- Press ► again to play at 1/4 normal speed.
- Press ► again to play at 1/8 normal speed.
- Press ► again to play video at 1/2 normal speed.
- The playing speed is indicated on the screen for 2 seconds each time the key is pressed.
- To exit from slow motion mode, press ►, ■, ◀/► or ■ as desired.

SHUFFLE

This shuffles the playing order of the tracks, if there are two or more tracks on the disc.

- Press SHUFFLE briefly during play.
→  appears on the screen for about 2 seconds.
- As each track is played, its number disappears from the track calendar.
- To return to normal play, press SHUFFLE briefly again.

REPEAT TRACK/DISC

- To repeat the track that is currently playing, press REPEAT for about 1 second:
→ REPEAT TRACK appears on the player display.
- To repeat the entire disc, press REPEAT a second time for about 1 second;
→ REPEAT appears on the display.

- To exit from the Repeat mode, press REPEAT a third time for about 1 second.

A-B REPEAT

To repeat or loop a sequence:

- Press A-B REPEAT briefly at the desired starting point; → **A** appears on the player display.
- Press A-B REPEAT briefly again at the desired end point; → **A-B** appears on the display, and the repeat sequence will begin.
- To exit the sequence, press A-B REPEAT briefly again.

SCAN

Plays the first 10 seconds of each title on the disc.

- Press SCAN for about 1 second.
- To continue play at the desired title, press SCAN again for about 1 second or press ►.

PLAYING AN AUDIO CD

Audio CDs contain music tracks only. You will recognize these CDs by their logo.



You can play audio CDs using the OSD or through a stereo system only, using keys on the remote control and/or front panel.

PLAYING A DISC

- When Autoplay is ON, play will start when the disc drawer is closed.
- When Autoplay is OFF, press ►.
→ The disc will start to play; if the TV is on, the CD Play screen appears on the OSD.

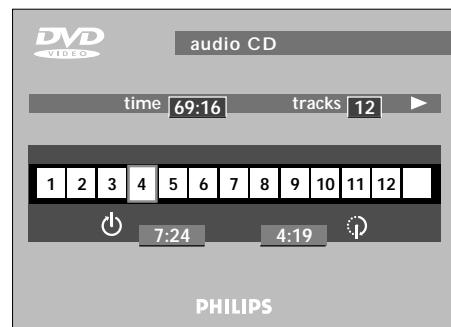

→ Play will stop at the end of the disc.

- To stop play at any other time, press ■.

PAUSE

- Press **||** during play.
- To return to play, press ►.

SEARCH

- To search forward or backward through the disc at 4x normal speed, briefly press ► or ◀ for about 1 second during play.
→ Search will begin, and the sound will be partially muted.
- To increase the speed to 8x normal speed, briefly press ► or ◀ again.
→ Search goes to 8x speed, and the sound is muted.
- To go directly to 8x normal speed, press ► or ◀ until the ►8 or ◀8 icon appears.
- To return to 4x normal speed, briefly press ► or ◀ again.

- If the TV is on, the search speed and direction are indicated on the screen each time ► or ◀ is pressed.
- To end the search, press ►, ||, or ■ as desired.

MOVING TO ANOTHER TRACK

- Press ► briefly during play to move forward to the next track.
- Press ◀ briefly during play to move back to the beginning of the current track. Press ◀ briefly again to move back to the beginning of the previous track.
- To go directly to any track, enter the track number using the numeric keys.

NOTE

- If the number has more than one digit, press the keys in rapid succession.

SHUFFLE

- Press SHUFFLE briefly during play.
 - The order in which the tracks are played will be randomly selected.
- As each track is played, its number disappears from the player display.
- To return to normal play, press SHUFFLE briefly again.

REPEAT TRACK/DISC

- To repeat the track that is currently playing, press REPEAT for about 1 second:
 - REPEAT TRACK appears on the display.
- To repeat the entire disc, press REPEAT a second time for about 1 second:
 - REPEAT appears on the display.
- To exit Repeat mode, press REPEAT a third time for about 1 second.

A-B REPEAT

To repeat or loop a sequence:

- Press A-B REPEAT briefly at the desired starting point;
 - A appears on the player display.
- Press A-B REPEAT briefly again at the desired end point;
 - A-B appears on the display, and the repeat sequence begins.
- To exit the sequence, briefly press A-B REPEAT again.

SCAN

Plays the first 10 seconds of each title on the disc.

- Press SCAN for about 1 second.
- To continue play at the desired title, press SCAN again for about 1 second or press ►.

FTS (FAVORITE TRACK SELECTION)

NOTE

- FTS Favorite Track Selections are compiled and played using the OSD: ensure that the TV is on.

Playing an FTS program

If Auto FTS is activated, the FTS program will start to play immediately. If Auto FTS is off:

- 1 Insert a disc and go to Stop mode.
- 2 Press or to start compiling FTS programs.
- 3 If available, the existing FTS program appears.
- 4 Follow instructions under "To exclude tracks" or "To select tracks".

To turn Auto FTS on and off, see Settings, p. 22

Compiling an FTS program

FTS programs can be compiled by selecting the tracks you want to play ("Track Selection") or by excluding the tracks you don't want to play ("Excluding Tracks")

To exclude Tracks:

- 1 Insert a disc and go to Stop mode.
- 2 Press .
- 3 Use or to move to the first track number you want to exclude.
- 4 Press .
- 5 Repeat steps 3 and 4 to exclude other track numbers in the same way. If you change your mind, you can re-include any track number by moving back to it and pressing .
- 6 To clear your whole selection and start again, press ■.

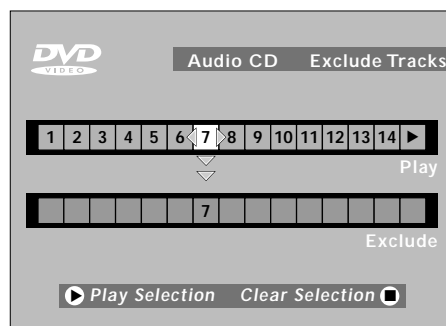

To select Tracks:

- 1 Insert a disc and go to Stop mode.
- 2 Press .
- 3 Use or to move to the first track number you want to select.
- 4 Press .
- 5 Repeat steps 3 and 4 to select other track numbers in the same way. If you change your mind, you can de-select track numbers in reverse order by pressing as required.
- 6 To clear your whole selection and start again, press ■.

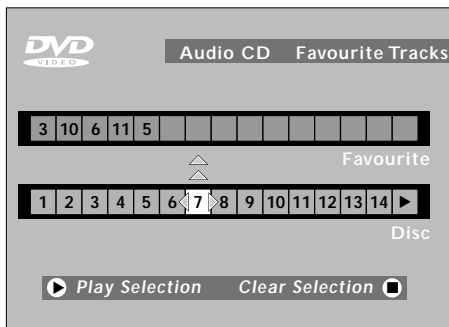

When your FTS program is complete, press ► to start play, or RETURN to go back to Stop mode. In either case, the FTS program will be automatically memorized.

NOTE

- You can program an FTS for a total of 100 discs. If you exceed that number, the least-frequently played FTS program(s) will be automatically deleted.

SETTINGS

In the settings menu, you can customize your player to suit your own particular requirements.

In Stop mode:

- Press SETUP to view the Settings screen.

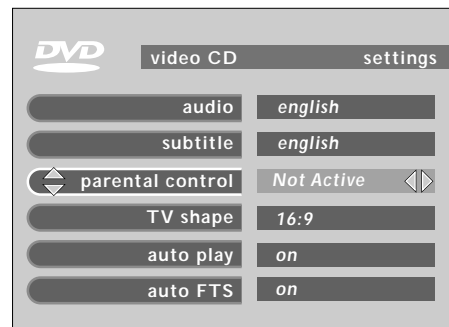

- Move to the function you want to change using then use to scroll to your preferred option.

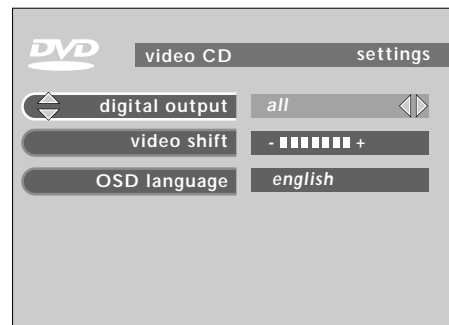

- To exit from the Settings menu, press RETURN or SETUP.

Audio

The sound will be in the language selected providing it is available on the disc being played. If not, speech will revert to the first spoken language on the disc.

Subtitle

The subtitling will be in the language selected providing it is available on the disc in play. If not, subtitling will revert to the first subtitling language on the disc.

Parental Control

Parental Control is described separately under 'Parental Control' p. 24.

TV Shape

Factory setting 16:9 (wide screen). If you have a regular (4:3) TV, you can choose Letterbox for a 'wide-screen' picture with black bars top and bottom, or Pan Scan, for a full-height picture with the sides trimmed. If a disc has Pan Scan, the picture then moves (scans) horizontally to keep the main action on the screen.

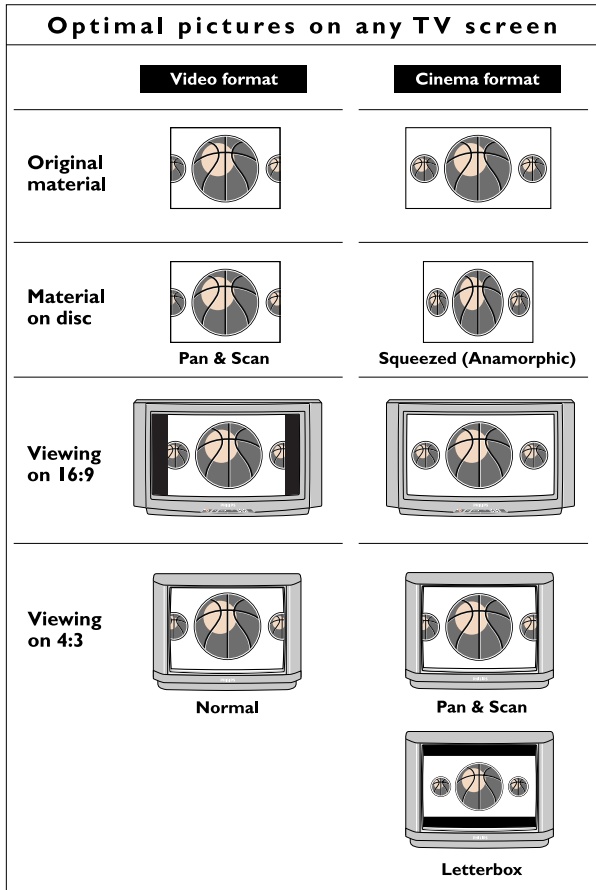

Auto Play

Factory setting ON means that discs start to play automatically when inserted. Change to OFF if you prefer to start play manually.

Auto FTS

Factory setting ON means that when a disc with an FTS program (see 'Compiling an FTS program p. 21) is inserted, the FTS program automatically starts to play. Change to OFF if you prefer to regulate FTS play manually.

Digital Output

Factory setting OFF means that there is no audio signal at the digital output. If you are connecting equipment with a digital input, change the setting to ALL.

If your equipment does not include a digital decoder, (e.g. digital speakers) set the digital output to PCM.

Video Shift

Factory setting centers the video image on your TV screen. Use this setting to personalize the position of the picture on your TV by scrolling it to the left or right.

OSD Language

The player's on-screen display will be in the language you choose.

PARENTAL CONTROL

PARENTAL CONTROL

ACTIVATING PARENTAL CONTROL

This can only be done in Stop mode

- 1 Press **SETUP** to view the Settings menu.
- 2 Move to Parental Control using **←** or **→**.
- 3 Press **OK** or **ENTER** to change Parental Control to Active.
- 4 You will be asked to enter a 4-digit PIN code of your own choice, and then to confirm your choice.
- 5 This code must then be entered to play any DVD Video or Video CD disc, unless you have previously authorized the disc as suitable for all ages.
- 6 To de-activate Parental Control repeat the above procedure.

AUTHORIZING DISCS

- 1 Insert the disc you wish to authorize and close the tray.
→ The OSD will ask for your PIN code.
- 2 Enter your PIN code.
- 3 Press **OK**.
- 4 Select Parental Control on the OSD by pressing **←**
→ The OSD will ask for your PIN code.
- 5 The disc is now authorized, and will play in the normal way, without the PIN code.

To cancel your authorization, repeat steps 4 and 5.

NOTE

- You can authorize a total of 50 discs. If you exceed that number, the least-frequently played disc(s) is (are) automatically de-authorized.

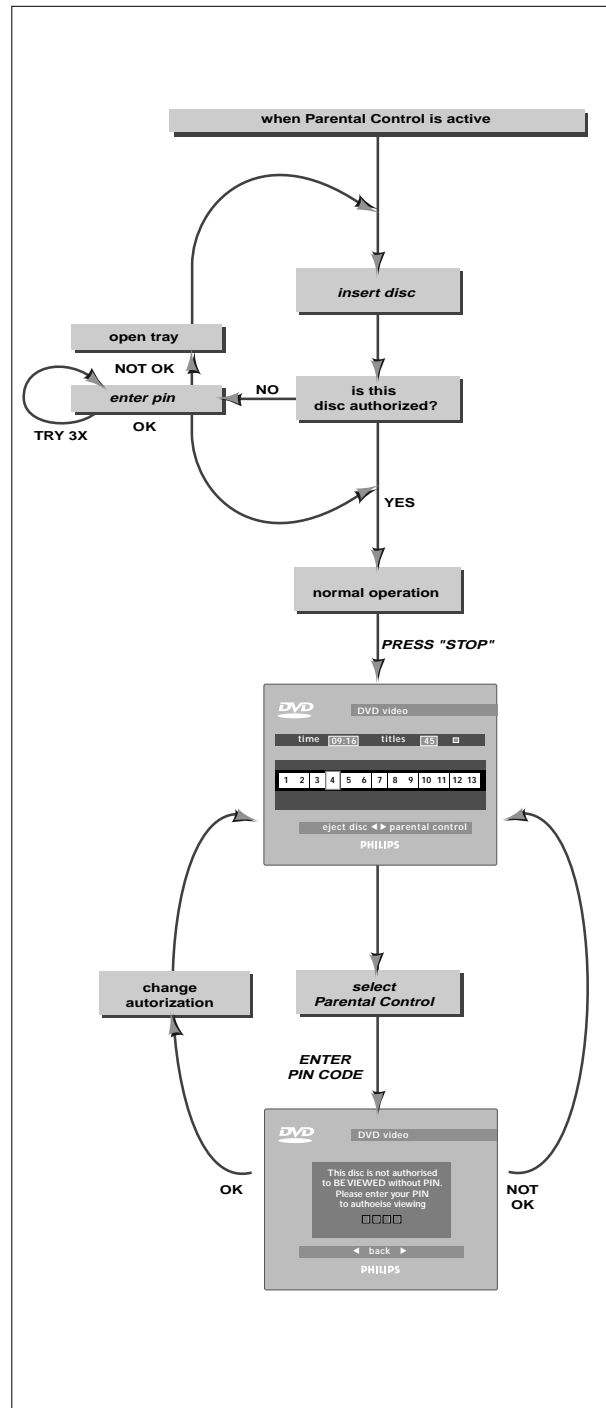

BEFORE REQUESTING SERVICE

BEFORE REQUESTING SERVICE

If the DVD-Video player appears to malfunction, first consult this checklist. Something simple may have been overlooked. Do not attempt to repair the system yourself under any circumstances; this will invalidate the warranty.

Look for the specific symptom(s). Then perform only the measures indicated in order to remedy the specific symptom(s).

SYMPTOM

- Remedy

NO POWER

- Make sure the on/off button on the front of the player is set to ON.
- Make sure both ends of the power cord are properly connected.
- Make sure there is power at the AC outlet by plugging in another appliance.

NO PICTURE

- Make sure the TV is switched on.
- Select the same channel and source on the TV as on the player.
- Check the video connection.

DISTORTED PICTURE

- Check the disc for fingerprints and clean it with a soft cloth, wiping from the center to the edge.
- Sometimes a small amount of picture distortion may occur. This is not a malfunction.

COMPLETELY DISTORTED PICTURE WITH PLAYER MENU

- NTSC/PAL switch in the wrong position.

NO COLOR IN THE PICTURE WITH PLAYER MENU

- NTSC/PAL switch in the wrong position.

DISC WILL NOT PLAY

- Make sure the disc label is facing upward.
- Clean the disc.
- Check if the disc is defective by trying another disc.

NO SOUND

- Check audio connections.
- If using a HiFi amplifier, try another sound source.

DISTORTED SOUND FROM HIFI AMPLIFIER

- Make sure the player's audio L/R output is not connected to the amplifier's phono input.

NO RETURN TO START-UP SCREEN WHEN DISC IS REMOVED

- Reset by switching the player off and then on again.
- Check to see if the program indicates that another disc should be loaded.

THE PLAYER DOES NOT RESPOND TO THE REMOTE CONTROL

- Aim the remote control directly at the sensor on the front of the player.
- Move any objects that could obstruct with the signal path.
- Inspect or replace the batteries.

DISTORTED OR BLACK AND WHITE PICTURE WITH DVD OR VIDEO CD DISC

- The disc format is not compatible with the type of TV set being used (NTSC/PAL).

NO AUDIO AT DIGITAL OUTPUT

- Check the digital connections.
- Check the settings menu to make sure that the digital output is set to ON.
- Check to make sure that the audio format of the selected audio language matches your receiver capabilities.

KEYS DO NOT WORK

- Reset by switching the player off, then on again.

CLEANING DISCS

Some problems can occur when the disc inside the player is dirty. To avoid such problems, clean your discs regularly with a soft cloth. Always wipe a disc from the center towards the edge.

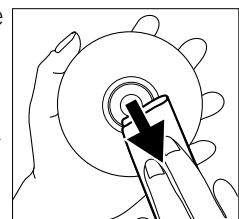

CAUTION

Do not use solvents such as benzene, thinner, commercially-available cleaners, or anti-static spray intended for analogue discs.



BEFORE REQUESTING SERVICE

DIAGNOSTIC PROGRAM

If the malfunction persists, you can run the player's Diagnostic Program.

INSTRUCTIONS:

- 1 Switch the player off.
- 2 Press down and hold both OPEN/CLOSE and **II** and turn the player on.
 - **'BUSY'** will appear on the display together with a counter. The counter indicates that the test has been completed when it reaches zero.
 - After a few minutes, **'BUSY'** changes to **'ERROR'** or **'PASS'**.
- 3 Switch the player off to exit from the Diagnostic Program.
- 4 **'ERROR'** indicates that your player needs repair. Contact your dealer or the Philips Consumer Information Center (CIC).
- 5 **'PASS'** indicates that the Diagnostic Program has found no errors. In this case, the malfunction may be a result of misinterpretation of the operating instructions, or could be caused by an unsuitable disc or incorrect connections. If you are unable to solve the problem, contact your dealer or the Philips CIC.
- 6 You will find the phone number of the Philips CIC in your Warranty Booklet.