

Register your product and get support at  
[www.philips.com/welcome](http://www.philips.com/welcome)

DS9000



---

EN User manual

---

ZH-CN 用户手册

---

**PHILIPS**

# Contents

---

<b>1 Important</b>	4
Safety	4
Notice	7

---

<b>2 Your Docking Entertainment System</b>	9
Introduction	9
What's in the box	9
Overview of the main unit	10
Overview of the remote control	11

---

<b>3 Get started</b>	13
Prepare the remote control	13
Connect power	14
Turn on	15

---

<b>4 Play</b>	16
Play from iPod/iPhone/iPad	16
Play from an external device	17
Adjust volume level	18
Mute sound	18

---

<b>5 Product information</b>	19
Specifications	19

---

<b>6 Troubleshooting</b>	20
--------------------------	----

# 1 Important

## Safety



This 'bolt of lightning' indicates uninsulated material within your unit may cause an electrical shock. For the safety of everyone in your household, please do not remove product covering.

The 'exclamation point' calls attention to features for which you should read the enclosed literature closely to prevent operating and maintenance problems.

**WARNING:** To reduce the risk of fire or electric shock, this apparatus should not be exposed to rain or moisture and objects filled with liquids, such as vases, should not be placed on this apparatus.

**CAUTION:** To prevent electric shock, match wide blade of plug to wide slot, fully insert.

- ① Read these instructions.
- ② Keep these instructions.
- ③ Heed all warnings.
- ④ Follow all instructions.

- ⑤ Do not use this apparatus near water.
- ⑥ Clean only with dry cloth.
- ⑦ Do not block any ventilation openings. Install in accordance with the manufacturer's instructions.
- ⑧ Do not install near any heat sources such as radiators, heat registers, stoves, or other apparatus (including amplifiers) that produce heat.
- ⑨ For countries with a polarized mains, do not defeat the safety purpose of the polarized or grounding-type plug. A polarized plug has two blades with one wider than the other. A grounding type plug has two blades and a third grounding prong. The wide blade or the third prong is provided for your safety. If the provided plug does not fit into your outlet, consult an electrician for replacement of the obsolete outlet.

Caution: To prevent electric shock, match the wide blade of the plug to the wide slot, fully insert.



- ⑩ Protect the power cord from being walked on or pinched, particularly at plugs, convenience receptacles, and the point where they exit from the apparatus.
- ⑪ Only use attachments/accessories specified by the manufacturer.
- ⑫ Use only with the cart, stand, tripod, bracket, or table specified by the manufacturer or sold with the apparatus. When a cart is used, use caution when moving the cart/apparatus combination to avoid injury from tip-over.



- ⑬ Unplug this apparatus during lightning storms or when unused for long periods of time.
- ⑭ Refer all servicing to qualified service personnel. Servicing is required when the apparatus has been damaged in any way, such as power-supply cord or plug is damaged, liquid has been spilled or objects have fallen into the apparatus, the apparatus has been exposed to rain or moisture, does not operate normally, or has been dropped.
- ⑮ Battery usage **CAUTION** – To prevent battery leakage which may result in bodily injury, property damage, or damage to the unit:
- Install all batteries correctly, + and - as marked on the unit.
  - Remove batteries when the unit is not used for a long time.
  - The batteries shall not be exposed to excessive heat such as sunshine, fire or the like.
- ⑯ Apparatus shall not be exposed to dripping or splashing.
- ⑰ Do not place any sources of danger on the apparatus (e.g. liquid filled objects, lighted candles).



#### Warning

- Where the MAINS plug or an appliance coupler is used as the disconnect device, the disconnect device shall remain readily operable.



## Warnings

- Never remove the casing of this apparatus.
- Never lubricate any part of this apparatus.
- Never place this apparatus on other electrical equipment.
- Keep this apparatus away from direct sunlight, naked flames or heat.
- Ensure that you always have easy access to the power cord, plug or adaptor to disconnect the apparatus from the power.

---

## Notice

Any changes or modifications made to this device that are not expressly approved by Philips Consumer Lifestyle may void the user's authority to operate the equipment.

### Environmental information

All unnecessary packaging has been omitted. We have tried to make the packaging easy to separate into three materials: cardboard (box), polystyrene foam (buffer) and polyethylene (bags, protective foam sheet.)

Your system consists of materials which can be recycled and reused if disassembled by a specialized company. Please observe the local regulations regarding the disposal of packaging materials, exhausted batteries and old equipment.

Made for



iPod



iPhone



iPad

“Made for iPod, iPhone and iPad” means that an electronic accessory has been designed to connect specifically to iPod, iPhone and iPad and has been certified by the developer to meet Apple performance standards.

Apple is not responsible for the operation of this device or its compliance with safety and regulatory standards.

Please note that the use of this accessory with iPod, iPhone or iPad may affect wireless performance.

iPod is a trademark of Apple Inc., registered in the U.S. and other countries.



#### Note

- The type plate is located on the bottom of the apparatus.

## 2 Your Docking Entertainment System

Congratulations on your purchase, and welcome to Philips! To fully benefit from the support that Philips offers, register your product at [www.philips.com/welcome](http://www.philips.com/welcome).

---

### Introduction

With this unit, you can enjoy audio from the iPod/iPhone/iPad and other audio devices.

---

### What's in the box

Check and identify the contents of your package:

- Main unit
- Remote control
- 1 x AC power cord
- 1 x MP3 link cable
- User manual



---

# Overview of the main unit

## Front View

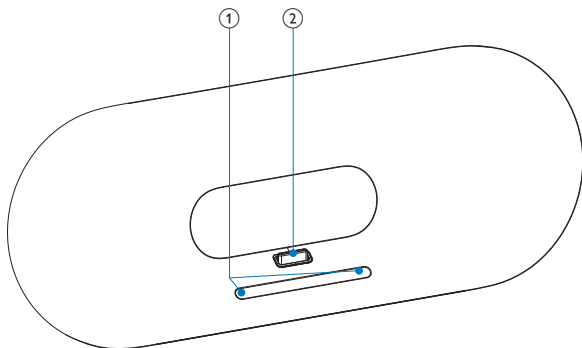

- ① - VOL +
  - Adjust volume.
- ② iPod/iPhone/iPad dock

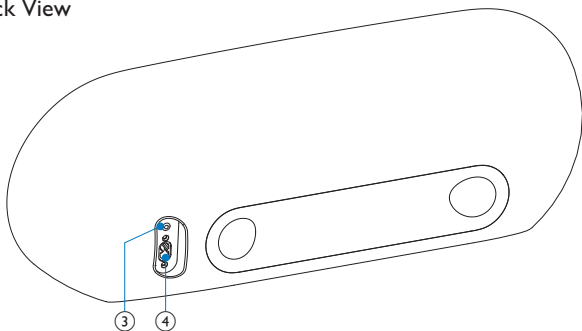

## Back View

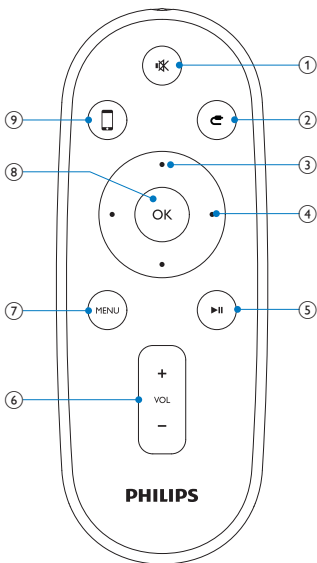

- ③ **AUX IN**
  - Jack for an external audio device.
- ④ **Power supply socket**

## Overview of the remote control



- 1 
  - Mute or restore volume.
- 2 
  - Select the MP3 link mode.
- 3 **Up/down keys**
  - Navigate through the iPod/iPhone/iPad menu.

- 4 Fast forward/backward keys**
  - Fast reverse or fast forward within a track.
  - Skip to the previous/next track.
- 5 ►||**
  - Start or pause play.
- 6 VOL +/-**
  - Adjust volume.
- 7 MENU**
  - Access the iPod/iPhone/iPad menu.
- 8 OK**
  - Confirm a selection.
- 9 □**
  - Select the iPod/iPhone/iPad dock mode

# 3 Get started



## Caution

- Use of controls or adjustments or performance of procedures other than herein may result in hazardous radiation exposure or other unsafe operation.

Always follow the instructions in this chapter in sequence. If you contact Philips, you will be asked for the model and serial number of this apparatus. The model number and serial number are on the bottom of the apparatus. Write the numbers here:

Model No. \_\_\_\_\_

Serial No. \_\_\_\_\_

---

## Prepare the remote control



## Caution

- Risk of explosion! Keep batteries away from heat, sunshine or fire. Never discard batteries in fire.

### For first-time use:

- 1 Remove the protective tab to activate the remote control battery.

### To replace the remote control battery:

- 1 Open the battery compartment.
- 2 Insert one CR2032 battery with correct polarity (+/-) as indicated.

### 3 Close the battery compartment.

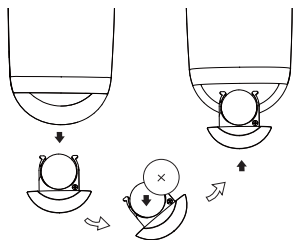

#### Notes

- Before pressing any function button on the remote control, first select the correct source with the remote control instead of the main unit.
- If you are not going to use the remote control for a long time, remove the battery.

---

## Connect power



#### Cautions

- Risk of product damage! Ensure that the power supply voltage corresponds to the voltage printed on the bottom of the unit.
- Risk of electric shock! When you unplug the AC power cord, always pull the plug from the socket. Never pull the cord.
- Before connecting the AC power cord, ensure you have completed all other connections.

- 1 Connect the AC power cord to the wall outlet.

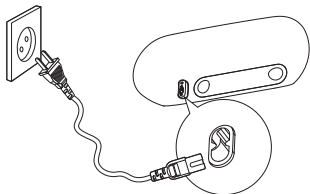

---

## Turn on

- 1 The unit turns on automatically after power connection.
  - ↳ When the user approaches the unit, the LED light under the volume button on the main unit turns on automatically.

---

## Switch to Eco Power Standby

The unit switches to the Eco Power Standby mode automatically when:

- the iPod/iPhone/iPad is disconnected from the unit in the dock mode.
- the connected device stops music play for more than 15 minutes in the MP3 link mode.

# 4 Play

---

## Play from iPod/iPhone/iPad

You can enjoy audio from iPod/iPhone/iPad through this unit.

---

### Compatible iPod/iPhone/iPad

Apple iPod,iPhone and iPad models with a 30-pin dock connector:

Made for:

- iPod nano (2nd generation)
- iPod nano (3rd generation)
- iPod nano (4th generation)
- iPod classic
- iPod touch (1st generation)
- iPod touch (2nd generation)

Works with

- iPhone
  - iPhone 3G
  - iPhone 3GS
  - iPad
  - iPhone4
- 

### Load the iPod/iPhone/iPad

- 1 Place the iPod/iPhone/iPad in the dock.

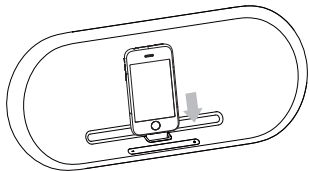

## To remove the iPod/iPhone/iPad

- 1 Pull the iPod/iPhone/iPad out of the dock.

---

## Listen to the iPod/iPhone/iPad

- 1 Ensure that the iPod/iPhone/iPad has been loaded correctly.
- 2 Press **□** to select the dock mode.
- 3 Press **▶||**.
  - ↳ The connected iPod/iPhone/iPad starts to play.
    - To pause/resume play, press **▶||**.
    - To skip to a track, press the fast forward/backward keys.
    - To search during play, press and hold the fast forward/backward keys, then release to resume normal play.
    - To navigate through the menu, press **MENU**, then press the up/down keys to select, and press **OK** to confirm.

---

## Charge the iPod/iPhone/iPad

The docked iPod/iPhone/iPad begins to charge as soon as the unit is connected to AC power.

---

## Play from an external device

You can also listen to an external audio device through this unit.

- 1 Press **Ⓞ** to select the MP3 link mode.
- 2 Connect the supplied MP3 link cable to:
  - the **AUX IN** jack (3.5mm) on the back of the unit.
  - the headphone jack on an external device.
- 3 Start to play the device (see the device user manual).



---

## Adjust volume level

- 1 During play, press **VOL +/-** to increase/decrease the volume level.

---

## Mute sound

- 1 During play, press **MUTE** to mute/unmute sound.

# 5 Product information



## Note

- Product information is subject to change without prior notice.

---

## Specifications

### Amplifier

Rated Output Power	2X50 W RMS
Signal to Noise Ratio	85 dB
MP3 Link	0.6 V RMS 10 kohm

---

### General information

AC power	100-240V~, 50/60Hz
Operation Power Consumption	<35W
Eco Standby Power Consumption	<1W
Dimensions	
- Main Unit (W x H x D)	562 x 219 x 180 mm
Weight	
- Main Unit	6.4 kg

# 6 Troubleshooting



## Warning

- Never remove the casing of this apparatus.

To keep the warranty valid, never try to repair the system yourself. If you encounter problems when using this apparatus, check the following points before requesting service. If the problem remains unsolved, go to the Philips web site ([www.philips.com/welcome](http://www.philips.com/welcome)). When you contact Philips, ensure that the apparatus is nearby and the model number and serial number are available.

### No power

- Ensure that the AC power plug of the unit is connected properly.
- Ensure that there is power at the AC outlet.

### No sound

- Adjust the volume.

### No response from the unit

- Disconnect and reconnect the AC power plug, then turn on the unit again.



© 2010 Koninklijke Philips Electronics N.V.

All rights reserved.

DS9000\_97\_UM\_V1.0

