

Register your product and get support at

www.philips.com/welcome

DS3120



EN User manual

PHILIPS

Contents

1	Important	3
<hr/>		
2	Your Docking Speaker	4
	Introduction	4
	What's in the box	4
	Overview of the main unit	4
<hr/>		
3	Get started	5
	Connect power	5
	Turn on	6
<hr/>		
4	Play	6
	Play from iPod/iPhone	6
	Play from an external device	8
	Adjust volume	9
<hr/>		
5	Specifications	9
	Amplifier	9
	General information	9
<hr/>		
6	Troubleshooting	10
<hr/>		
7	Notice	10

1 Important

- Read these instructions.
- Heed all warnings.
- Follow all instructions.
- Do not use this apparatus near water.
- Do not block any ventilation openings. Install in accordance with the manufacturer's instructions.
- Do not install near any heat sources such as radiators, heat registers, stoves, or other apparatus (including amplifiers) that produce heat.
- Protect the power cord from being walked on or pinched, particularly at plugs, convenience receptacles, and the point where they exit from the apparatus.
- Only use attachments/accessories specified by the manufacturer.
- Unplug this apparatus during lightning storms or when unused for long periods of time.
- Refer all servicing to qualified service personnel. Servicing is required when the apparatus has been damaged in any way, such as power-supply cord or plug is damaged, liquid has been spilled or objects have fallen into the apparatus, the apparatus has been exposed to rain or moisture, does not operate normally, or has been dropped.
- The battery shall not be exposed to excessive heat such as sunshine, fire or the like.
- Apparatus shall not be exposed to dripping or splashing.
- Do not place any sources of danger on the apparatus (e.g. liquid filled objects, lighted candles).
- The USB socket is for data transmission only.
- Where the plug of the Direct Plug-in Adapter is used as the disconnect device, the disconnect device shall remain readily operable.



Warning

- Never remove the casing of this apparatus.
- Never place this apparatus on other electrical equipment.
- Ensure that you always have easy access to the power cord, plug or adaptor to disconnect the apparatus from the power.

Always bring your product to a professional to remove the built-in battery.

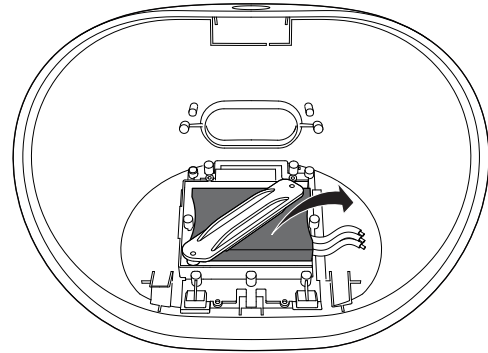

2 Your Docking Speaker

Congratulations on your purchase, and welcome to Philips! To fully benefit from the support that Philips offers, register your product at www.philips.com/welcome.

Introduction

With this docking speaker, you can

- enjoy audio from the iPod/iPhone, and other external audio devices; and
- synchronize the iPod/iPhone with your computer through USB socket.

What's in the box

Check and identify the contents of your package:

- Main unit
- AC power adaptor
- Quick start guide

Overview of the main unit

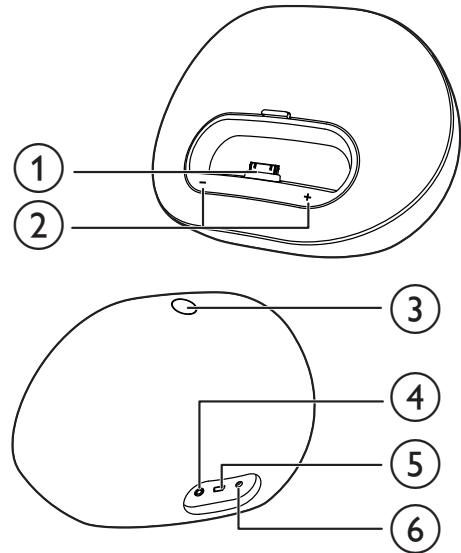

- ① **Dock for the iPod/iPhone**
- ② **+ / -**
 - Adjust volume.
 - As LED indicators, show system status.
- ③ **⏻**
 - Turn the docking speaker on or off.
- ④ **Power supply socket**
 - Connect AC power.
- ⑤ **🔌**
 - Connect a computer with a USB cable.
- ⑥ **MP3-LINK**
 - Connect an external audio device.

3 Get started

Always follow the instructions in this chapter in sequence.

Connect power

! Caution

- Risk of product damage! Make sure that the power supply voltage matches the voltage printed on the bottom of the unit.
- Risk of electric shock! When you unplug the AC adaptor, always pull the plug from the socket. Never pull the cord.

☰ Note

- The type plate is located at the back of the unit.

Connect the AC power adaptor to:

- the power socket at the back of the docking speaker.
- the wall socket.

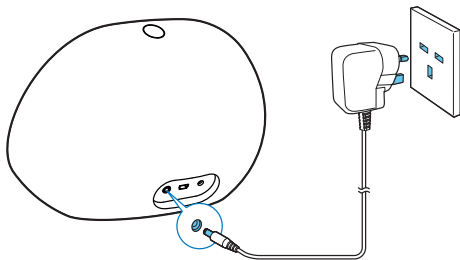

Built-in Battery

! Caution

- Danger of explosion if battery is incorrectly replaced. Replace only with the same or equivalent type.

The docking speaker can also operate on the built-in rechargeable battery.

Battery power LED indicator

Battery power	LED indicator
Low	Flashing
Full	Steadily on
Empty	Off

To recharge the built-in battery:

- Connect the docking speaker to the power supply.
 - ↳ In standby mode, the LED indicators are off.

☰ Note

- Use the supplied AC adaptor only to charge the battery.

Turn on

Press \odot to turn the docking speaker on.
↳ The + / - LED indicators light up.

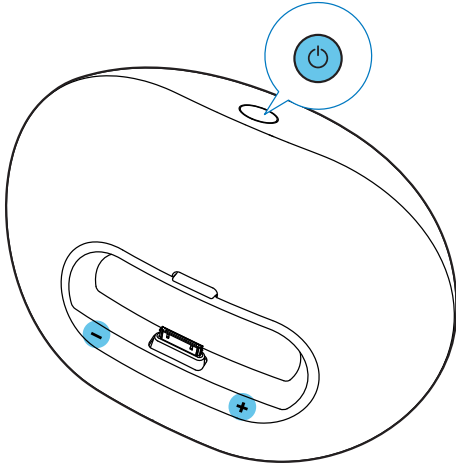

Switch to standby mode

The docking speaker switches to standby mode in the following situation:

- Press \odot again;
 - In AC power supply, the speaker is idle for 15 minutes; or
 - In battery power supply, the iPod/iPhone or external audio device is disconnected from the speaker.
- ↳ In standby mode, the + / - LED indicators are off.

4 Play

Play from iPod/iPhone

You can enjoy audio from your iPod/iPhone through this docking speaker.

Compatible iPod/iPhone

The docking speaker supports the following iPod and iPhone models:

Made for:

- iPod touch (1st, 2nd, 3rd, and 4th generation)
- iPod classic
- iPod nano (1st, 2nd, 3rd, 4th, 5th, and 6th generation)
- iPhone 4S
- iPhone 4
- iPhone 3GS
- iPhone 3G
- iPhone

Listen to the iPod/iPhone

To enjoy more features, you are recommended to install the free **DockStudio** app.

- 1 Press \odot to turn the docking speaker on.
↳ The LED indicators light up.
- 2 Insert the iPod/iPhone into the dock.

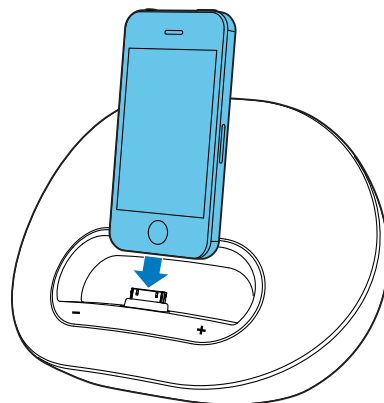

- 3 For first-time use, you will be asked to install **DockStudio** app on your iPod/iPhone.
- 4 Tap **[Yes]** (yes) to accept the installation request.
- 5 Follow the on-screen instructions to complete the installation.



- 6 Launch the app after the installation.
- 7 Play audio on your iPod/iPhone.
 - ↳ Audio comes out through this docking speaker.

Note

- With the **DockStudio** app, you can enjoy music, set clock and alarm, adjust sound settings, and update firmware if necessary.

Update firmware

If firmware update is available, the **DockStudio** app will search for it automatically and ask you to download it.

Note

- Make sure that your iPod/iPhone is inserted in the docking speaker and connected to the Internet.

- 1 If a new firmware update is found, tap **OK**.



- 2 Follow the on-screen instructions to complete the firmware update.





Note

- Do not disconnect power or undock the iPod/iPhone during the updating process.

Charge the iPod/iPhone

Note

- If the docking speaker is operated on the batteries, you cannot charge your iPod/iPhone.

When the docking speaker is connected to AC power, the docked iPod/iPhone begins to charge.

Tip

- For certain iPod models, it may take up to a minute before the charging indication appears.

Sync iPod/iPhone with PC

Note

- Make sure that iTunes has been configured properly in your PC.

- 1 Insert the iPod/iPhone in the dock.
- 2 Press ⏻ to switch to standby mode.
↳ The LED indicators light off.
- 3 Connect your docking speaker and PC with a USB cable.
- 4 Launch iTunes to synchronize your docking speaker with PC.
↳ The docked iPod/iPhone is synchronized with PC successfully through the iTunes.

Note

- Due to different materials and product techniques, some USB cables may not work with this device.

Play from an external device

With this docking speaker, you can also enjoy audio from an external device such as an MP3 player:

Note

- Make sure that no iPod/iPhone is docked in the speaker.

- 1 Press ⏻ to turn the docking speaker on.
- 2 Connect the MP3 link cable (not supplied) to:
 - the **MP3-LINK** socket at the back of the docking speaker.
 - the headphone socket on an external device.↳ The docking speaker switches to MP3 link mode automatically.
- 3 Play audio on the device (see the device's user manual).

Adjust volume

To adjust volume:

- Press +/- on your docking speaker; or
- Adjust the volume control of your iPod/iPhone or external device.

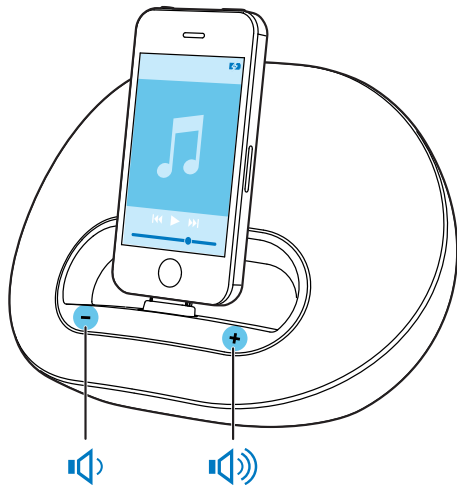

Tip

- If the docking speaker is powered by batteries, the volume is lower than that by AC supply.

5 Specifications

Note

- Product information is subject to change without prior notice.

Amplifier

Rated Output Power 2 X 5 W RMS

General information

Power supply	Model: AS190-090-
- AC Power	AI190 (Philips);
	Input: 100-240 V ~,
	50/60Hz, 0.7A;
	Output: 9 V \equiv 1.9 A
- Battery	Li-ion battery
Operation Power	
Consumption	<10 W
Standby Power	
Consumption	<0.5 W
Max. load for iPod/ iPhone	5 V \equiv 1 A
Dimensions	
- Main Unit	
(W x H x D)	224 x 162 x 120 mm
Weight	
- Main Unit	1.1 kg
- With Packing	1.6 kg

6 Troubleshooting



Warning

- Never remove the casing of this apparatus.

To keep the warranty valid, never try to repair the system yourself.

If you encounter problems when using this apparatus, check the following points before requesting service. If the problem remains unsolved, go to the Philips web site (www.philips.com/support). When you contact Philips, ensure that the apparatus is nearby and the model number and serial number are available.

No power

- Make sure that the AC power adaptor of the device is connected properly.
- Make sure that there is power at the AC outlet.

No sound or poor sound

- Adjust the volume of your docking speaker.
- Adjust the volume of your iPod/iPhone or external audio device.

No response from the unit

- Disconnect and reconnect the AC power plug, and then switch on the device again.

Cannot sync with PC

- Switch the docking speaker to standby mode.
- Try another USB cable.
- Install iTunes in PC properly.

7 Notice

Any changes or modifications made to this device that are not expressly approved by Philips Consumer Lifestyle may void the user's authority to operate the equipment.

Made for



iPod



iPhone

“Made for iPod” and “Made for iPhone” mean that an electronic accessory has been designed to connect specifically to iPod or iPhone respectively, and has been certified by the developer to meet Apple performance standards. Apple is not responsible for the operation of this device or its compliance with safety and regulatory standards. Please note that the use of this accessory with iPod or iPhone may affect wireless performance. iPod and iPhone are trademarks of Apple Inc., registered in the U.S. and other countries.



This product complies with the radio interference requirements of the European Community.



Your product is designed and manufactured with high quality materials and components, which can be recycled and reused.



When this crossed-out wheeled bin symbol is attached to a product it means that the product

is covered by the European Directive 2002/96/EC.

Please inform yourself about the local separate collection system for electrical and electronic products.

Please act according to your local rules and do not dispose of your old products with your normal household waste. Correct disposal of your old product helps to prevent potential negative consequences for the environment and human health.



Your product contains batteries covered by the European Directive 2006/66/EC, which cannot be disposed with normal household waste. Please inform yourself about the local rules on separate collection of batteries because correct disposal helps to prevent negative consequences for the environmental and human health.

Environmental information

All unnecessary packaging has been omitted. We have tried to make the packaging easy to separate into three materials: cardboard (box), polystyrene foam (buffer) and polyethylene (bags, protective foam sheet.)

Your system consists of materials which can be recycled and reused if disassembled by a specialized company. Please observe the local regulations regarding the disposal of packaging materials, exhausted batteries and old equipment.

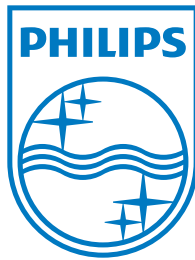

Specifications are subject to change without notice
© 2012 Koninklijke Philips Electronics N.V.
All rights reserved.

DS3120_05_UM_V1.0

