

Always there to help you

Register your product and get support at www.philips.com/welcome



DS1600

Short User Manual



2013 © WOOX Innovations Limited. All rights reserved. Philips and the Philips' Shield Emblem are registered trademarks of Koninklijke Philips N.V. and are used by WOOX Innovations Limited under license from Koninklijke Philips N.V. DS1600_05_SUM_V1.0



Important

Safety

Only use attachments/accessories specified by the manufacturer. Use only power supplies listed in the user manual. The product shall not be exposed to dripping or splashing. Do not place any sources of danger on the product (e.g. liquid filled objects, lighted candles). Where the plug of the Direct Plug-in Adapter is used as the disconnect device, the disconnect device shall remain readily operable.

Warning

- Never remove the casing of this apparatus.
- Never lubricate any part of this apparatus.
- Never place this apparatus on other electrical equipment.
- Keep this apparatus away from direct sunlight, naked flames or heat.
- Make sure that you always have easy access to the power cord, plug, or adaptor to disconnect the apparatus from the power.

Notice

Any changes or modifications made to this device that are not expressly approved by WOOX Innovations may void the user's authority to operate the equipment.



This product complies with the radio interference requirements of the European Community.



Your product is designed and manufactured with high quality materials and components, which can be recycled and reused.



When this crossed-out wheeled bin symbol is attached to a product it means that the product is covered by the European Directive 2002/96/EC. Please inform yourself about the local separate collection system for electrical and electronic products.

Please act according to your local rules and do not dispose of your old products with your normal household waste. Correct disposal of your old product helps to prevent potential negative consequences for the environment and human health.

Environmental information

All unnecessary packaging has been omitted. We have tried to make the packaging easy to separate into three materials: cardboard (box), polystyrene foam (buffer) and polyethylene (bags, protective foam sheet). Your system consists of materials which can be recycled and reused if disassembled by a specialized company. Please observe the local regulations regarding the disposal of packaging materials, exhausted batteries and old equipment.

Be responsible Respect copyrights

The making of unauthorized copies of copy-protected material, including computer programs, files, broadcasts and sound recordings, may be an infringement of copyrights and constitute a criminal offence. This equipment should not be used for such purposes.



"Made for iPod," "Made for iPhone," and "Made for iPad" mean that an electronic accessory has been designed to connect specifically to iPod, iPhone, or iPad, respectively, and has been certified by the developer to meet Apple performance standards. Apple is not responsible for the operation of this device or its compliance with safety and regulatory standards. Please note that the use of this accessory with iPod, iPhone, or iPad may affect wireless performance.

iPod and iPhone are trademarks of Apple Inc., registered in the U.S. and other countries. iPad is a trademark of Apple Inc.

Class II equipment symbol:



CLASS II apparatus with double insulation, and no protective earth provided.

Note

- The type plate is located on the bottom of the apparatus.

Amplifier

Rated Output Power	2 x 2.5 W RMS
Signal to Noise Ratio	> 55 dBA
MP3 Link Input	650mV RMS

General information

AC/DC switching adapter	Model: AS250-050-AI400 Input: 100-240 V~, 50/60 Hz, 1.2 A; Output: 5 V === 4 A;
Operation Power Consumption	< 23 W
Standby Power Consumption	< 1 W
USB Charging	DC 5 V === ≤ 1000 mA
iPod/iPhone Charging	DC 5 V === ≤ 2100 mA
Dimensions: - Main Unit (W x H x D)	225 x 149 x 96 mm
Weight: - Main Unit	0.83 kg

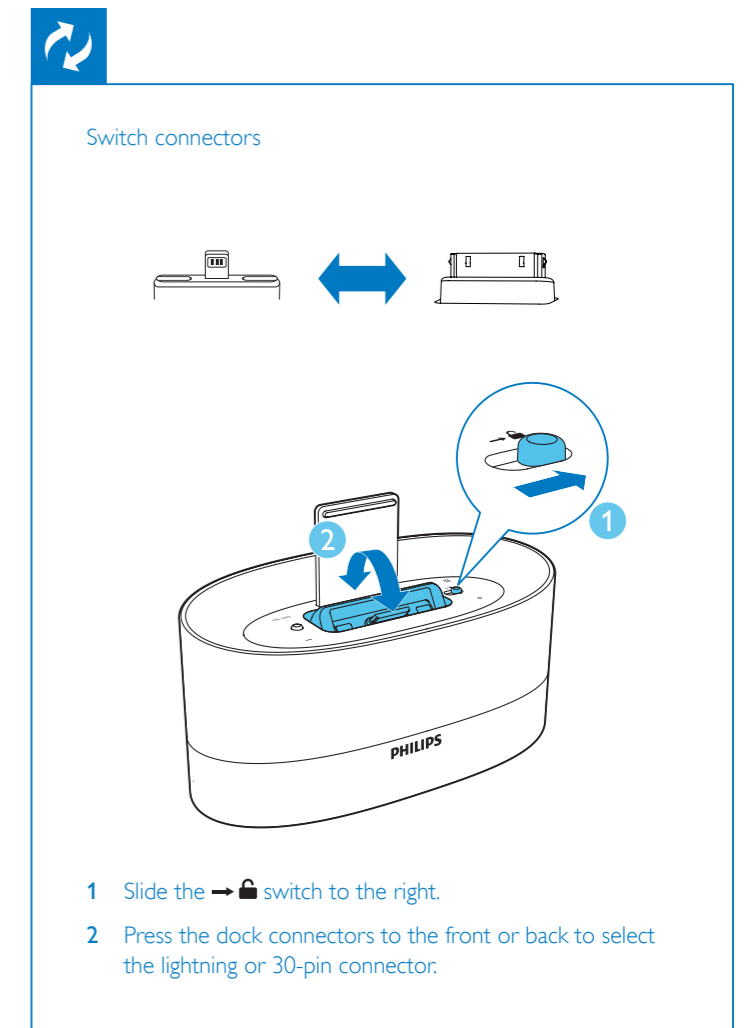
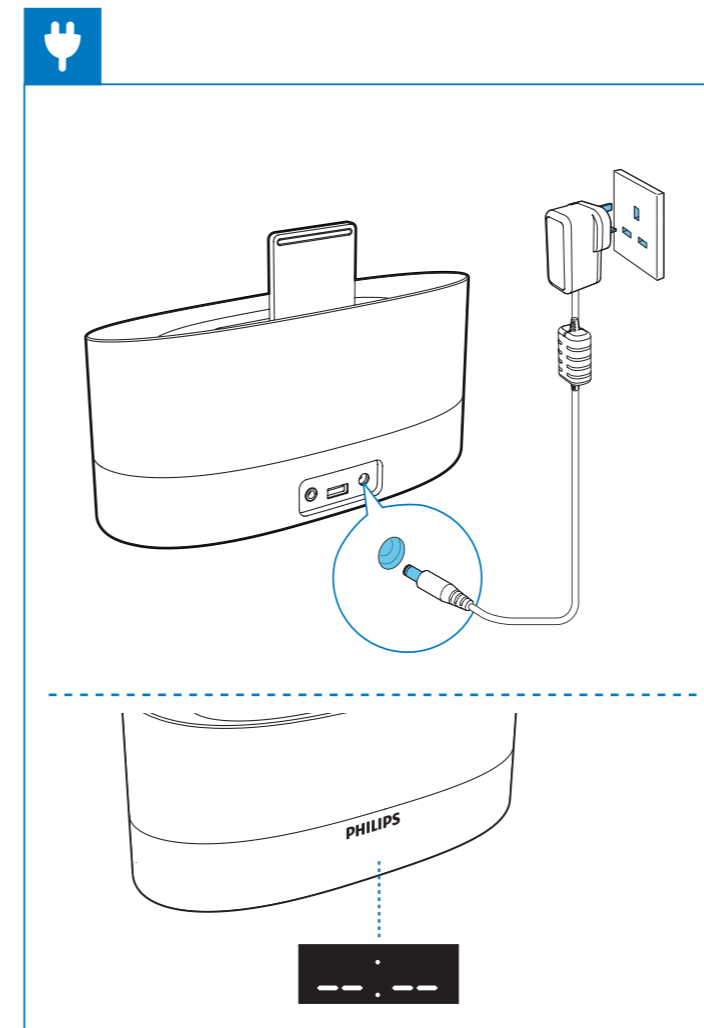
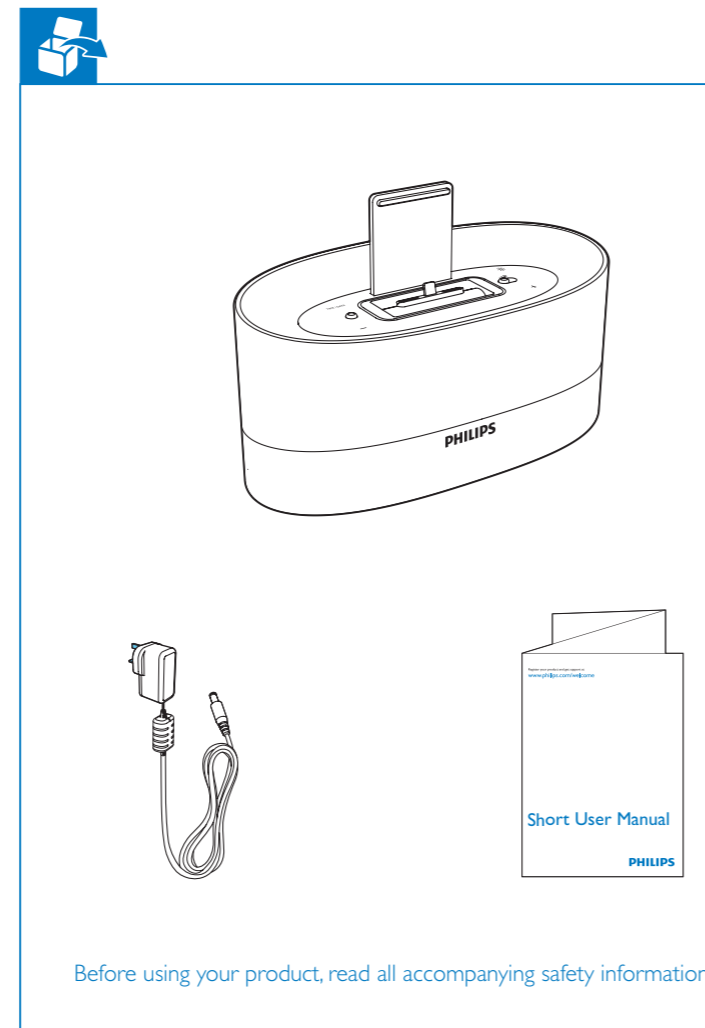

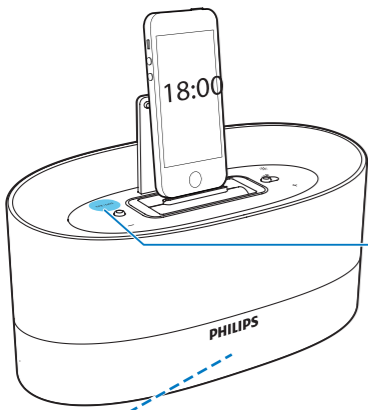
TIME / DATE

TIME / DATE 3 sec

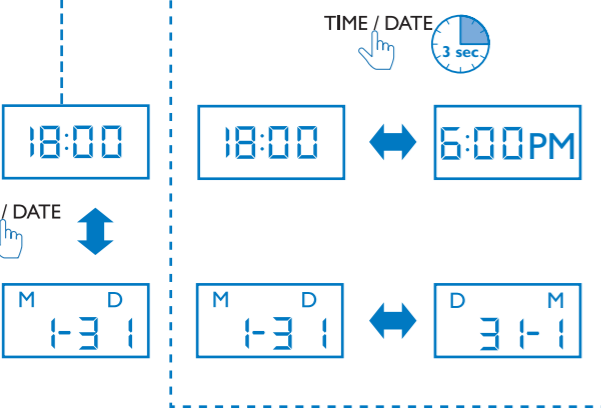
TIME / DATE

M D 1-3 1 M D 1-3 1 D M 3-1

18:00

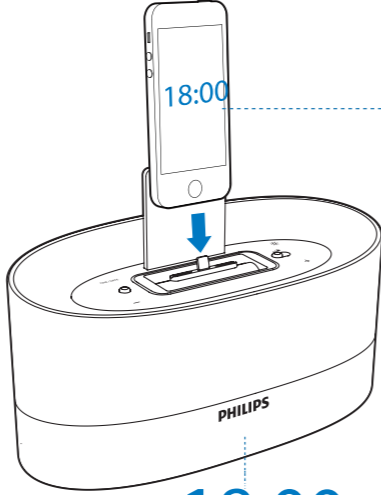
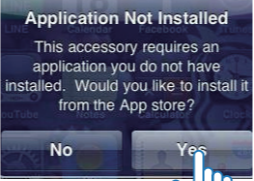
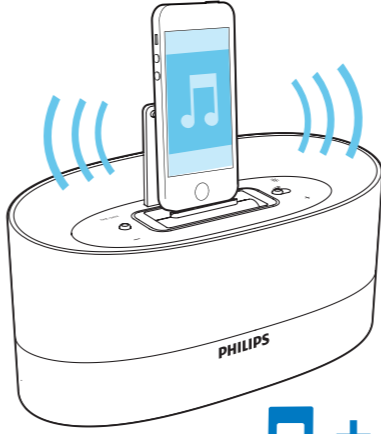

Follow the on-screen instructions to complete the installation.

The docking speaker automatically synchronizes the clock or date with your iPod/iPhone/iPad when docked.

✓ iPod nano 7th Generation
iPod touch 5th Generation
iPhone 5
iPad mini
iPad 4

iPod classic
iPod touch (2nd, 3rd, 4th Generation)
iPod nano (1st, 2nd, 3rd, 4th, 5th, 6th Generation)
iPod with video, iPod with color display
iPod mini
iPhone 3G, iPhone 3GS, iPhone4, iPhone 4S
iPad 1, iPad 2, new iPad

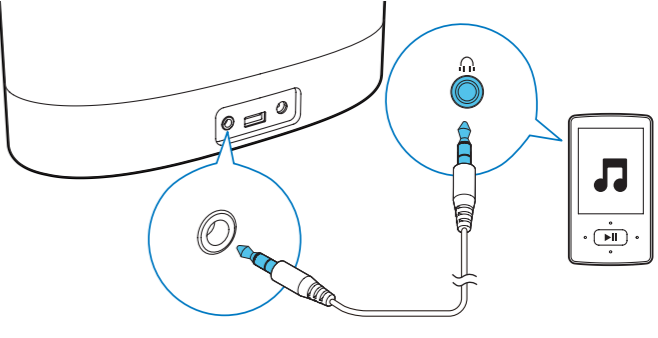
🎵 + ⚡

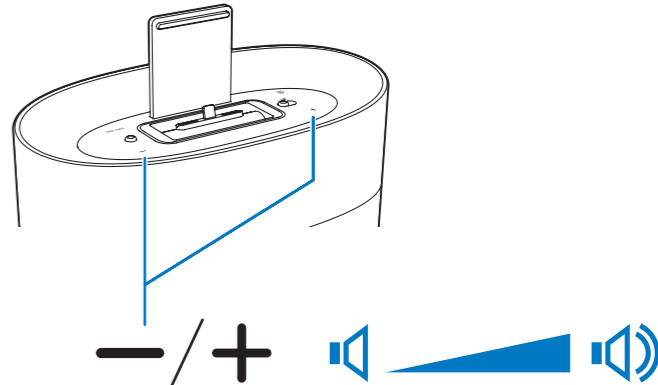

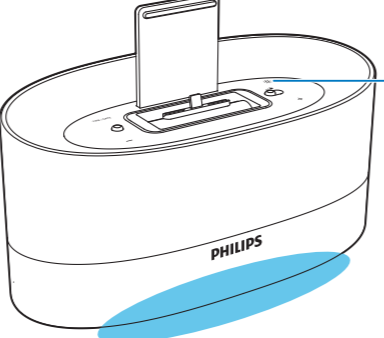
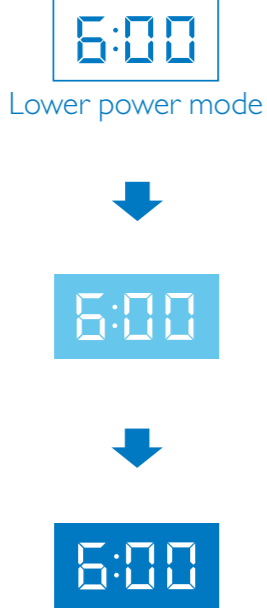

- / +

6:00
Lower power mode

6:00

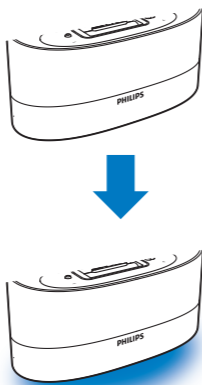
6:00

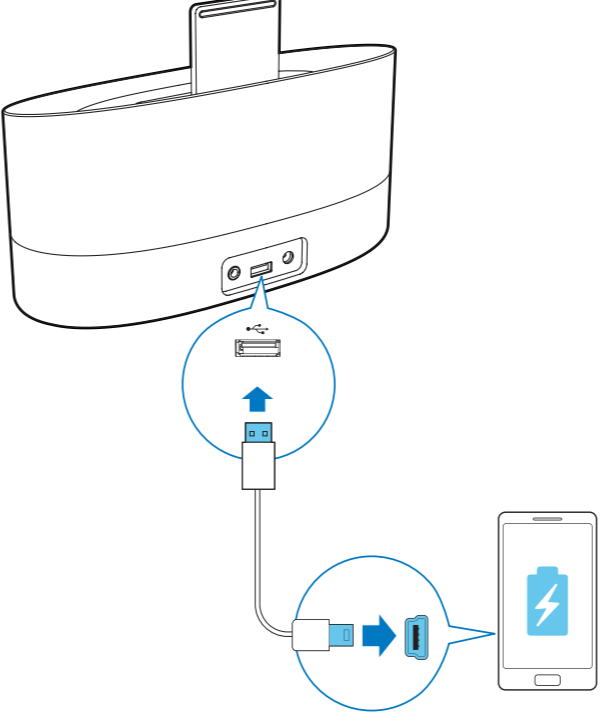
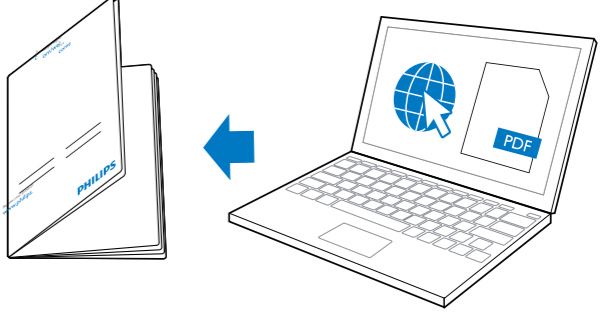
To get the detailed instructions for use, visit www.philips.com/welcome.