

# PHILIPS

Philips body analysis scale with Bluetooth® Smart  
DL8781, DL8780



EN-US



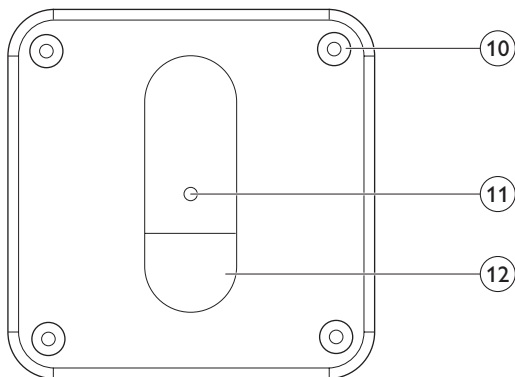
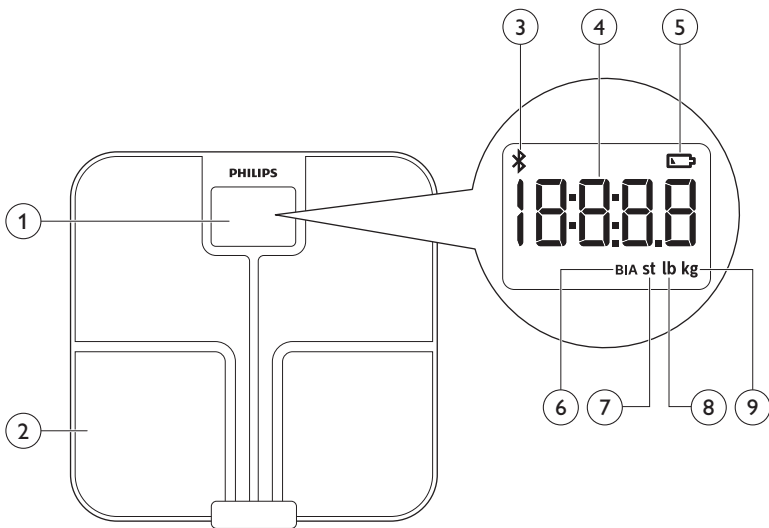



## English 6

# Contents

Introduction	7
General	7
Explanation of symbols	8
General description (Fig. 1)	9
Intended use	9
IMPORTANT SAFEGUARDS	9
Contraindications	9
Warnings	10
Caution	10
SAVE THESE INSTRUCTIONS	11
Compliance with standards	11
Using the body analysis scale	11
Preparing for use	11
Inserting/removing the batteries	11
Placing the carpet feet	12
Setting the measurement unit	13
Pairing the body analysis scale to your mobile device and create a user profile	13
Measuring weight and body fat	14
Tips for proper measurement	14
Performing a measurement	15
Performing a measurement with app	15
Performing a measurement without app	16
Factory reset	17
Cleaning and storage	18
Accessories	18
Disposal	18
Assistance	18
Full Two-Year Warranty	19
Troubleshooting	19
Specifications	21
Electromagnetic emissions and immunity	22
EMC Guidance	22
Table 1 Guidance and manufacturer's declaration – electromagnetic emissions - for all ME equipment and ME systems	22
Table 2 Guidance and manufacturer's declaration – electromagnetic immunity – for all ME equipment and ME systems	23
Table 4 Guidance and manufacturer's declaration – electromagnetic immunity –for ME equipment and ME systems that are not life supporting	23
Table 6 Recommended separation distances between portable and mobile RF communications equipment and the ME equipment or ME system – for ME equipment and ME systems that are not life supporting	24
FCC Compliance information	25
Radio interference	25
RF Radiation exposure statement	25
Bluetooth wordmark	26
App Store and iPhone	26
Google Play and Android	26

# Introduction

Congratulations on your purchase and welcome to Philips!  
To fully benefit from the support that Philips offers, register your product at [www.philips.com/welcome](http://www.philips.com/welcome).

## General

This Philips body analysis scale offers you a convenient tool to measure your weight.

The scale enables you to perform a body weight and fat measurement. It also transmits data via Bluetooth® Smart to your mobile device and to calculate and display weight, BMI and body fat percentage in the Philips HealthSuite health app. The scale has a maximum weighing capacity of 28 st 5 lb (397 lb) / 180 kg.

Note: Only weight measurement is displayed on the scale. BMI and body fat percentage are only shown in the app.

This user manual contains important safety information and provides step-by-step instructions for using the device.

Read this information carefully before you use the device and save it for future reference.

Features:

- Memory for up to 40 measurements per user for 8 separate users.
- Measures body fat with BIA (bioelectrical impedance analysis) technology.
- User recognition based on weight.
- Automatic activation of the scale when you step on it thanks to the Sense-On technology.
- LCD display.

## Explanation of symbols

The warning signs and symbols are essential to ensure that you use this product safely and correctly and to protect you and others from injury. Following is the meaning of the warning signs and symbols on the label and in the user manual.



Symbol indicates the need for the user to consult the instructions for use



Type BF applied part



Indicates the need for the user to consult the instructions for use for important cautionary information such as warnings and precautions that cannot, for a variety of reasons, be presented on the medical device itself.



This symbol means that this device emits nonionizing radiation. All devices with RF transmitters or that use RF electromagnetic energy must have a label with this symbol.



Indicates the manufacturer's serial number so that a specific device can be identified.



Symbol for the 2 year Philips warranty.



Indicates manufacturer's catalog number of the appliance.



For indoor use only.



Indicates manufacturing date



Indicates the temperature limits to which the device can be safely exposed: -4°F to 140°F / -20°C to 60°C.

IP22

This symbol on the device means: protected against access to hazardous parts with a finger and against vertically falling water drops when tilted up to 15 degrees.



Indicates the relative humidity limits to which the device can be safely exposed: 10% to 93%.



Symbol for the 'Bluetooth Combination mark'. The device uses Bluetooth for communication.



Compliant with the Waste Electrical and Electronic Equipment/Restriction of the Use of Certain Hazardous Substances in Electrical and Electronic Equipment (WEEE) recycling directives.



## General description (Fig. 1)

- 1 Display
- 2 Measurement platform
- 3 Bluetooth® symbol
- 4 Measurement results
- 5 Battery low symbol
- 6 Bioelectrical impedance analysis (BIA)
- 7 Stone (st)
- 8 Pound (lb)
- 9 Kilogram (kg)
- 10 Feet of the scale
- 11 Measurement unit button
- 12 Battery compartment

## Intended use

The Philips body analysis scale measures body weight and uses bioelectrical impedance analysis (BIA) technology to estimate body fat percentage of healthy adults.

The device is intended for use in the home/domestic environment only.

# IMPORTANT SAFEGUARDS

### **Warning: READ ALL INSTRUCTIONS BEFORE USING**

When using battery-operated products, basic safety precautions should always be followed, including the following:

## Contraindications



- This device is contraindicated for women who are pregnant or think they are pregnant. The effects of this device on the fetus are unknown.
- This device is contraindicated for any person who is connected to a wearable or implanted electronic medical device or instrument such as a pacemaker or defibrillator. This device can cause the electronic medical device to malfunction.

## Warnings



- Keep the device out of reach of infants, children or pets, since inhalation or swallowing of small parts (e.g. carpet feet, batteries) can be dangerous or even fatal.
- Do not step on the device when your body or feet are wet, especially after bathing or showering to prevent slipping.
- Always check the device before you use it. Do not use the device if it is damaged, as this may cause injury.
- Only use this device for its intended use as described in this user manual.
- If the device will not be used on a regular basis, remove the batteries to prevent possible damage due to chemical leakage. If battery does leak, remove it carefully. Do not allow bare skin to touch leaking fluid.
- The device requires no calibration.
- The manufacturer does not require such preventive inspections by other persons.
- The device contains no user serviceable parts.

## Caution

- Any information provided by this device is in no way meant to treat, cure or prevent any disease or illness. If in doubt, contact your physician.
- This device should not be used by anyone who is acutely or chronically ill, suffering from a disease or taking medications that affect the amount of water in your body. The accuracy of readings for these patients has not been verified. Specific medical advice should be obtained from a physician.
- This device is equipped with a data transmission function. It may emit electromagnetic energy so as to perform its intended function. Nearby portable and mobile Radio Frequency (examples include cell phones, Bluetooth® equipped music players, speakers and headsets as well as Wifi access points) communication equipment can affect the performance of the device. The device can also interfere with electrical equipment in the vicinity. Therefore do not keep it in close proximity of portable and mobile Radio Frequency communication equipment.
- Use and store the device as described in the user manual.
- Do not expose the device to extreme temperatures, direct sunlight, moist or a corrosive environment (see 'Specifications').
- Do not expose the batteries to flames or fires, otherwise batteries may explode.
- No modifications of this device are allowed.
- Do not use the device on a slippery floor.
- Treat the scale with care. Do not drop it or jump on it.
- This device is not washable. Never immerse the device in water and do not rinse it under the tap.



# SAVE THESE INSTRUCTIONS

## Compliance with standards

- The device meets the relevant standards for this type of Class II electrical medical equipment for home use.
- This Philips device complies with all applicable standards and regulations regarding exposure to electromagnetic fields and complies with IEC 60601-1-2.
- This Philips device complies with applicable standards and regulations of the FCC Rules.

## Using the body analysis scale

This Philips body analysis scale automatically switches on as soon as you step on the measurement platform. The device applies BIA (bioelectrical impedance analysis) technology. Weak current flows through the human body to measure the bioelectrical impedance and estimate body fat percentage. The electrical current is small and may not be felt. This BIA technology is non-invasive. The electrical current mentioned above is less than 1mA.

## Preparing for use

### Inserting/removing the batteries

Insert new batteries (4x 1.5V AAA alkaline) before the first use.

Replace weak batteries before they discharge completely.

Note: Data will be lost when the battery is completely empty.

If you do not intend to use the device for a long period of time, it is advised to remove the batteries before storing.

**Caution: Replace all four batteries at the same time. Do not mix the old batteries with the new ones.**

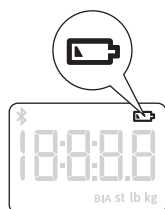

This device has a battery low indication. When the battery level is below operating value, this will be indicated by the low battery icon after which the device shall switch off within 4 sec.

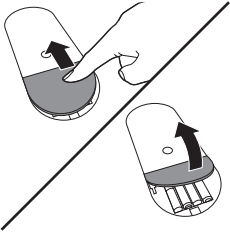

- 1 Open the battery compartment at the back of the device.
- 2 Insert the batteries (4x 1.5V AAA alkaline) into the battery compartment according to the polarity indications marked inside the compartment.

- The digits "8888" will show on the display.



- 3 Close the battery compartment and wait until the digits "0.0lb" are shown on the display. You can change measurement 'Setting the measurement unit' section.



## Placing the carpet feet

Soft surfaces such as carpet will affect the performance of the device. Always install the supplied carpet feet in case you place the device on a soft surface to prevent the soft surface from affecting the performance.

- 1 Remove the non-slip pads from the feet of the device.

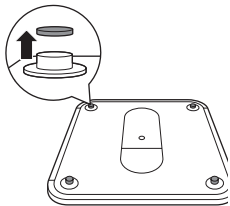

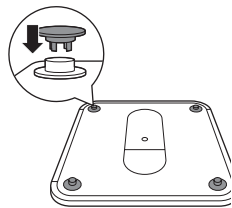

- 2 Fit the carpet feet firmly onto the feet of the device.

## Setting the measurement unit

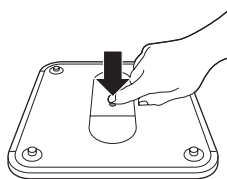

- 1 Press the measurement unit button in the bottom of the device to select the measurement unit.

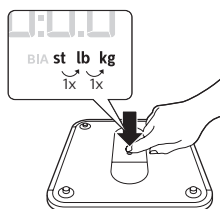

- 2 Press the measurement unit button again to switch between the available measurement units: kilograms, pounds and stones.

## Pairing the body analysis scale to your mobile device and create a user profile

Your Philips body analysis scale is equipped with Bluetooth® Smart. Download the Philips HealthSuite health app from the App store or Google Play. Use the search term 'Philips HealthSuite health app'. The app is available for iOS® 8.0+ and Android™ 4.4+.

Note: You can only use the Philips HealthSuite health app to communicate with the scale. It is not possible to use third party applications.

- 1 Download the Philips HealthSuite health app on your mobile device, start the Setup wizard and follow the steps to create a user profile and add the scale.
- 2 Make sure the app is open and Bluetooth® is on when pairing is in progress.
  - Keep the mobile device and the scale at transmission distance (no more than 16 feet / 5 meters from each other, in the same room).



- 3 To start the pairing process press the measurement unit button for 3 seconds.
  - These symbols are shown on the display alternately, indicating that the connection is being established.
  - If the connection has been established successfully, the display shows this symbol.
  - If the connection has failed, the display shows this symbol.
- 4 In the app, create the profile you want to use for the connection.
  - The scale can create 8 user profiles.
  - If all profiles are in use, choose an existing profile to overwrite.
- 5 Step on the scale barefoot to do an initial weighing. That weight is assigned to your user profile. The scale switches off automatically.

Note: If you want to edit your user profile later on, make sure the scale is turned on and connected to the health app.

## Measuring weight and body fat

### Tips for proper measurement

To ensure accurate measurements, please follow these instructions when you start measuring.

- Place the device on a flat, hard surface. Soft surfaces such as carpet affect the performance of the device. If you use the device on a soft surface, make sure you attach the carpet feet supplied to the feet of the device (see 'Placing the carpet feet'). This helps to prevent soft surfaces from affecting the performance of the device.
- A bioelectrical impedance analysis (BIA) measurement can only be performed if you are barefoot.
- Step onto the device barefoot, make sure your feet are slightly damp and clean. Stand still and keep full contact with the measurement platform until the measurement is complete. Be careful not to slip. The condition of the skin of the soles of your feet can affect the measurement. The natural effects of aging or activity can make this skin hard.
- Do not stand on the edge of the scale as you may fall or receive inaccurate measurements.
- Do not use the device on an uneven floor as it may result in unreliable data.
- Replace batteries before they are completely empty.
- For a meaningful comparison, try to measure under similar conditions. For example, take measurements at approximately the same time, on the same surface. Body fat percentage estimates will vary as a result of the amount of water in the body, and can be affected by dehydration or over-hydration due to such factors as alcohol consumption, menstruation, illness, intense exercise, etc.

We advise you not to use the scale in the following circumstances, as this may cause inaccurate measurements:

- Immediately after strenuous exercise.
- Immediately after a sauna or bath.
- Immediately after eating or drinking.

## Performing a measurement

### Performing a measurement with app

Note: Your personal measurement data can only be stored and displayed via the Philips body analysis scale and Philips HealthSuite health app and not by use of third party apps.

Note: When the scale is connected via Bluetooth® to the app of a user, the scale will automatically select that user and measurements can only be done for that user.

- 1 Switch on Bluetooth® on your mobile device and open the health app.
  - Keep the mobile device and the scale at transmission distance (no more than 16 feet / 5 meters from each other, in the same room).
  - The Bluetooth® symbol lights up when the scale is connected to the mobile device. The Bluetooth® symbol flashes when data transmission has succeeded.
- 2 Step onto the scale to switch it on. The scale beeps to indicate that it is ready for weighing. The scale is equipped with user profile recognition and automatically selects the user when the health app is connected.
  - You can take a measurement barefoot. The scale is able to perform the weight measurement and the BIA measurement and store this measurement data in the health app. Make sure your feet are clean and slightly damp.
  - You can also take a measurement wearing footwear. The scale is only able to perform the weight measurement and not the body fat estimation and BMI calculation. Your measurement results will not be stored or sent to the health app.
- 3 Weight measurement starts.
  - Weight is shown on the display of the scale after weight measurement ends.

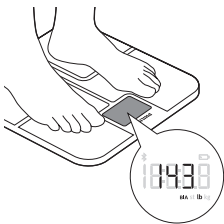



- 4 BIA measurement starts (when measuring barefoot).
  - The symbol 'BIA' flashes on the display to indicate the scale is analyzing your data.
- 5 Stand still and keep full contact with the measurement platform until the symbol 'BIA' stops flashing. The device beeps to indicate that the measurement is completed. The results of the BIA are shown in the app.

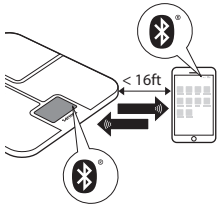

- 6 With the scale successfully connected to your mobile device, the measurement data is automatically transmitted to your mobile device via Bluetooth® Smart.
  - The Bluetooth® symbol on the scale flashes while the measurement data is transmitted to the app.
  - The measurement results are shown and stored in the health app.
- 7 After measuring, step off the scale. The scale switches off automatically.

## Performing a measurement without app

The scale can be used without the app. This allows you to measure your weight. When you have created a user profile in the scale, you can measure your weight and perform BIA. You can also upload your measurement data to the health app later on, when the scale and your mobile device are connected. Results of the body analysis measurement can only be accessed using the Philips HealthSuite health app. The scale cannot directly communicate BIA results to the user.



- 1 Step onto the scale barefoot to switch it on. The device beeps to indicate it is ready for weighing.
  - You can take a measurement barefoot. The device is able to perform the weight measurement and the BIA measurement and later on store the measurement data in the health app. Make sure your feet are clean and slightly damp.
  - You can also take a measurement wearing footwear. The scale is only able to perform the weight measurement and not the body fat estimation and BMI calculation. Your measurement results will not be stored or sent to the health app.
- 2 Weight measurement starts.
  - Weight is shown on the display of the device after weight measurement ends.

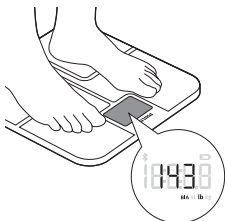





- 3 BIA measurement starts (when measuring barefoot).
  - The symbol 'BIA' flashes on the display to indicate the device is analyzing your data.
- 4 Stand still and keep full contact with the measurement platform until the symbol 'BIA' stops flashing. The device beeps to indicate that the measurement is completed. The results of the BIA will not be shown on the display.
- 5 The device is equipped with user profile recognition and automatically selects the user based on their weight.
  - When the device immediately displays the weight: no user is recognized and results are not stored. See below for instructions.
  - When the device shows multiple users: more users are recognized based on your weight. See below for instructions.
- 6 The measurement results are stored in the device in case of a successful BIA.
  - The device can store up to 40 measurement results for each user profile. The oldest results will be replaced by new measurement results.
- 7 After measuring, step off the device. It switches off automatically.

### When the device does not automatically recognize the correct user profile:

- To select the correct user profile, step off the device and tap on the measurement platform to confirm the correct user profile.
- All profiles will be shown alternately on the display. Tap on the scale to confirm your user profile.
- Make sure that you select the correct user.

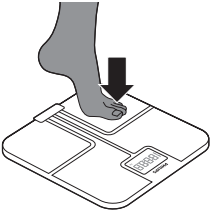

## Factory reset

To add up to 8 new user profiles or delete all measurement results from the device, you can perform a factory reset. With the factory reset the device is cleared from all existing user profiles and measurement results.

- 1 With the device turned on, press and hold the measurement unit button located on the bottom of the device for 20 seconds, until "FACT" is shown on the display. Now all data is deleted.
  - After resetting the scale will automatically turn off.
  - You can now create new users profiles (see 'Pairing the body analysis scale to your mobile device and create a user profile').

## Cleaning and storage

**Caution: Never immerse the device in water and do not rinse it under the tap.**

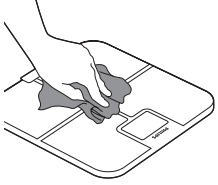

- 1 Wipe the surface of the device with a cloth.
  - Use a dry cloth to wipe dust off the surface of the device.
  - Use a slightly damp cloth to wipe dirt off the surface of the device. Dry the surface with a dry cloth after cleaning.

**Caution: Do not use propellant, abrasive or other chemicals to clean the device in order to avoid discoloration or malfunction of the scale.**

- 2 Store the device in a dry, dust-free place away from direct sunlight or other heat sources. Avoid surroundings with fluctuating temperatures (see Specifications').

**Caution: Do not drop the device.**

This device has no other user-serviceable parts. For assistance call 1-844-531-6861.

## Accessories

Philips accessories may be purchased at a store near you, or on our website [www.philips.com/store](http://www.philips.com/store).

## Disposal

This product contains batteries:

- Dispose of batteries properly. Do not incinerate. Batteries may explode if overheated.
- Do not wrap in metal or aluminum foil. Tape the waste battery terminals before discarding.
- It is suggested that you contact your local town or city to determine proper battery recycling site(s) in your area.
- Battery must be removed from the device before discarding.

## Assistance

For assistance, visit our website:

[www.philips.com/support](http://www.philips.com/support) or call toll free **1-844-531-6861**

## Full Two-Year Warranty

Philips Electronics North America Corporation warrants each new Philips product, models DL8781, DL8780, against defects in materials or workmanship for a period of two years from the date of purchase and agrees to repair or replace any defective product without charge.

**IMPORTANT:** This warranty does not cover damage resulting from accident, misuse or abuse, lack of reasonable care, the affixing of any attachment not provided with the product or loss of parts or subjecting the product to any but the specified voltage.\*

**NO RESPONSIBILITY IS ASSUMED FOR ANY SPECIAL, INCIDENTAL OR CONSEQUENTIAL DAMAGES.**

In order to obtain warranty service, simply go to [www.philips.com/support](http://www.philips.com/support) or call toll-free 1-844-531-6861. It is suggested that for your protection you return shipments of product by insured mail, insurance prepaid. Damage occurring during shipment is not covered by this warranty. **NOTE:** No other warranty, written or oral, is authorized by Philips Electronics North America Corporation. This warranty gives you specific legal rights, and you may also have other rights which vary from state to state. Some states do not allow the exclusion or limitation of incidental or consequential damages, so the above exclusion and limitations may not apply to you.

\* Read enclosed instructions carefully.

Manufactured for: Philips Consumer Lifestyle, A division of Philips Electronics North America Corporation, P.O. Box 10313, Stamford, CT 06904.

PHILIPS and Philips Shield are registered trademarks of Koninklijke Philips N.V.

## Troubleshooting

This chapter summarizes the most common problems you could encounter with the device. If you are unable to solve the problem with the information below, visit [www.philips.com/support](http://www.philips.com/support) for a list of frequently asked questions or call 1-844-531-6861 for assistance.

<b>Problem</b>	<b>Possible cause</b>	<b>Solution</b>
The display shows ---- and shuts down.	Maximum weight limit is reached. The scale has a weight limit of 28st 5 lb (397 lb) / 180 kg.	The scale can accommodate a maximum of 28 st 5 lb (397 lb) / 180 kg. Stop using this device.
The display shows the battery low symbol and switches off after a few seconds.	The batteries are almost empty.	Replace all four batteries at the same time. We advise you to replace batteries before they are completely empty. Use 4x 1.5V AAA alkaline batteries.
The display shows E1.	Pairing has failed.	Check if Bluetooth® on your mobile device is on, the Philips HealthSuite health app is open and if the scale and your mobile device are no more than 16 feet / 5 meters away from each other.

Problem	Possible cause	Solution
Unexpected measurement results .	Incorrect posture.	Please step on the measurement platform and stand still. When measuring barefoot, make sure your feet are clean and slightly damp.
	The device is placed on a soft surface such as a carpet or on an uneven surface.	Place the device on a flat, hard surface or attach the carpet feet supplied to the feet of the scale.
	Your feet are too dry.	Wipe your feet with a damp cloth to make sure that they are slightly damp when you take the measurement.
The display remains blank when the device is switched on.	There are no batteries in the device.	Insert 4x 1.5V AAA alkaline batteries (see 'Inserting/removing the batteries').
	The batteries are empty.	Replace all four batteries at the same time with new ones. Use 4x 1.5V AAA alkaline batteries.
The device does not perform measurement/analysis of body fat.	You are standing on the measurement platform wearing socks or shoes.	Make sure you are barefoot during the BIA measurement and keep full contact with the measurement platform. Make sure your feet are clean and slightly damp.
The device switches off automatically.	The batteries are empty.	Replace all four batteries at the same time. We advise you to replace batteries before they are completely empty. Use 4x 1.5V AAA alkaline batteries.
Data transmission failed.	Bluetooth® is off.	Turn on Bluetooth® on your mobile device.
	The Philips HealthSuite health app is off.	Press the icon on your mobile device to activate the health app.
	The scale and your mobile device are more than 16 feet / 5 meters away from each other.	Place your mobile device closer to the scale.
	When the profiles were shown alternately on the display, you selected the wrong profile.	Repeat the measurement and confirm the correct user profile by tapping on the scale.
When the profiles were shown alternately on the display, you selected the wrong profile.	You are standing on the measurement platform wearing socks or shoes.	Make sure you are barefoot during the BIA measurement and keep full contact with the measurement platform. Make sure your feet are clean and slightly damp.

# Specifications

---

Product name.	Philips body analysis scale with Bluetooth®.
Dimensions scale.	12 41/64 x 12 41/64 x 63/64 in / 321 x 321 x 25mm.
Net weight.	Approximately 4.4 lb / 1.98 kg (excluding the batteries).
Display.	LCD with white LED backlight.
Measurement units.	Kilogram / stone / pound.
Measurement range.	5kg to 180kg / Ost: 11lb to 28st: 5lb / 11lb to 397lb .
Graduations.	0.1kg / 0.1lb.
Accuracy.	5-50 kg: ±0.3 kg / 11-110 lb: ±0.7 lb. 50-100 kg: ±0.4 kg / 110-220 lb: ±0.9 lb. 100-150 kg: ±0.5 kg / 220-330 lb: ±1.1lb.
Measuring method	Bioelectrical Impedance Analysis (BIA) for body fat analysis.
Accuracy BIA	±15 ohms in the range of 200 – 1000 ohms.
Operating environment.	Temperature: 41°F to 104°F / 4,5°C to 40°C. Humidity: 15% RH to 93%RH, atmospheric pressure: 70kPa to 106kPa.
Storage and shipping environment.	Temperature: -4°F to 140°F / -20°C to 60°C. Humidity: 3 93% RH, atmospheric pressure: 50kPa to 106kPa.
Power source.	6V (4x 1.5V AAA alkaline batteries).
Switch-on method.	Sense-On technology.
Auto-off.	The device turns off after about 10 seconds in case of inactivity.
Accessories.	1. 4x 1.5V AAA alkaline batteries. 2. User manual. 3. Carpet feet.
Calibration of the device	The device requires no calibration.
The manufacturer does not require such preventive inspections by other persons.	The manufacturer does not require such preventive inspections by other persons.
Mode of operation	Continuous operation
Degree of protection against harmful ingress of water of particular matter	IP22
Applied part (measurement platform)	Type BF
Protection against electric shock	Internally powered

---

The device is not suitable for use in the presence of flammable anesthetic mixtures with air or with oxygen or nitrous oxide.

# Electromagnetic emissions and immunity

The device is approved according to EMC safety standard EN 60601-1-2. It is designed to be used in typical domestic environments.

## EMC Guidance

- The scale needs special precautions regarding EMC and needs to be installed and put into service according to the EMC information provided in the accompanying documents.
- Wireless communications equipment such as wireless home network devices, mobile phones, cordless telephones and their base stations, walkie-talkies can affect this equipment and should be kept at least a distance  $d = 3.3 \text{ m}$  (11ft) away from the equipment.

Note: As indicated in IEC 60601-1-2:2007 for ME equipment, a typical cell phone with a maximum output power of 2 W yields  $d = 3.3 \text{ m}$  (11ft) at an immunity level of 3V/m.

## Table 1 Guidance and manufacturer's declaration – electromagnetic emissions – for all ME equipment and ME systems

Guidance and manufacturer's declaration – electromagnetic emissions  
The device is intended for use in the electromagnetic environment specified below. The customer or the user of the device should assure that it is used in such an environment.

<b>Emissions test</b>	<b>Compliance</b>	<b>Electromagnetic environment - guidance</b>
RF emissions CISPR 11	Group 1	The device must emit electromagnetic energy in order to perform its intended function. Nearby electronic equipment may be affected.
RF emissions CISPR 11	Class B	
Harmonic emissions IEC 61000-3-2	Not applicable	
Voltage fluctuations/flicker emissions IEC 61000-3-3	Not applicable	

## Table 2 Guidance and manufacturer's declaration – electromagnetic immunity – for all ME equipment and ME systems

Guidance and manufacturer's declaration – electromagnetic immunity

The device is intended for use in the electromagnetic environment specified below. The customer or the user of the device should assure that it is used in such an environment.

Immunity test	IEC 60601 test level	Compliance level	Electromagnetic environment - guidance
Electrostatic discharge (ESD) IEC 61000-4-2	±6 kV contact ±8 kV air	±6 kV contact ±8 kV air	Floors should be wood, concrete or ceramic tile. If floors are covered with synthetic material, the relative humidity should be at least 30%.
Power frequency (50/60Hz) magnetic field IEC 61000-4-8	3A/m	3A/m	Power frequency magnetic fields should be at levels characteristic of a typical location in a typical commercial or hospital environment.

## Table 4 Guidance and manufacturer's declaration – electromagnetic immunity –for ME equipment and ME systems that are not life supporting

Guidance and manufacturer's declaration – electromagnetic immunity .

The device is intended for use in the electromagnetic environment specified below. The customer or the user of the device should assure that it is used in such an environment.

IMMUNITY test	IEC 60601 TEST LEVEL	Compliance level
Radiated RF IEC 61000-4-3	3 V/m 80 MHz to 2.5 GHz	3 V/m

### Electromagnetic environment - guidance

Portable and mobile RF communications equipment should be used no closer to any part of the device, including cables, than the recommended separation distance calculated from the equation applicable to the frequency of the transmitter.

Recommended separation distance:

$$d = 1.167 \sqrt{P}$$

$$d = 1.167 \sqrt{P} \quad 80 \text{ MHz to } 800\text{MHz}$$

$$d = 2.333 \sqrt{P} \quad 800 \text{ MHz to } 2.5 \text{ GHz}$$

where P is the maximum output power rating of the transmitter in watts (W) according to the transmitter manufacturer and d is the recommended separation distance in metres (m).

Field strengths from fixed RF transmitters, as determined by an electromagnetic site survey (a), should be less than the compliance level in each frequency range (b).



Interference may occur in the vicinity of equipment marked with the following symbol:

NOTE 1 At 80 MHz and 800 MHz, the higher frequency range applies.

NOTE 2 These guidelines may not apply in all situations. Electromagnetic propagation is affected by absorption and reflection from structures, objects and people.

(a) Field strengths from fixed transmitters, such as base stations for radio (cellular/cordless) telephones and land mobile radios, amateur radio, AM and FM radio broadcast and TV broadcast cannot be predicted theoretically with accuracy. To assess the electromagnetic environment due to fixed RF transmitters, an electromagnetic site survey should be considered. If the measured field strength in the location in which the device is used exceeds the applicable RF compliance level above, the device should be observed to verify normal operation. If abnormal performance is observed, additional measures may be necessary, such as re-orienting or relocating the device.

(b) Over the frequency range 150 kHz to 80 MHz, field strengths should be less than 3V/m.

## Table 6 Recommended separation distances between portable and mobile RF communications equipment and the ME equipment or ME system – for ME equipment and ME systems that are not life supporting

Recommended separation distances between portable and mobile RF communications equipment and the device.

The device is intended for use in an electromagnetic environment in which radiated RF disturbances are controlled. The customer or the user of the device can help prevent electromagnetic interference by maintaining a minimum distance between portable and mobile RF communications equipment (transmitters) and the device as recommended below, according to the maximum output power of the communications equipment.

### Separation distance according to frequency of transmitter (m)

Rated maximum output power of transmitter (W)	150 kHz to 80 MHz $d = 1.167 \sqrt{P}$	80 MHz to 800 MHz $d = 1.167 \sqrt{P}$	800 MHz to 2.5 GHz $d = 2.333$
0.01	0.117	0.117	0.233
0.1	0.369	0.369	0.738
1	1.167	1.167	2.333
10	3.690	3.690	7.378
100	11.67	11.67	23.33

For transmitters rated at a maximum output power not listed above, the recommended separation distance  $d$  in metres (m) can be estimated using the equation applicable to the frequency of the transmitter, where  $P$  is the maximum output power rating of the transmitter in watts (W) according to the transmitter manufacturer.



NOTE 1 At 80MHz and 800MHz, the separation distance for the higher frequency range applies.

NOTE 2 These guidelines may not apply in all situations. Electromagnetic propagation is affected by absorption and reflection from structures, objects and people.

## FCC Compliance information

This device complies with Part 15 of the FCC Rules. Operation is subject to the following two conditions: (1) this device may not cause harmful interference, and (2) this device must accept any interference received, including interference that may cause undesired operation.

FCC ID(2AEFK-DL8780 and 2AEFK-DL8781)

## Radio interference

This equipment has been tested and found to comply with the limits for a Class B digital device, pursuant to Part 15 of the FCC Rules. These limits are designed to provide reasonable protection against harmful interference in a residential installation. This equipment generates, uses and can radiate radio frequency energy and, if not installed and used in accordance with the instructions, may cause harmful interference to radio communications. However, there is no guarantee that interference will not occur in a particular installation.

If this equipment does cause harmful interference to radio or television reception, which can be determined by turning the equipment off and on, the user is encouraged to try to correct the interference by one or more of the following measures:

- Reorient or relocate the receiving antenna.
- Increase the separation between the equipment and receiver.
- Connect the equipment to an outlet on a circuit different from that to which the receiver is connected.
- Consult the dealer or an experienced radio/TV technician for help.

## RF Radiation exposure statement

This equipment complies with FCC RF radiation exposure limits set forth for an uncontrolled environment. For handheld/body-worn operation, this equipment has been tested and meets the FCC RF exposure guidelines. This transmitter must not be co-located or operating in conjunction with any other antenna or transmitter. Use of other accessories may not ensure compliance with FCC RF guidelines.

Do not attempt to repair or modify this equipment. Any repairs or alterations made by the user to the equipment may void the warranty and compliance of the equipment. Changes or modifications made to this equipment not expressly approved by Philips may void the FCC authorization to operate this equipment. For assistance visit our website [www.philips.com/support](http://www.philips.com/support) or call toll-free 1-844-531-6861.

## Bluetooth wordmark

The Bluetooth® Smart wordmark and logos are registered trademarks owned by Bluetooth SIG, Inc. and any use of such marks by Philips is under license.

## App Store and iPhone

App Store and iPhone are trademarks of Apple Inc., registered in the U.S. and other countries. App Store is a service mark of Apple Inc.

## Google Play and Android

Google Play and Android are trademarks of Google Inc.









Specifications are subject to change without notice.

© 2016 Koninklijke Philips N.V.

All rights reserved

Manufactured for:

Philips Consumer Lifestyle

A division of Philips Electronics North America Corporation

P.O. Box 10313, Stamford, CT 06904

4222.100.6188.1 (03/2016)



>75% recycled paper