

Register your product and get support at
www.philips.com/welcome

DCM3100



EN	User manual	3
CS	Příručka pro uživatele	27
DA	Brugervejledning	53
DE	Benutzerhandbuch	79

FR	Mode d'emploi	105
HU	Felhasználói kézikönyv	131
IT	Manuale utente	157
NL	Gebruiksaanwijzing	183

PHILIPS

Contents

1 Important	4
Safety	4
Notice	5
2 Your micro music system	7
Introduction	7
What's in the box	7
Overview of the main unit	8
Overview of the remote control	9
3 Before use	11
Place the product	11
Connect speakers	11
Connect the FM antenna	11
Connect power	12
Install/replace the remote control batteries	12
4 Get started	13
Turn on	13
Set the clock	13
Select a source	14
5 Play	14
Play a disc	14
Play from a USB storage device	14
Control play	15
Program tracks	15
6 Use the dock	16
Compatible iPod/iPhone models	16
Enjoy audio through the dock	17
Charge your iPod/iPhone	17
Unload your iPod/iPhone	17
7 Listen to FM radio	18
Tune to an FM radio station	18
Program radio stations automatically	18
Program radio stations manually	18
Tune to a preset radio station	18
Display RDS information	19
8 Adjust sound	19
Adjust volume level	19
Adjust bass level	19
Adjust treble level	19
Use automatic loudness control	19
Mute sound	19
9 Other features	20
Set alarm timer	20
Set sleep timer	20
Route audio from other devices	20
Listen through headphone	21
10 Product information	22
Specifications	22
USB playability information	23
Supported MP3 disc formats	23
RDS program types	23
Maintenance	24
11 Troubleshooting	25

1 Important

Safety

Read and understand all instructions before you use this micro music system. If damage is caused by failure to follow the instructions, the warranty does not apply.

Risk of electric shock or fire!

- Never expose the product and accessories to rain or water. Never place liquid containers, such as vases, near the product. If liquids are spilt on or into the product, disconnect it from the power outlet immediately. Contact Philips Consumer Care to have the product checked before use.
- Never place the product and accessories near naked flames or other heat sources, including direct sunlight.
- Never insert objects into the ventilation slots or other openings on the product.
- Where the mains plug or an appliance coupler is used as the disconnect device, the disconnect device shall remain readily operable.
- Disconnect the product from the power outlet before lightning storms.
- When you disconnect the power cord, always pull the plug, never the cable.

Risk of short circuit or fire!

- Before you connect the product to the power outlet, make sure that the power voltage matches the value printed on the back of the product. Never connect the product to the power outlet if the voltage is different.
- Never expose the remote control or batteries to rain, water, sunshine, or excessive heat.

- Avoid force coming onto power plugs. Loose power plugs can cause arcing or fire.

Risk of injury or damage to the product!

- Visible and invisible laser radiation when open. Avoid exposure to beam.
- Do not touch the disc optical lens inside the disc compartment.
- Never place the product or any objects on power cords or on other electrical equipment.
- If the product is transported in temperatures below 5°C, unpack the product and wait until its temperature matches room temperature before connecting it to the power outlet.

Risk of overheating!

- Never install this product in a confined space. Always leave a space of at least four inches around the product for ventilation.
- Make sure that curtains or other objects never cover the ventilation slots on the product.

Risk of contamination!

- Remove the battery if it is exhausted or if the remote control is not to be used for an extended period of time.
- Batteries contain chemical substances, they should be disposed of properly.

Risk of swallowing batteries!

- The product/remote control may contain a coin type battery, which can be swallowed. Keep the battery out of reach of children at all times!

Risk of decreased battery life!

- Never use batteries of different brands or types at the same time.
- Never use new and old batteries at the same time.

Notice

Any changes or modifications made to this device that are not expressly approved by Philips Consumer Lifestyle may void the user's authority to operate the equipment.

Compliance



This product complies with the radio interference requirements of the European Community.

This apparatus includes this label:



Care of the environment



Your product is designed and manufactured with high quality materials and components, which can be recycled and reused.



When this crossed-out wheeled bin symbol is attached to a product it means that the product is covered by the European Directive 2002/96/EC. Please inform yourself about the local separate collection system for electrical and electronic products.

Please act according to your local rules and do not dispose of your old products with your normal household waste. Correct disposal of

your old product helps to prevent potential negative consequences for the environment and human health.



Your product contains batteries covered by the European Directive 2006/66/EC, which cannot be disposed with normal household waste. Please inform yourself about the local rules on separate collection of batteries because correct disposal helps to prevent negative consequences for the environmental and human health.

Environmental information

All unnecessary packaging has been omitted. We have tried to make the packaging easy to separate into three materials: cardboard (box), polystyrene foam (buffer) and polyethylene (bags, protective foam sheet.)

Your system consists of materials which can be recycled and reused if disassembled by a specialized company. Please observe the local regulations regarding the disposal of packaging materials, exhausted batteries and old equipment.

Trademark notice



“Made for iPod” and “Made for iPhone” mean that an electronic accessory has been designed to connect specifically to iPod or iPhone respectively, and has been certified by the developer to meet Apple performance standards. Apple is not responsible for the operation of this device or its compliance with safety and regulatory standards. Please note that the use of this accessory with iPod or iPhone may affect wireless performance.

iPod and iPhone are trademarks of Apple Inc., registered in the U.S. and other countries.

Copyright



Be responsible
Respect copyrights

The making of unauthorized copies of copy-protected material, including computer programs, files, broadcasts and sound recordings, may be an infringement of copyrights and constitute a criminal offence. This equipment should not be used for such purposes.

2012 © Koninklijke Philips Electronics N.V. Specifications are subject to change without notice. Trademarks are the property of Koninklijke Philips Electronics N.V or their respective owners. Philips reserves the right to change products at any time without being obliged to adjust earlier supplies accordingly.



Note

- The type plate is located on the back of the system.

2 Your micro music system

Congratulations on your purchase, and welcome to Philips! To fully benefit from the support that Philips offers, register your product at www.philips.com/welcome.

Introduction

With this system, you can:

- enjoy audio from discs, USB storage devices, iPod/iPhone, and other external devices
- listen to FM radio stations

You can enrich sound output with these sound effects:

- Dynamic bass boost (DBB)
- Automatic loudness control

Playable media:

- Discs: CD-DA, CD-R, CD-RW, MP3-CD, WMA-CD
- Files: .mp3, .wma
- USB storage device
 - Compatibility: USB 1.1
 - Class support: MSC (Mass Storage Class)
 - File system: FAT12, FAT16, FAT32
 - Maximum number of albums/folders: 99
 - Maximum number of tracks/files: 999
 - Maximum level of directory: 8
- iPhone and iPod models
 - iPhone 4S
 - iPhone 4
 - iPhone 3GS
 - iPhone 3G
 - iPhone
 - iPod touch (1st, 2nd, 3rd, and 4th generation)
 - iPod nano (1st, 2nd, 3rd, 4th, 5th, and 6th generation)

- iPod classic
- iPod with video
- iPod with color display
- iPod mini

What's in the box

Check and identify the contents of the package:

- Micro music system
- AC power cord
- FM antenna
- MP3 link cable
- User manual
- Quick start guide

Overview of the main unit

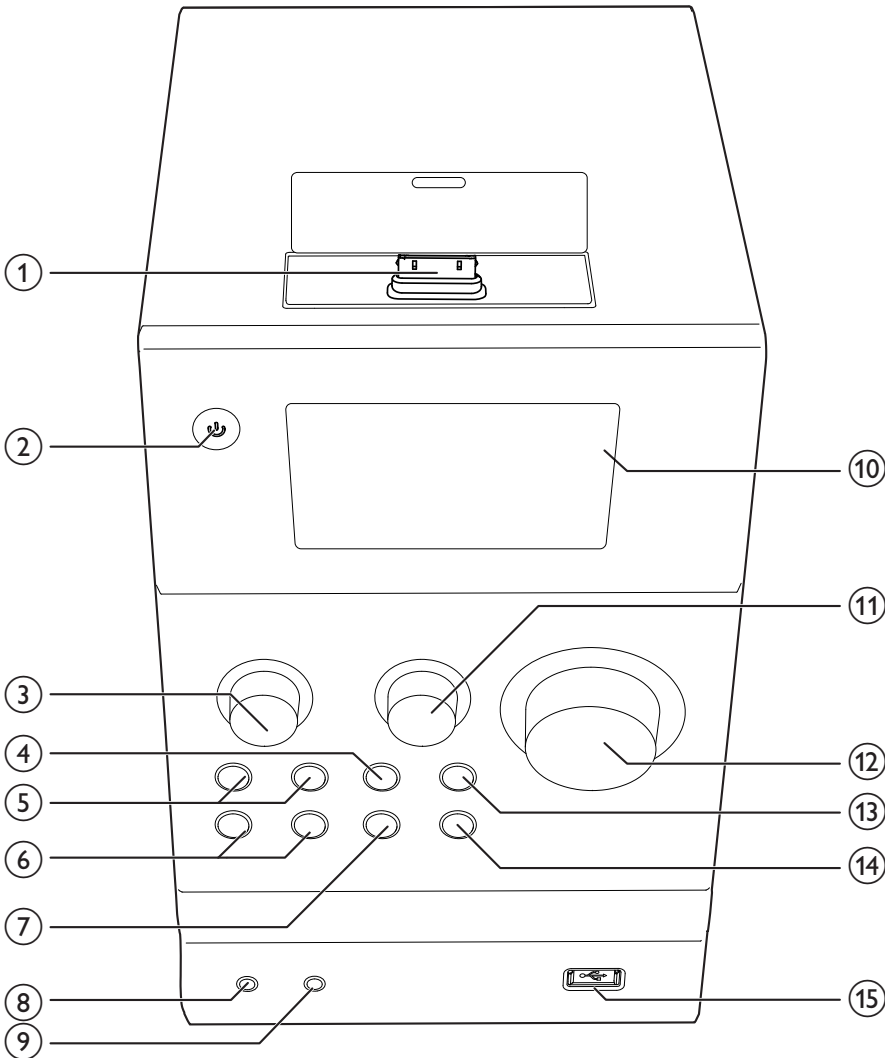

① Dock for iPhone/iPod

- Connect to an iPhone/iPod.

②

- Turn on the system.
- Switch the system to eco power standby mode or normal standby mode.

③ TREBLE

- Rotate to increase or decrease the treble level.

④

- Stop the play of a disc or .wma/mp3 file on a USB storage device.
- Press twice to erase a program.
- In disc mode, press and hold to eject the disc tray.

- In normal standby mode, enable or disable feature demonstration.
- Access the playlist of iPod/iPhone.

5 **⏮/⏭**

- Skip to the previous or next track.
- Press and hold to search within a track.
- Tune to a radio station.

6 **⏮/⏭**

- Skip to the previous or next album.
- Select a preset radio station.
- Navigate through the playlist of iPod/iPhone.

7 **SOURCE**

- Press repeatedly to select a source.

8 **🎧**

- Connect to a headphone with 3.5-mm connector.

9 **MP3-LINK**

- Connect to the audio output socket (usually the headphone socket) of an external device.

10 **VFD screen**

11 **BASS**

- Rotate to increase or decrease the bass level.

12 **VOLUME**

- Rotate to increase or decrease the volume level.

13 **▶||**

- Start, pause, or resume play.

14 **▲**

- Eject or close the disc compartment.

15 **🔌**

- Connect to a USB storage device.

Overview of the remote control

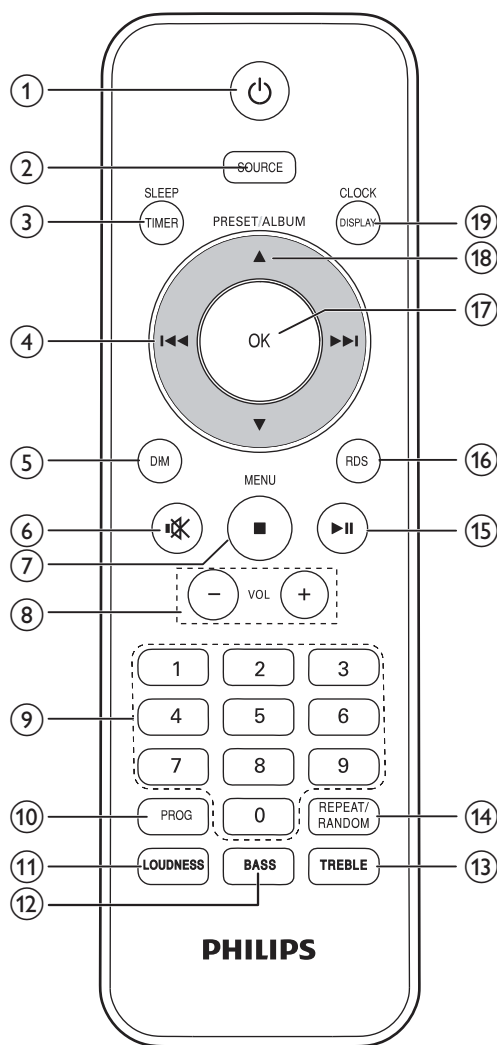

1 **⏻**

- Turn on the system.
- Switch the system to eco power standby mode or normal standby mode.

2 **SOURCE**

- Press repeatedly to select a source.

3 SLEEP/TIMER

- Set the sleep timer or alarm timer.

4 I◀◀ / ▶▶I

- Skip to the previous or next track.
- Press and hold to search within a track.
- Tune to a radio station.

5 DIM

- Adjust the brightness level of VFD screen.

6 静音

- Mute or restore volume.

7 ■ /MENU

- Stop the play of a disc or .wma/.mp3 file on a USB storage device.
- Press twice to erase a program.
- In disc mode, press and hold to eject the disc tray.
- In normal standby mode, enable or disable feature demonstration.
- Access the playlist of iPod/iPhone.

8 VOL +/-

- Rotate to increase or decrease the volume level.

9 Numeric keypad

- Enter the track number to select a track directly.
- Enter the sequence number to select a preset radio station.

10 PROG

- Program audio tracks.
- Program radio stations.

11 LOUDNESS

- Enable or disable the feature of automatic loudness control.

12 BASS

- Activate the adjustment of bass level.

13 TREBLE

- Activate the adjustment of treble level.

14 REPEAT/RANDOM

- Select a play mode: normal play, repeat, or shuffle play.

15 ▶||

- Start, pause, or resume play.

16 RDS

- Display available information of an RDS radio station.

17 OK

- Confirm an entry or selection.
- In FM mode, switch the sound setting between stereo and monophonic.

18 PRESET/ALBUM ▲ / ▼

- Skip to the previous or next album.
- Select a preset radio station.
- Navigate through iPod/iPhone playlist.

19 CLOCK/DISPLAY

- Set the clock.
- Display the current status or media information.
- Display available ID3 information of MP3 tracks.
- In working mode, press to display the clock.

3 Before use

Place the product

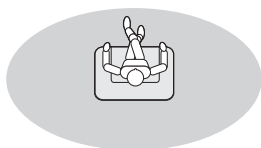

Place the speakers at an angle of approximately 45 degrees from the listening position.

Note

- To avoid magnetic interference or unwanted noise, never place this product too close to any radiation devices.

Connect speakers

Note

- For the best sound quality, use the supplied speakers only.
- Connect speakers with the same or higher impedance only. Refer to "Product information" > "Specifications" for details.

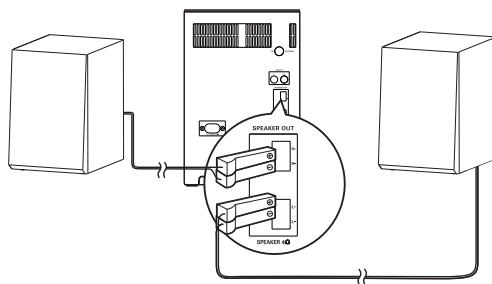

Connect the speaker cable plugs to the **SPEAKER OUT** sockets.

- the left one to the **L+/L-** socket
- the right one to the **R+/R-** socket

Connect the FM antenna

Note

- For optimal reception, fully extend the antenna and adjust its position, or connect an outdoor antenna.
- This product does not support MW (medium wave) radio reception.

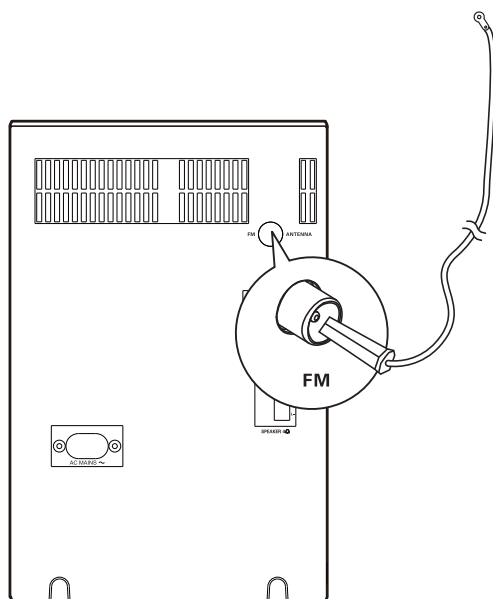

Connect the FM antenna to the **FM ANTENNA** socket on the back panel.

Connect power

Note

- Before you connect the AC power cord, make sure that you have completed all other connections.

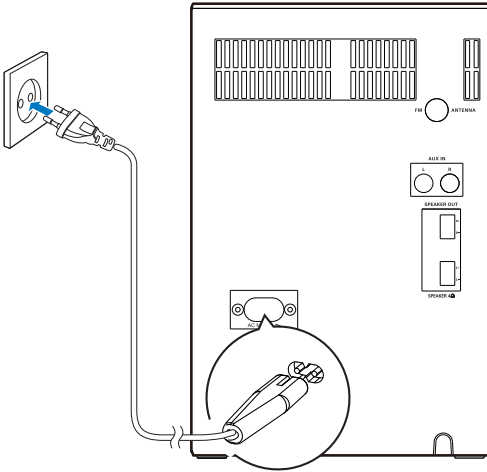

Connect the AC power cord to

- the **AC MAINS~** socket on the back panel, and
- the wall outlet.

Install/replace the remote control batteries

- 1 Open the battery compartment.

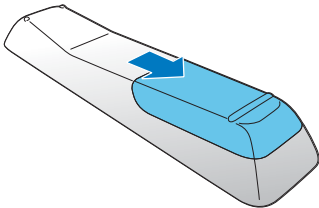

- 2 Insert 2 AAA batteries with correct polarity (+/-) as indicated.

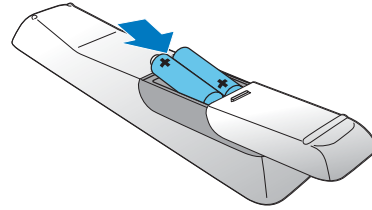

- 3 Close the battery compartment.

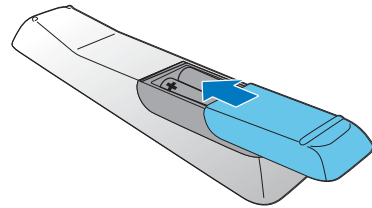

4 Get started

! Caution

- Use of controls or adjustments or performance of procedures other than herein may result in hazardous radiation exposure or other unsafe operation.

Always follow the instructions in this chapter in sequence.

Turn on

Press ϕ .

- ↳ This product switches to the last selected source.

Switch modes

Automatically switch the modes:

- After this product keeps inactive for 15 minutes, it automatically switches to the normal standby mode.
 - ↳ The clock is displayed.
 - ↳ If the clock is not set, ---- blinks.
- After this product keeps in the normal standby mode for 15 minutes, it automatically switches to the eco power standby mode.
 - ↳ *ECO STANDBY* scrolls, and then the VFD screen lights off.

Manually switch the modes:

- Press and hold ϕ to switch this product:
 - from the working mode or normal standby mode to the eco power standby mode.
 - from the eco power standby mode to the normal standby mode.
- Press ϕ to switch this product
 - between the working mode and a standby mode.

≡ Note

- When an iPod/iPhone is connected, this product does not switch to the eco-power standby mode.

Set the clock

≡ Note

- During setting, if no action is made within 90 seconds, the system exits clock setting without saving earlier operations.

- 1 In normal standby mode, press and hold **CLOCK/DISPLAY** to activate clock setting.
 - ↳ The hour digits blink.
- 2 Press **◀◀/▶▶** to set the hour, and then press **CLOCK/DISPLAY** to confirm.
 - ↳ The minute digits blink.
- 3 Press **◀◀/▶▶** to set the minute, and then press **CLOCK/DISPLAY** to confirm.
 - ↳ *24 HOUR* (24-hour time format) or *12 HOUR* (12-hour time format) is displayed with *24* or *12* blinking.
- 4 Press **◀◀/▶▶** to select the time format, and then press **CLOCK/DISPLAY** to confirm.
 - ↳ *RDS TIME SYNC [Y]* or *RDS TIME SYNC [N]* scrolls.
- 5 Press **◀◀/▶▶** to select *RDS TIME SYNC [Y]* to enable the system to automatically synchronize clock with an RDS station that transmits time signals.
 - To disable the automatic clock synchronization, select *RDS TIME SYNC [N]*.
- 6 Press **CLOCK/DISPLAY** to confirm the settings.
 - ↳ The set clock is displayed.
 - ↳ If you select *12 HOUR* as the time format, *AM* or *PM* is also displayed.

Select a source

Press **SOURCE** repeatedly to select a source.

- **BOOK**: the playlist on the connected iPhone/iPod
- **MP3-LINK**: the audio input through the **MP3-LINK** socket
- **AUX-IN**: the audio input through the **AUX-IN** sockets
- **DISC**: the disc in the disc compartment
- **USB**: .wma/.mp3 files stored on the connected USB storage device
- **TUNER**: the FM radio

5 Play

Play a disc

- 1 Press **SOURCE** repeatedly to switch the source to **DISC**.
- 2 Press **▲** to eject the disc tray.
- 3 Load a disc with the printed side facing up.
- 4 Press **▲** again to close disc compartment.
 - ↳ Play starts automatically after a few seconds.
 - If play does not start automatically, Press **▶||** to start play.

Play from a USB storage device

This system can play .mp3 and .wma files that are copied onto a supported USB storage device:

- Flash drive
- Memory card reader
- HDD: hard disc drive (This product can detect only a portable HDD with USB power peak current no more than 500 mA.)



Note

- Philips does not guarantee compatibility with all USB storage devices.
- NTFS (New Technology File System) file system is not supported.

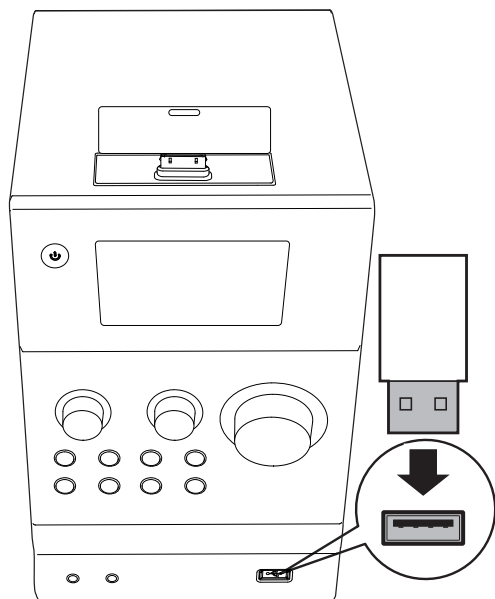

- 1 Connect the USB storage device to the socket.
- 2 Press **SOURCE** repeatedly to switch the source to **USB**.
↳ Play starts automatically.

If play does not start automatically,

- 1 Press **▲ / ▼** (or **◀ / ▶**) to select a folder.
- 2 Press **◀◀ / ▶▶** to select a file.
- 3 Press **▶||** to start the play.

Control play

During play, follow the instructions below to control play.

Buttons	Functions
▶ 	Pause or resume play.
■	Stop play.
◀◀ / ▶▶	Skip to the previous or next track. Press and hold to rewind a track or search forward fast within a track.

▲ / ▼, ◀ / ▶

Skip to the previous or next album when no less than one album exits.

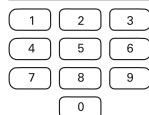

Enter the number of a track to play it.

REPEAT/RANDOM

Select an available play mode.

- **REPEAT 1**: repeat the current track
- **REPEAT**: repeat all tracks
- **GROUP REPEAT**: repeat the current album
- **RAND.**: play tracks randomly
- play tracks in sequence

RAND. is unavailable for programmed tracks.

Program tracks



Note

- You can program a maximum of 20 tracks.
- During programming, if no operation is made within 20 seconds, the system returns to stop mode without saving earlier operations.

For a CD

- 1 Press **■** to stop play.
↳ **TRK**, the total number of tracks, and the duration time are displayed.
- 2 Press **PROG** to activate the programming.
↳ **PROG.** and **PO 1** (the sequence number) are displayed with **00** blinking.

- 3 Press **◀◀/▶▶** to select a track.
↳ The track number blinks.
- 4 Press **PROG** again to program the selected track.
- 5 Repeat steps 3 and 4 to program more tracks.
- 6 Press **▶||** to start play.

For WMA/MP3 files

- 1 Press **■** to stop play.
↳ **■ XXX** (XXX indicates the total number of albums) and **■ XXX** (XXX indicates the total number of tracks) are displayed.
- 2 Press **PROG** to activate the programming.
↳ **PROG**, and **PD 1** are displayed with **■ ■ ■** blinking.
- 3 Press **ALBUM - /ALBUM +** repeatedly to select an album.
↳ **■ XX** (XX indicates the album number) blinks.
- 4 Press **PROG** again to confirm the selected album.
↳ **■ ■ ■** blinks.
- 5 Press **◀◀/▶▶** repeatedly to select a track.
↳ **■ XX** (XX indicates the track number) blinks.
- 6 Press **PROG** again to confirm the selected track.
- 7 Repeat steps 3 to 6 to program more tracks.
- 8 Press **▶||** to start play.

Erase the program

To erase the program,

- Press **■** twice.
- Switch to another source.

6 Use the dock

You can enjoy audio from iPod/iPhone through this system.



Note

- No audio output from the headphone socket in this situation.

Compatible iPod/iPhone models

This system supports the following iPod and iPhone models.

- iPhone 4S
- iPhone 4
- iPhone 3GS
- iPhone 3G
- iPhone
- iPod touch (1st, 2nd, 3rd, and 4th generation)
- iPod nano (1st, 2nd, 3rd, 4th, 5th, and 6th generation)
- iPod classic
- iPod with video
- iPod with color display
- iPod mini

Enjoy audio through the dock

Note

- The peak current through the dock connector is limited as 1,000 mA for iPod/iPhone. To avoid damage to your iPod/iPhone and this system, securely load your iPod/iPhone as indicated.

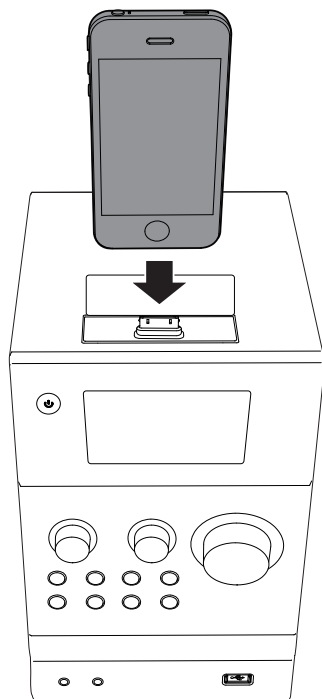

- 1 Press **SOURCE** repeatedly to switch the source to **iPOD/iPHONE**.
- 2 Flip up the dock lid.
- 3 Connect your iPod/iPhone to the dock.

- 4 Play a track on your iPod/iPhone.

Buttons	Functions
▶	Start, pause, or resume play.
MENU/■	Access the playlist of iPod/iPhone.
▲ / ▼	Navigate through the playlist of iPod/iPhone.
⏮ / ⏭	Skip to the previous/next track. Press and hold to rewind or search forward fast.

Charge your iPod/iPhone

Once the iPod/iPhone is docked and recognized, the charging starts.

Unload your iPod/iPhone

Note

- Risk of damage to the dock or your iPod/iPhone: Do not twist or shake your iPod/iPhone during unloading.

- 1 Pull the iPod/iPhone out of the dock.
- 2 Flip down to the lid to cover the dock.

7 Listen to FM radio

Tune to an FM radio station

Note

- Make sure that you have connected and fully extended the FM antenna.

- 1 Press **SOURCE** repeatedly to switch the source to *TUNER*.
- 2 Press and hold **◀◀ / ▶▶** until the frequency starts to change.
 - ↳ *SEARCH* blinks until the FM tuner tunes to a station with strong reception.
 - To tune to a station at a specific frequency, press **◀◀ / ▶▶** repeatedly until the desired frequency is displayed.

Tip

- In FM mode, you can press **OK** repeatedly to switch the sound setting between *STEREO* (stereo) and *MONO* (monophonic).

Program radio stations automatically

Note

- You can program a maximum of 20 preset radio stations.

- Press and hold **PROG** until *AUTO SCAN* blinks.
- ↳ All available stations are programmed in the order of waveband reception strength.
 - ↳ The first programmed radio station is broadcast automatically.

Program radio stations manually

Note

- You can program a maximum of 20 preset radio stations.
- To overwrite a programmed radio station, store another one with its sequence number.

- 1 Tune to a radio station.
- 2 Press **PROG** to activate programming.
 - ↳ *PRESET XX* (XX indicates the sequence number) blinks.
- 3 Press **▲ / ▼** or **◀ / ▶** to allocate a sequence number from 1 to 20 to this radio station, and then press **PROG** to confirm.
 - ↳ The preset sequence number and the frequency of this radio station are displayed.
- 4 Repeat steps 1-3 to program more stations.

Tune to a preset radio station

- Press **▲ / ▼** or **◀ / ▶** to select the sequence number of that preset radio station.
- Enter its sequence number with numeric keypad.

Display RDS information

RDS (Radio Data System) is a service that allows FM stations to show additional information. If you tune to an RDS radio station, RDS and the station name are displayed.

- 1 Tune to an RDS radio station.
- 2 Press **RDS** repeatedly to scroll through available information:
 - Station name
 - Program type such as **NEWS** (news), **SPORT** (sport), **POP M** (pop music)...
 - Text messages
 - RDS clock
 - Frequency

Synchronize clock with RDS

You can synchronize system clock with an RDS radio station.

- 1 Enable the system to automatically synchronize clock with an RDS station that transmits time signals (See “**Get started**” > “**Set the clock**”).
- 2 Tune to an RDS radio station that transmits time signals.
 - ↳ The system reads RDS time automatically.

Note

- The accuracy of the clock depends on the RDS radio station.

8 Adjust sound

The following operations are applicable to all supported media.

Adjust volume level

- On the remote control, press **VOL +/-** repeatedly.
- On the main unit, rotate **VOLUME** clockwise or anti-clockwise.

Adjust bass level

- On the remote control, press **BASS** to enable bass adjustment, and then press **VOL +/-** repeatedly.
- On the main unit, rotate **BASS** clockwise or anti-clockwise.

Adjust treble level

- On the remote control, press **TREBLE** to enable treble adjustment, and then press **VOL +/-** repeatedly.
- On the main unit, rotate **TREBLE** clockwise or anti-clockwise.

Use automatic loudness control

The loudness feature enables the system to increase the treble and bass sound effect at low volume automatically (the higher the volume, the lower the treble and bass increase).

- Press **LOUDNESS** to enable or disable automatic loudness control.

Mute sound

- Press **MUTE** to mute or restore the sound.

9 Other features

Set alarm timer

This product can be used as an alarm clock. You can select the disc, iPod/iPhone library, PHILIPS playlist, FM, or .wma/.mp3 files on a USB storage device as alarm source.

Note

- Make sure that you have set the clock correctly.
- If no playlist named "PHILIPS" exists in the iPod/iPhone or the playlist includes no playable track, this product switches the alarm source to iPod/iPhone library.
- If other alarm sources are unavailable, this product switches to FM mode automatically.

- 1 In normal standby mode, press and hold **SLEEP/TIMER** until **SET TIMER** (set the timer) and **SEL SOURCE** (select a source) scroll on the display.
↳ **DISC** is displayed.
- 2 Press **SOURCE** repeatedly to select an alarm source.
 - To use iPod/iPhone playlist as the alarm source, create a playlist named "PHILIPS" in your iPod/iPhone first.
- 3 Press **SLEEP/TIMER** to confirm.
↳ The hour digits blink.
- 4 Press **◀◀/▶▶** repeatedly to set the hour, and then press **SLEEP/TIMER** to confirm.
↳ The minute digits blink.
- 5 Press **◀◀/▶▶** to set the minute, and then press **SLEEP/TIMER** to confirm.
↳ **VOL XX** (XX indicates the volume level of alarm) blinks.
- 6 Press **VOL +/-** to set the alarm volume, and then press **SLEEP/TIMER** to confirm.
↳ **⏻** is displayed.

- To deactivate the alarm timer, press **SLEEP/TIMER** repeatedly in normal standby mode until **⏻** disappears.

Tip

- When the alarm sounds, you can press **VOL +/-** to adjust volume.

Set sleep timer

In working mode, press **SLEEP/TIMER** repeatedly to select a preset period (15, 30, 45, 60, 90, or 120 minutes).

- ↳ When sleep timer is activated, **SLEEP** is displayed on the lower-right corner of VFD screen.
- To deactivate sleep timer, press **SLEEP/TIMER** repeatedly until **SLEEP/POFF** is displayed.

Route audio from other devices

Through AUX-IN sockets

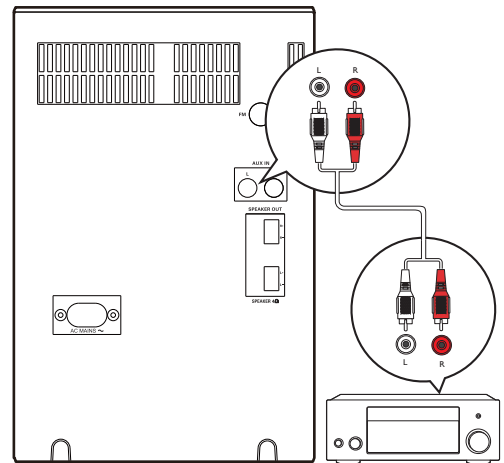

- 1 Connect an audio cable to
 - the **AUX IN L/R** sockets on the back panel of main unit, and
 - the analog 2-channel audio output sockets on the external device (for example, audio player).
- 2 Press **SOURCE** to switch the source to **AUX - IN**.
- 3 Play the external device.

Listen through headphone

Plug a headphone into the  socket on the front panel of main unit.

Note

- No audio output from the headphone socket when you listen to the docked iPod/iPhone. Listen through the speakers instead.

Through the MP3-LINK socket

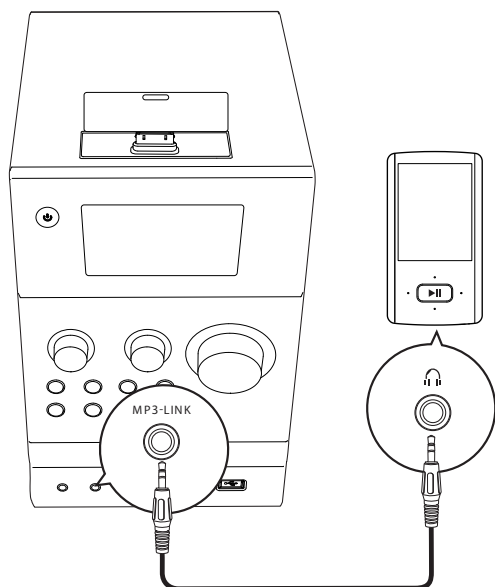

- 1 Connect an MP3 Link cable to
 - the **MP3-LINK** socket on the front panel of main unit, and
 - the headphone socket on the external device (for example, MP3 player).
- 2 Press **SOURCE** to switch the source to **MP3-LINK**.
- 3 Play the external device.

10 Product information

Note

- Product information is subject to change without prior notice.

Specifications

Amplifier

Maximum output power	2 X 30 W RMS
Frequency Response	40 Hz - 20 kHz
Signal to Noise Ratio	≥ 60 dB
Aux Input	1 V RMS 20 kOhm

Disc

Laser type	Semiconductor
Disc diameter	12 cm, 8 cm
Support discs	CD-DA, CD-R, CD-RW, MP3-CD, WMA-CD
Audio DAC	24 Bits, 44.1 kHz
Total harmonic distortion	< 3% (1 kHz)
Frequency response	40 Hz - 20 kHz (44.1 kHz)
S/N Ratio	> 55 dB

Tuner (FM)

Tuning range	87.5 - 108 MHz
Tuning grid	50 kHz
Sensitivity	
- Mono, 26dB S/N Ratio	< 22 dBf
- Stereo, 46dB S/N Ratio	> 43 dBf
Search selectivity	> 28 dBf
Total harmonic distortion	< 3%
Signal-to-noise ratio	> 55 dB

Speakers

Speaker Impedance	6 Ohm
Speaker Driver	4.5" woofer + 1" tweeter
Sensitivity	> 80 dB/m/W

General information

AC power	220 - 240 V ~, 50/60 Hz
Operation power consumption	35 W
Eco standby power consumption	≤ 0.5 W
Audio output	1 Vpp ± 0.1 Vpp 3.5 kOhm
Headphone output	2 x 3 mW 32 Ohm
USB Direct	Version 1.1
Dimensions	
- Main unit (W x H x D)	160 x 244 x 220 mm
- Speaker box (W x H x D)	160 x 244 x 210 mm
Weight	
- With packing	7.6 kg
- Main unit	1.8 kg
- Speaker box	2.2 kg x 2

USB playability information

Compatible USB devices:

- USB flash memory (USB1.1)
- USB flash players (USB1.1)
- Memory cards (an additional card reader is required)

Supported formats:

- USB or memory file format FAT12, FAT16, FAT32 (sector size: 512 bytes)
- MP3 bitrate (data rate): 32-320 kbps and variable bitrate
- WMA v9 or earlier
- Directory nesting up to a maximum of 8 levels
- Number of albums/folders: maximum 99
- Number of tracks/files: maximum 999
- ID3 tag v2.0 or later
- File name in Unicode UTF8 (maximum length: 16 bytes)

Unsupported formats:

- Empty albums: an album that does not contain MP3/WMA files
- Unsupported file formats are skipped. For example, Word documents (.doc) or MP3 files with extension .dlf are ignored and not played.
- AAC, WAV, PCM audio files
- DRM protected WMA files (.wav, .m4a, .m4p, .mp4, .aac)
- WMA files in Lossless format

Supported MP3 disc formats

- ISO9660, Joliet
- Maximum track/file number: 999 (depending on file name length)
- Maximum album number: 99
- Supported sampling frequencies: 32 kHz, 44.1 kHz, 48 kHz
- Supported bitrates: 32-320 kbps, variable bitrates

RDS program types

NO TYPE	No RDS programme type
NEWS	News services
AFFAIRS	Politics and current affairs
INFO	Special information programs
SPORT	Sports
EDUCATE	Education and advanced training
DRAMA	Radio plays and literature
CULTURE	Culture, religion and society
SCIENCE	Science
VARIED	Entertainment programs
POP M	Pop music
ROCK M	Rock music
MOR M	Light music
LIGHT M	Light classical music
CLASSICS	Classical music
OTHER M	Special music programs
WEATHER	Weather
FINANCE	Finance
CHILDREN	Children's programs
SOCIAL	Social Affairs
RELIGION	Religion
PHONE IN	Phone In
TRAVEL	Travel
LEISURE	Leisure
JAZZ	Jazz Music
COUNTRY	Country Music
NATION M	National Music
OLDIES	Oldies Music
FOLK M	Folk Music
DOCUMENT	Documentary
TES	Alarm Test
ALARM	Alarm

Maintenance

Clean the cabinet

- Use a soft cloth slightly moistened with a mild detergent solution. Do not use a solution containing alcohol, spirits, ammonia or abrasives.

Clean discs

- When a disc becomes dirty, clean it with a cleaning cloth. Wipe the disc from the centre out.

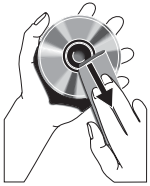

- Do not use solvents such as benzene, thinner, commercially available cleaners, or antistatic spray intended for analogue records.

Clean the disc lens

- After prolonged use, dirt or dust may accumulate at the disc lens. To ensure good play quality, clean the disc lens with Philips CD lens cleaner or any commercially available cleaner. Follow the instructions supplied with cleaner.

11 Troubleshooting



Warning

- Never remove the casing of this apparatus.

To keep the warranty valid, never try to repair the product yourself.

If you encounter problems when using this product, check the following points before requesting service. If the problem remains unsolved, go to the Philips Web page (www.philips.com/support). When you contact Philips, make sure that the product is nearby and the model number and serial number are available.

Problem	Solution
No power:	<p>Make sure that the AC power cord is connected properly.</p> <p>Make sure that there is power at the AC outlet.</p> <p>With a power-saving feature, the system switches off automatically 15 minutes after the system stays inactivity.</p>
No sound or poor sound.	<p>Adjust the volume.</p> <p>Disconnect the headphones.</p> <p>Make sure that the speakers are connected correctly.</p> <p>Make sure that the stripped speaker wires are clamped.</p>
No response from the system.	<p>Reconnect the AC power plug, and then turn on the system again.</p> <p>With a power-saving feature, the system switches off automatically 15 minutes after the system stays inactivity.</p>
Remote control does not work.	<p>Before you press any function button, select the correct source with the remote control instead of the main unit.</p> <p>Reduce the distance between the remote control and the main unit.</p> <p>Insert each battery with its polarity (+/- signs) aligned as indicated.</p> <p>Replace the batteries.</p> <p>Aim the remote control directly at the sensor on the front panel of the main unit.</p>
No disc is detected.	<p>Insert a disc.</p> <p>Make sure that you place the disc with its label facing upwards.</p> <p>Wait until the moisture condensation at the lens has cleared.</p> <p>Replace or clean the disc.</p> <p>Make sure that the recordable disc is finalized and the format supported.</p>
USB storage device is not supported.	<p>Make sure that the USB storage device is compatible with the system.</p> <p>Try another one.</p>

Problem	Solution
Cannot play some files on the USB storage device.	Make sure that the file format is supported. Make sure that the file quantity does not exceed the maximum.
Radio reception is poor.	Increase the distance between the system and other electrical appliances. Fully extend the antenna. Connect an outdoor FM/DAB antenna instead.
Timer does not work.	Set the clock correctly. Switch on the timer.
Clock/timer setting is erased.	Power has been interrupted or the AC power cord has been disconnected. Reset the clock/timer.

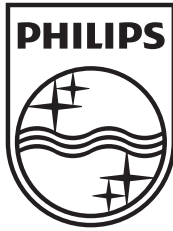

Specifications are subject to change without notice
© 2012 Koninklijke Philips Electronics N.V.
All rights reserved.

DCM3100_12_UM_V2.1

