

Register your product and get support at  
[www.philips.com/welcome](http://www.philips.com/welcome)

DCM3060



---

EN User manual	3
ZH-HK 使用手冊	21

---

**PHILIPS**

# Contents

<b>1</b>	<b>Important</b>	<b>4</b>	<b>7</b>	<b>Play iPod/iPhone/iPad</b>	<b>15</b>
	Safety	4		Compatible iPod/iPhone/iPad	15
	Notice	6		Load the iPod/iPhone/iPad	15
				Listen to the iPod/iPhone/iPad	16
				Charge the iPod/iPhone/iPad	16
<b>2</b>	<b>Your product</b>	<b>7</b>	<b>8</b>	<b>Other features</b>	<b>16</b>
	Introduction	7		Set the alarm timer	16
	What's in the box	7		Set the sleep timer	17
	Overview of the main unit	8		Play from an external device	17
	Overview of the remote control	9		Listen through the headphone	17
<b>3</b>	<b>Get started</b>	<b>10</b>	<b>9</b>	<b>Product information</b>	<b>17</b>
	Placement	10		Specifications	17
	Prepare the remote control	10		USB playability information	18
	Connect power	11		Supported MP3 disc formats	18
	Auto install radio stations	11		Maintenance	18
	Set clock	11	<b>10</b>	<b>Troubleshooting</b>	<b>19</b>
	Turn on	12			
<b>4</b>	<b>Play</b>	<b>12</b>			
	Play disc	12			
	Play from USB	12			
	Pause/resume play	12			
	Skip to a track	13			
	Search within a track	13			
	Display play information	13			
	Repeat and shuffle play	13			
	Program tracks	13			
<b>5</b>	<b>Adjust sound</b>	<b>14</b>			
	Adjust volume	14			
	Select a preset sound effect	14			
	Enhance bass	14			
	Mute sound	14			
<b>6</b>	<b>Listen to radio</b>	<b>14</b>			
	Tune to a radio station	14			
	Program radio stations automatically	14			
	Program radio stations manually	15			
	Select a preset radio station	15			

# 1 Important

## Safety



This 'bolt of lightning' indicates uninsulated material within your unit may cause an electrical shock. For the safety of everyone in your household, please do not remove product covering.

The 'exclamation point' calls attention to features for which you should read the enclosed literature closely to prevent operating and maintenance problems.

**WARNING:** To reduce the risk of fire or electric shock, this apparatus should not be exposed to rain or moisture and objects filled with liquids, such as vases, should not be placed on this apparatus.

**CAUTION:** To prevent electric shock, match wide blade of plug to wide slot, fully insert.

## Important Safety Instructions

- ① Read these instructions.
- ② Keep these instructions.
- ③ Heed all warnings.
- ④ Follow all instructions.
- ⑤ Do not use this apparatus near water.
- ⑥ Clean only with dry cloth.
- ⑦ Do not block any ventilation openings. Install in accordance with the manufacturer's instructions.
- ⑧ Do not install near any heat sources such as radiators, heat registers, stoves, or other apparatus (including amplifiers) that produce heat.
- ⑨ Protect the power cord from being walked on or pinched, particularly at plugs, convenience receptacles, and the point where they exit from the apparatus.
- ⑩ Only use attachments/accessories specified by the manufacturer.
- ⑪ Use only with the cart, stand, tripod, bracket, or table specified by the manufacturer or sold with the apparatus. When a cart is used, use caution when moving the cart/apparatus combination to avoid injury from tip-over. 
- ⑫ Unplug this apparatus during lightning storms or when unused for long periods of time.
- ⑬ Refer all servicing to qualified service personnel. Servicing is required when the apparatus has been damaged in any way, such as power-supply cord or plug is damaged, liquid has been spilled or objects have fallen into the apparatus, the apparatus has been exposed to rain or moisture, does not operate normally, or has been dropped.
- ⑭ **Battery usage CAUTION** – To prevent battery leakage which may result in bodily injury, property damage, or damage to the unit:
  - Install all batteries correctly, + and - as marked on the unit.
  - Do not mix batteries (old and new or carbon and alkaline, etc.).
  - Remove batteries when the unit is not used for a long time.

- Batteries (battery pack or batteries installed) shall not be exposed to excessive heat such as sunshine, fire or the like.
- ⑮ **Apparatus shall not be exposed to dripping or splashing.**
- ⑯ **Do not place any sources of danger on the apparatus (e.g. liquid filled objects, lighted candles).**
- ⑰ **Where the MAINS plug or an appliance coupler is used as the disconnect device, the disconnect device shall remain readily operable.**



### Warning

- Never remove the casing of this apparatus.
- Never lubricate any part of this apparatus.
- Never place this apparatus on other electrical equipment.
- Keep this apparatus away from direct sunlight, naked flames or heat.
- Never look into the laser beam inside this apparatus.
- Ensure that you always have easy access to the power cord, plug or adaptor to disconnect this apparatus from the power.



### Note

- The type plate is located at the rear of the apparatus.

## Hearing safety

### Listen at a moderate volume.

- Using headphones at a high volume can impair your hearing. This product can produce sounds in decibel ranges that may cause hearing loss for a normal person, even for exposure less than a minute. The higher decibel ranges are offered for those that may have already experienced some hearing loss.

- Sound can be deceiving. Over time your hearing 'comfort level' adapts to higher volumes of sound. So after prolonged listening, what sounds 'normal' can actually be loud and harmful to your hearing. To guard against this, set your volume to a safe level before your hearing adapts and leave it there.

### To establish a safe volume level:

- Set your volume control at a low setting.
- Slowly increase the sound until you can hear it comfortably and clearly, without distortion.

### Listen for reasonable periods of time:

- Prolonged exposure to sound, even at normally 'safe' levels, can also cause hearing loss.
- Be sure to use your equipment reasonably and take appropriate breaks.

### Be sure to observe the following guidelines when using your headphones.

- Listen at reasonable volumes for reasonable periods of time.
- Be careful not to adjust the volume as your hearing adapts.
- Do not turn up the volume so high that you can't hear what's around you.
- You should use caution or temporarily discontinue use in potentially hazardous situations. Do not use headphones while operating a motorized vehicle, cycling, skateboarding, etc.; it may create a traffic hazard and is illegal in many areas.

---

## Notice

Any changes or modifications made to this device that are not expressly approved by Philips Consumer Lifestyle may void the user's authority to operate the equipment.

---

## Care of the environment



Your product is designed and manufactured with high quality materials and components, which can be recycled and reused. Never dispose of your product with other household waste. Please inform yourself about the local rules on the separate collection of electrical and electronic products and batteries. The correct disposal of these products helps prevent potentially negative consequences on the environment and human health.

Your product contains batteries, which cannot be disposed of with normal household waste. Please inform yourself about the local rules on separate collection of batteries. The correct disposal of batteries helps prevent potentially negative consequences on the environment and human health.

Please visit [www.recycle.philips.com](http://www.recycle.philips.com) for additional information on a recycling center in your area.

### Environmental information

All unnecessary packaging has been omitted. We have tried to make the packaging easy to separate into three materials: cardboard (box), polystyrene foam (buffer) and polyethylene (bags, protective foam sheet.)

Your system consists of materials which can be recycled and reused if disassembled by a specialized company. Please observe the local regulations regarding the disposal of packaging materials, exhausted batteries and old equipment.



Be responsible  
Respect copyrights

The making of unauthorized copies of copy-protected material, including computer programs, files, broadcasts and sound recordings, may be an infringement of copyrights and constitute a criminal offence. This equipment should not be used for such purposes.

Made for



iPod



iPhone



iPad

"Made for iPod," "Made for iPhone," and "Made for iPad" mean that an electronic accessory has been designed to connect specifically to iPod, iPhone, or iPad, respectively, and has been certified by the developer to meet Apple performance standards. Apple is not responsible for the operation of this device or its compliance with safety and regulatory standards. Please note that the use of this accessory with iPod, iPhone, or iPad may affect wireless performance.

iPad, iPhone, iPod, iPod nano, and iPod touch are trademarks of Apple Inc., registered in the U.S. and other countries.



Windows Media and the Windows logo are trademarks, or registered trademarks of Microsoft Corporation in the United States and/or other countries.

This apparatus includes this label:



## 2 Your product

Congratulations on your purchase, and welcome to Philips! To fully benefit from the support that Philips offers, register your product at [www.philips.com/welcome](http://www.philips.com/welcome).

---

### Introduction

With this unit, you can enjoy audio from discs, iPod/iPhone/iPad, USB devices, and other external devices, or listen to radio stations. The unit offers Digital Sound Control (DSC) and Dynamic Bass Boost (DBB) to enrich sound.

The unit supports the following media formats:



---





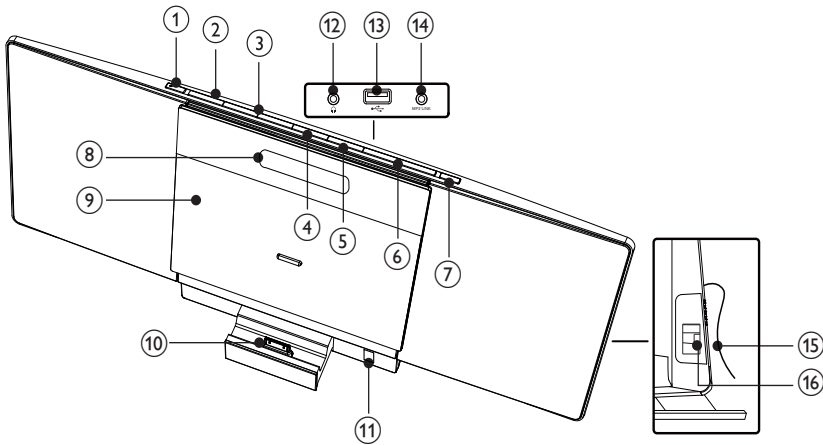

### What's in the box

Check and identify the contents of your package:

- Main unit
- Remote control
- 2 × AAA batteries
- AC power cable
- 1 × MP3 link cable
- Quick start guide
- User manual
- Wall mounting instructions
- Mounting kit (2 dowels and 2 screws)

## Overview of the main unit



- ① 
  - Turn on the unit, or switch to standby mode, or switch to Eco Power standby.
- ② **SOURCE**
  - Select a source: CD, FM radio, iPod/iPhone/iPad, USB, or MP3 link.
- ③ 
  - Skip to the previous/next track.
  - Search within a track.
  - Tune to a radio station.
- ④ 
  - Start or pause play.
  - Confirm a selection.
- ⑤ 
  - Stop play.
  - Access the iPod/iPhone menu.
- ⑥ **VOLUME + / -**
  - Adjust volume.
- ⑦ 
  - Open/close the disc compartment.
- ⑧ **Display panel**
  - Show current status.
- ⑨ **Disc compartment door**
- ⑩ **Dock for iPod/iPhone/iPad**
- ⑪ **Remote sensor**
  - Detect signal from the remote control.
- ⑫ 
  - Connector for the headphone.
- ⑬ 
  - Connector for a USB mass storage device.
- ⑭ **MP3 LINK**
  - Connector (3.5mm ) for an external audio device.
- ⑮ **FM antenna**
  - Improve FM reception.
- ⑯ **AC MAINS**
  - Connector for the AC power cable.

## Overview of the remote control

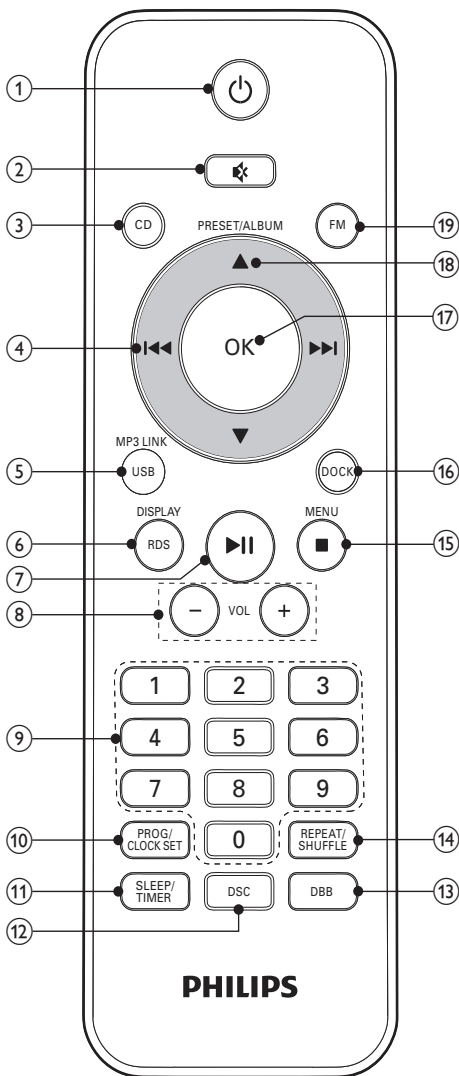

- ①
  - Turn on the unit, or switch to standby mode, or switch to Eco Power standby.
- ②
  - Mute or restore volume.
- ③ **CD**
  - Select disc source.
- ④
  - Skip to the previous/next track.
  - Search within a track.
  - Tune to a radio station.
- ⑤ **USB/MP3 LINK**
  - Select USB device source.
  - Select external audio device source.
- ⑥ **RDS/DISPLAY**
  - .RDS function is not available on this version of the unit.
  - Select display information during play.
- ⑦
  - Start or pause play.
- ⑧ **VOL +/-**
  - Adjust volume.
- ⑨ **Numeric keypad**
  - Select a track from a disc directly.
- ⑩ **PROG/CLOCK SET**
  - Program tracks.
  - Program radio stations.
  - Set the clock.
- ⑪ **SLEEP/TIMER**
  - Set the sleep timer.
  - Set the alarm timer.
- ⑫ **DSC**
  - Select a preset sound setting.
- ⑬ **DBB**
  - Turn on or off dynamic bass enhancement.
- ⑭ **REPEAT/SHUFFLE**
  - Play a track or all tracks repeatedly.
  - Play tracks randomly.



- ⑮ **■ /MENU**
  - Stop play.
  - Access the iPod/iPhone menu.
- ⑯ **DOCK**
  - Select iPod/iPhone/iPad source.
- ⑰ **OK**
  - Confirm a selection.
- ⑱ **PRESET/ALBUM ▲ / ▼**
  - Skip to the previous/next album.
  - Select a preset radio station.
  - Navigate the iPod/iPhone/iPad menu.
- ⑲ **FM**
  - Select FM radio source.

## 3 Get started

### Caution

- Use of controls or adjustments or performance of procedures other than herein may result in hazardous radiation exposure or other unsafe operation.

Always follow the instructions in this chapter in sequence.

If you contact Philips, you will be asked for the model and serial number of this apparatus. The model number and serial number are on the rear of the apparatus. Write the numbers here:  
Model No. \_\_\_\_\_  
Serial No. \_\_\_\_\_

---

### Placement

You can place the unit on a flat surface or mount the unit on a wall.

---

#### Mount on a wall

To wall mount the unit, see the included separate sheet of wall mounting instructions.

---

### Prepare the remote control

### Caution

- Risk of explosion! Keep batteries away from heat, sunshine, or fire. Never discard batteries in fire.

**To insert the remote control battery:**

- 1** Open the battery compartment.
- 2** Insert 2 AAA batteries with correct polarity (+/-) as indicated.
- 3** Close the battery compartment.

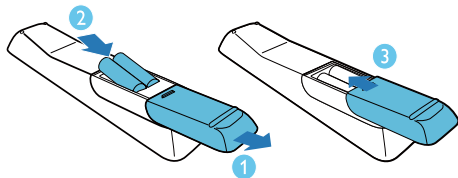

### Note

- If you are not going to use the remote control for a long time, remove the batteries.
- Do not use old and new or different types of batteries in combination.
- Batteries contain chemical substances, so they should be disposed of properly.

## Connect power

### Caution

- Risk of product damage! Make sure that the power supply voltage corresponds to the voltage printed on the rear of the main unit.
- Before connecting the AC cord, make sure that you have completed all other connections.

### Note

- The type plate is located on the rear of the main unit.

- 1 Connect the AC power cable to:
  - the **AC MAINS** connector on the rear of the unit.
  - the wall socket.

## Auto install radio stations

When you connect power and no radio stations are stored, the unit automatically begins to store radio stations.

- 1 Connect the unit to the power supply.
  - ↳ [AUTO INSTALL - PRESS PLAY KEY](auto install - press play key) is displayed.
- 2 Press **▶||** on the main unit to start installation.
  - ↳ The unit automatically stores radio stations with sufficient signal strength.
  - ↳ When all the available radio stations are stored, the first preset radio station is broadcast automatically.

## Set clock

### Note

- You can set the clock in standby mode only.

- 1 Press **⏻** to switch the unit to standby.
  - Make sure that --:-- (or clock) is displayed (see "Turn on" > "Switch to standby").
- 2 Press and hold **PROG/CLOCK SET** to activate the clock setting mode.
  - ↳ SET CLOCK is displayed.
  - ↳ The 12 hour or 24 hour format is displayed.
- 3 Press **◀◀/▶▶** to select 12 hour or 24 hour format.
- 4 Press **PROG/CLOCK SET**.
  - ↳ The hour digits begin to blink.
- 5 Press **◀◀/▶▶** to set the hour.
- 6 Press **PROG/CLOCK SET**.
  - ↳ The minute digits begin to blink.
- 7 Press **◀◀/▶▶** to set the minute.
- 8 Press **PROG/CLOCK SET** to confirm.



---

## Turn on

- 1 Press .
  - ↳ The unit switches to the last selected source.

---

## Switch to standby





- 1 When the unit is turned on, press  to switch the unit to standby.
  - In standby, press and hold  to switch from normal standby to Eco power standby or vice versa.
  - ↳ In normal standby, the clock (if set) appears on the display panel.
  - ↳ In Eco power standby, the backlight on the display panel turns off.

---

## 4 Play

---

### Play disc









- 1 Press **CD** to select the disc source.
- 2 Press  on the unit to open the disc compartment.
- 3 Insert a disc with the printed side facing outward, and then press  to close the disc compartment.
- 4 If the disc doesn't play, press .
  - To stop play, press .

---

### Play from USB

#### Note

- Make sure that the USB storage device contains playable audio content.

- 1 Connect the USB storage device into the  connector on the back panel of this unit.
- 2 Press **USB** to select the USB source.
  - ↳ Play starts automatically.
  - To select a folder, press  .
  - To select an audio file, press   / .
  - To start play, press .
  - To stop play, press .

---

### Pause/resume play

- 1 During play, press  to pause/resume play.

## Skip to a track

For CD:

- 1 Press **⏮/⏭** to select another track.
  - To select a track directly, you can also press a key on the numerical keypad.

For MP3 disc and USB:

- 1 Press **▲▼** to select an album or folder.
- 2 Press **⏮/⏭** to select previous/next track or file.

## Search within a track

- 1 During play, press and hold **⏮/⏭**
- 2 Release to resume normal play.

## Display play information

- 1 During play, press **DISPLAY** repeatedly to select different play information.

## Repeat and shuffle play

- 1 During play, press **REPEAT/SHUFFLE** repeatedly to select a play option.
  - **🔄**: the current track is played repeatedly.
  - **🔄ALL**: all the tracks are played repeatedly.
  - **🔀**: all tracks are played in a random order.
- 2 To return to normal play, press **REPEAT/SHUFFLE** repeatedly until no repeat/shuffle option is displayed.
  - You may also press **■** to cancel repeat/shuffle play.



Tip

- Shuffle play is not available when programmed tracks are played.

## Program tracks

You can program a maximum of 20 tracks.

- 1 In CD/USB mode, in the stop position, press **PROG/CLOCK SET** to activate the program mode.
  - ↳ [PROG] (program) and track number begin to blink.
- 2 For MP3 tracks, press **▲▼** to select an album.
- 3 Press **⏮/⏭** to select a track number, then press **PROG/CLOCK SET** to confirm.
- 4 Repeat steps 2 to 3 to program more tracks.
- 5 Press **▶||** to play the programmed tracks.
  - ↳ During play, [PROG] (program) is displayed.
    - To erase the program, in the stop position, press **■**.
      - ↳ [PROG] disappears on the display.

## 5 Adjust sound

---

### Adjust volume

- 1 During play, press **VOL +/-** to increase/decrease the volume.

### Select a preset sound effect

- 1 During play, press **DSC** repeatedly to select a preset sound setting.

### Enhance bass

- 1 During play, press **DBB** to turn dynamic bass enhancement on or off.
  - ↳ If DBB is activated, DBB is displayed.

### Mute sound

- 1 During play, press **MUTE** to mute/restore the speakers.

## 6 Listen to radio

---

### Tune to a radio station

- 1 Press **FM**.
- 2 Press and hold **◀◀ / ▶▶** for more than 2 seconds.
  - ↳ [SEARCH] (search) is displayed.
  - ↳ The radio tunes to a station with strong reception automatically.
- 3 Repeat step 2 to tune to more stations.
  - To tune to a weak station, press **◀◀ / ▶▶** repeatedly until you find optimal reception.



#### Tip

- Position the antenna as far as possible from TV, VCR, or other radiation source.
- For optimal reception, fully extend and adjust the position of the antenna.

### Program radio stations automatically

You can program a maximum of 20 preset radio stations (FM).

- 1 In FM mode, press and hold **PROG/ CLOCK SET** for more than 2 seconds to activate automatic program mode.
  - ↳ [AUTO] (auto) is displayed.
  - ↳ All available stations are programmed.
  - ↳ The first programmed radio station is broadcast automatically.

## Program radio stations manually



### Note

- You can program a maximum of 20 preset radio stations.

- 1 Tune to a radio station.
- 2 Press **PROG/CLOCK SET** to activate program mode.  
↳ [PROG] (program) begins to blink.
- 3 Press **▲▼** to allocate a number (1 to 20) to this radio station, and then press **PROG/CLOCK SET** to confirm.
- 4 Repeat the previous steps to program other stations.



### Note

- To overwrite a programmed station, store another station in its place.

## Select a preset radio station

- 1 In FM mode, press **▲▼** to select a preset number:

## 7 Play iPod/iPhone/iPad

You can enjoy audio from iPod/iPhone/iPad through this unit.

### Compatible iPod/iPhone/iPad

The unit supports the following iPod, iPhone and iPad models.

Made for:

iPod touch (1st, 2nd, 3rd, and 4th generation)

iPod nano (1st, 2nd, 3rd, 4th, 5th, and 6th generation)

iPhone 4

iPhone 3GS

iPhone 3G

iPhone

iPad 2

iPad

### Load the iPod/iPhone/iPad

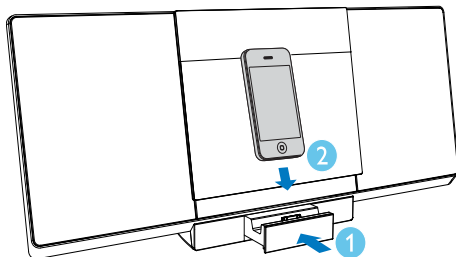

- 1 Push the dock compartment to open it.
- 2 Place the iPod/iPhone/iPad in the dock.

---

## Install the rubber pad

If necessary, install the supplied rubber pad to keep the iPad/iPad 2 stable before you place the iPad/iPad 2.

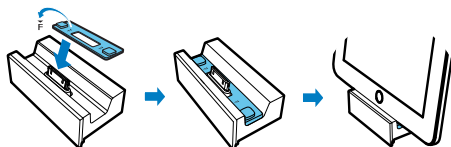

---

## Listen to the iPod/iPhone/iPad

- 1 Make sure that the iPod/iPhone/iPad is correctly placed.
- 2 Press **DOCK** to select the iPod/iPhone/iPad source.
- 3 Play music on the iPod/iPhone/iPad.
  - To pause/resume play, press **II**.
  - To skip to a track, press **◀▶**.
  - To search during play, press and hold **◀▶**, and then release to resume normal play.
  - To navigate the menu, press **MENU**, and press **▲▼** to select an option, and then press **OK** to confirm.

---

## Charge the iPod/iPhone/iPad

When the unit is connected to power, the docked iPod/iPhone/iPad begins to charge.

### Note

- The following iPod models cannot be charged: iPod classic, iPod with video, and iPod with color display.
- In Eco power standby mode, charge is not available.

---

# 8 Other features



---

## Set the alarm timer

This unit can be used as an alarm clock. The disc/radio/USB/docked product is activated to play at a preset time.

- 1 Make sure that you have set the clock correctly.
- 2 Press **⏻** to switch the unit to standby.
  - Make sure that the clock is displayed (see “Turn on” > “Switch to standby”).
- 3 Press and hold **SLEEP/TIMER**.
  - ↳ A prompt to select the source is displayed.
- 4 Press **CD**, **FM**, **USB** or **DOCK** to select a source.
- 5 Press **SLEEP/TIMER** to confirm.
  - ↳ The clock digits are displayed and begin to blink.
- 6 Press **◀▶** to set the hour.
- 7 Press **SLEEP/TIMER** to confirm.
- 8 Press **◀▶** to set the minute.
  - ↳ The timer is set and activated.

### To deactivate or re-activate an alarm timer

- 1 Press **⏻** to switch to standby mode.
- 2 Press **SLEEP/TIMER** repeatedly to activate or deactivate timer.
  - ↳ If timer is activated, the display shows .
  - ↳ If timer is deactivated,  disappears on the display.

### Note

- In MP3 link mode, the alarm timer cannot be set.
- If disc/USB/dock source is selected and the audio cannot be played, tuner is activated automatically.

## Set the sleep timer

This unit can switch to standby automatically after a set period of time.

- 1 When the unit is turned on, press **SLEEP/TIMER** repeatedly to select a set period of time (in minutes).
  - ↳ When sleep timer is activated, **zZ** is displayed.

### To deactivate sleep timer

- 1 Press **SLEEP/TIMER** repeatedly until [OFF] (off) is displayed.
  - ↳ When sleep timer is deactivated, **zZ** disappears on the display.

## Play from an external device

You can also listen to an external audio device through this unit.

- 1 Press **MP3 LINK** to select the MP3 link source.
- 2 Connect the supplied MP3 link cable to:
  - the **MP3 LINK** connector (3.5mm) on the unit.
  - the headphone connector on an external device.
- 3 Start to play the device (see the device's user manual).

## Listen through the headphone

Plug headphones (not supplied) into the  connector on the unit.

# 9 Product information



### Note

- Product information is subject to change without prior notice.

## Specifications

### Amplifier

Rated Output Power	2 x 20W RMS
Frequency Response	60 Hz - 16 kHz, $\pm 3$ dB
Signal to Noise Ratio	>65dBA
MP3 link input	500mv, 20kohm

### Tuner

Tuning Range	FM: 87.5 - 108 MHz
Tuning grid	50 KHz
FM sensitivity	
- Mono	26 dB
Total Harmonic Distortion	<2%
Signal to Noise Ratio	>55 dB
Number of presets	20 (FM)

### Speakers

Speaker Impedance	8 ohm
Speaker Driver	2 X 2.5" full range
Sensitivity	>82 dB/m/W



---

## General information

AC power	AC 100-240V~, 50/60 Hz
Operation Power Consumption	32 W
Eco Standby Power Consumption	<1 W
USB Direct	Version 2.0/1.1
Dimensions	
- Main Unit (W x H x D)	500 x 217 x 98 mm
Weight	
- Main Unit	2.614 kg

---

---

## USB playability information

### Compatible USB storage devices:

- USB flash memory (USB 2.0 or USB1.1)
- USB flash players (USB 2.0 or USB1.1)
- memory cards (requires an additional card reader to work with this system)

### Supported formats:

- USB or memory file format FAT12, FAT16, FAT32 (sector size: 512 bytes)
- MP3 bitrate (data rate): 32-320 Kbps and variable bitrate
- Directory nesting up to a maximum of 8 levels
- Number of albums/ folders: maximum 99
- Number of tracks/titles: maximum 999
- ID3 tag v2.0 or later
- File name in Unicode UTF8 (maximum length: 128 bytes)

### Unsupported formats:

- Empty albums: an empty album is an album that does not contain MP3 files, and is not shown in the display.
- Unsupported file formats are skipped. For example, Word documents (.doc) or MP3 files with extension .dlf are ignored and not played.
- AAC, WAV, PCM audio files

- DRM protected WMA files (\*.wav, \*.m4a, \*.m4p, \*.mp4, \*.aac)
- WMA files in Lossless format

---

## Supported MP3 disc formats

- ISO9660, Joliet
- Maximum title number: 999 (depending on file name length)
- Maximum album number: 99
- Supported sampling frequencies: 32 kHz, 44.1kHz, 48 kHz
- Supported Bit-rates: 32~256 (kbps), variable bit rates

---

## Maintenance

### Clean the cabinet

- Use a soft cloth slightly moistened with a mild detergent solution. Do not use a solution containing alcohol, spirits, ammonia or abrasives.

### Clean discs

- When a disc becomes dirty, clean it with a cleaning cloth. Wipe the disc from the centre out.
- Do not use solvents such as benzene, thinner, commercially available cleaners, or antistatic spray intended for analogue records.

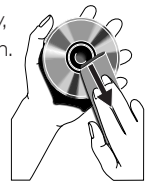

### Clean the disc lens

- After prolonged use, dirt or dust may accumulate at the disc lens. To ensure good play quality, clean the disc lens with Philips CD lens cleaner or any commercially available cleaner. Follow the instructions supplied with cleaner.

# 10 Troubleshooting



## Warning

- Never remove the casing of this apparatus.

To keep the warranty valid, never try to repair the system yourself.

If you encounter problems when using this apparatus, check the following points before requesting service. If the problem remains unsolved, go to the Philips web site ([www.philips.com/welcome](http://www.philips.com/welcome)). When you contact Philips, ensure that the apparatus is nearby and the model number and serial number are available.

### No power

- Ensure that the AC power plug of the unit is connected properly.
- Ensure that there is power at the AC outlet.
- To save power, the unit switches to standby automatically 15 minutes after a play reaches the end and no control is operated.

### No sound

- Adjust the volume.

### No response from the unit

- Disconnect and reconnect the AC power plug, then turn on the unit again.

### Remote control does not work

- Before pressing any function button, first select the correct source with the remote control instead of the main unit.
- Reduce the distance between the remote control and the unit.
- Insert the battery with its polarities (+/- signs) aligned as indicated.
- Replace the batteries.
- Aim the remote control directly at the sensor on the front of the unit.

### No disc detected

- Insert a disc.
- Check if the disc is inserted with the print side facing inward.
- Wait until the moisture condensation at the lens has cleared.
- Replace or clean the disc.
- Use a finalized CD or correct format disc.

### Cannot display some files in USB device

- The number of folders or files in the USB device has exceeded a certain limit. This phenomenon is not a malfunction.
- The formats of these files are not supported.

### USB device not supported

- The USB device is incompatible with the unit. Try another one.

### Poor radio reception

- Increase the distance between the unit and your TV or VCR.
- Fully extend and adjust the FM antenna.

### Timer does not work

- Set the clock correctly.
- Switch on the timer.

### Clock/timer setting erased

- Power has been interrupted or the power cord has been disconnected.
- Reset the clock/timer.

