

Register your product and get support at  
[www.philips.com/welcome](http://www.philips.com/welcome)

DCM1070



English	1	Ελληνικά	71
Čeština	17	Español	91
Dansk	35	Suomi	109
Deutsch	53	Français	127

**PHILIPS**

# Contents

---

<b>1 Important</b>	2
Safety	2
Notice	3

---

<b>2 Your Micro Music System</b>	5
Introduction	5
What's in the box	5
Overview of the main unit	5
Overview of the remote control	6

---

<b>3 Get started</b>	7
Prepare the remote control	7
Connect speakers	7
Connect power	7
Auto install radio stations	8
Set clock	8
Demonstrate features	8
Turn on	9

---

<b>4 Play</b>	9
Play disc	9
Play from USB	9
Adjust sound	9
Basic play operations	10

---

<b>5 Play iPod/iPhone</b>	11
Compatible iPod/iPhone	11
Load the iPod/iPhone	11
Charge the iPod/iPhone	11
Listen to the iPod/iPhone	11
Remove the iPod/iPhone	11

---

<b>6 Listen to radio</b>	12
Tune to a radio station	12
Program radio stations automatically	12
Program radio stations manually	12
Select a preset radio station	12

---

---

<b>7 Other features</b>	13
Set the timer	13
Set the sleep timer	13
Play from an external device	13
Headphone	14

---

<b>8 Product information</b>	14
Specifications	14
USB playability information	15
Maintenance	15

---

<b>9 Troubleshooting</b>	16
--------------------------	----

---

# 1 Important

---

## Safety



This 'bolt of lightning' indicates uninsulated material within your unit may cause an electrical shock. For the safety of everyone in your household, please do not remove product covering.

The 'exclamation point' calls attention to features for which you should read the enclosed literature closely to prevent operating and maintenance problems.

**WARNING:** To reduce the risk of fire or electric shock, this apparatus should not be exposed to rain or moisture and objects filled with liquids, such as vases, should not be placed on this apparatus.

**CAUTION:** To prevent electric shock, match wide blade of plug to wide slot, fully insert.

---

## Important Safety Instructions

- ① Read these instructions.
- ② Keep these instructions.
- ③ Heed all warnings.
- ④ Follow all instructions.
- ⑤ Do not use this apparatus near water.
- ⑥ Clean only with dry cloth.
- ⑦ Do not block any ventilation openings. Install in accordance with the manufacturer's instructions.
- ⑧ Do not install near any heat sources such as radiators, heat registers, stoves, or other apparatus (including amplifiers) that produce heat.
- ⑨ Protect the power cord from being walked on or pinched, particularly at plugs, convenience receptacles, and the point where they exit from the apparatus.
- ⑩ Only use attachments/accessories specified by the manufacturer.
- ⑪ Use only with the cart, stand, tripod, bracket, or table specified by the manufacturer or sold with the apparatus. When a cart is used, use caution when moving the cart/apparatus combination to avoid injury from tip-over.
- ⑫ Unplug this apparatus during lightning storms or when unused for long periods of time.
- ⑬ Refer all servicing to qualified service personnel. Servicing is required when the apparatus has been damaged in any way, such as power-supply cord or plug is damaged, liquid has been spilled or objects have fallen into the apparatus, the apparatus has been exposed to rain or moisture, does not operate normally, or has been dropped.
- ⑭ Battery usage **CAUTION** – To prevent battery leakage which may result in bodily injury, property damage, or damage to the unit:
  - Install all batteries correctly, + and - as marked on the unit.
  - Do not mix batteries (old and new or carbon and alkaline, etc.).



- Remove batteries when the unit is not used for a long time.
- Batteries (battery pack or batteries installed) shall not be exposed to excessive heat such as sunshine, fire or the like.

- ⑮ **Apparatus shall not be exposed to dripping or splashing.**
- ⑯ **Do not place any sources of danger on the apparatus (e.g. liquid filled objects, lighted candles).**
- ⑰ **Where the MAINS plug or an appliance coupler is used as the disconnect device, the disconnect device shall remain readily operable.**



### Warning

- Never remove the casing of this apparatus.
- Never lubricate any part of this apparatus.
- Never place this apparatus on other electrical equipment.
- Keep this apparatus away from direct sunlight, naked flames or heat.
- Never look into the laser beam inside this apparatus.
- Ensure that you always have easy access to the power cord, plug or adaptor to disconnect this apparatus from the power.

## Hearing safety

### Listen at a moderate volume.

- Using headphones at a high volume can impair your hearing. This product can produce sounds in decibel ranges that may cause hearing loss for a normal person, even for exposure less than a minute. The higher decibel ranges are offered for those that may have already experienced some hearing loss.
- Sound can be deceiving. Over time your hearing 'comfort level' adapts to higher volumes of sound. So after prolonged listening, what sounds 'normal' can actually be loud and harmful to your hearing. To guard against this, set your volume to a safe

level before your hearing adapts and leave it there.

### To establish a safe volume level:

- Set your volume control at a low setting.
- Slowly increase the sound until you can hear it comfortably and clearly, without distortion.

### Listen for reasonable periods of time:

- Prolonged exposure to sound, even at normally 'safe' levels, can also cause hearing loss.
- Be sure to use your equipment reasonably and take appropriate breaks.

### Be sure to observe the following guidelines when using your headphones.

- Listen at reasonable volumes for reasonable periods of time.
- Be careful not to adjust the volume as your hearing adapts.
- Do not turn up the volume so high that you can't hear what's around you.
- You should use caution or temporarily discontinue use in potentially hazardous situations. Do not use headphones while operating a motorized vehicle, cycling, skateboarding, etc.; it may create a traffic hazard and is illegal in many areas.

## Notice

Any changes or modifications made to this device that are not expressly approved by Philips Consumer Lifestyle may void the user's authority to operate the equipment.



This product complies with the radio interference requirements of the European Community.



Your product is designed and manufactured with high quality materials and components, which can be recycled and reused.



When this crossed-out wheeled bin symbol is attached to a product it means that the product is covered by the European Directive 2002/96/EC.

Please inform yourself about the local separate collection system for electrical and electronic products.

Please act according to your local rules and do not dispose of your old products with your normal household waste. Correct disposal of your old product helps to prevent potential negative consequences for the environment and human health.



Your product contains batteries covered by the European Directive 2006/66/EC, which cannot be disposed with normal household waste. Please inform yourself about the local rules on separate collection of batteries because correct disposal helps to prevent negative consequences for the environmental and human health.

### Environmental information

All unnecessary packaging has been omitted. We have tried to make the packaging easy to separate into three materials: cardboard (box), polystyrene foam (buffer) and polyethylene (bags, protective foam sheet.)

Your system consists of materials which can be recycled and reused if disassembled by a specialized company. Please observe the local regulations regarding the disposal of packaging materials, exhausted batteries and old equipment.



The making of unauthorized copies of copy-protected material, including computer programs, files, broadcasts and sound recordings, may be an infringement of copyrights and constitute a criminal offence. This equipment should not be used for such purposes.



"Made for iPod" and "Made for iPhone" mean that an electronic accessory has been designed to connect specifically to iPod or iPhone respectively, and has been certified by the developer to meet Apple performance standards. Apple is not responsible for the operation of this device or its compliance with safety and regulatory standards. Please note that the use of this accessory with iPod or iPhone may affect wireless performance.

iPod and iPhone are trademarks of Apple Inc., registered in the U.S. and other countries.

**This apparatus includes this label:**



### Note

- The type plate is located on the bottom of the apparatus.

## 2 Your Micro Music System

Congratulations on your purchase, and welcome to Philips! To fully benefit from the support that Philips offers, register your product at [www.philips.com/welcome](http://www.philips.com/welcome).

### Introduction

With this unit, you can:

- enjoy audio from discs, USB devices, iPod, iPhone, and other external devices
- listen to radio stations

You can enrich sound output with these sound effects:

- Digital Sound Control (DSC)
- Dynamic Bass Boost (DBB)

The unit supports these media formats:



### What's in the box

Check and identify the contents of your package:

- Main unit
- 2 x Speakers
- Power cord
- Remote control with 2 AAA batteries
- User manual
- Quick start guide

### Overview of the main unit

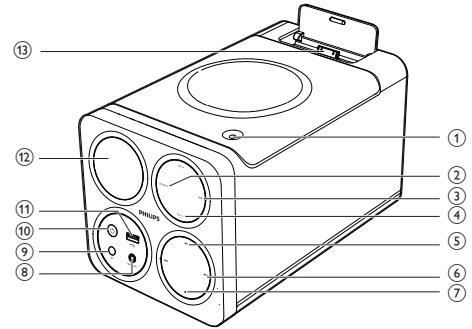

- ▲
  - Open or close the disc compartment.
- SOURCE**
  - Select a source: Disc, USB, tuner, Dock, or MP3 link.
- DBB**
  - Turn the dynamic bass enhancement on or off.
- VOL +/-**
  - Adjust volume.
  - Adjust time.
- ▶||
  - Start or pause play.
- ◀◀ / ▶▶
  - Skip to the previous/next track.
  - Search within a track.
  - Tune to a radio station.
- - Stop play or erase a program.
- MP3-LINK**
  - Connector (3.5mm) for an external audio device.
- iR sensor**
  - Detect signals from the remote control (always point the remote control towards the iR sensor).
- ⏻
  - Turn on the unit, or switch to standby mode, or switch to Eco Power standby mode.
- ←→
  - Connector for a USB device.
- Display panel**
  - Show current status.
- Dock for iPod/iPhone**

## Overview of the remote control

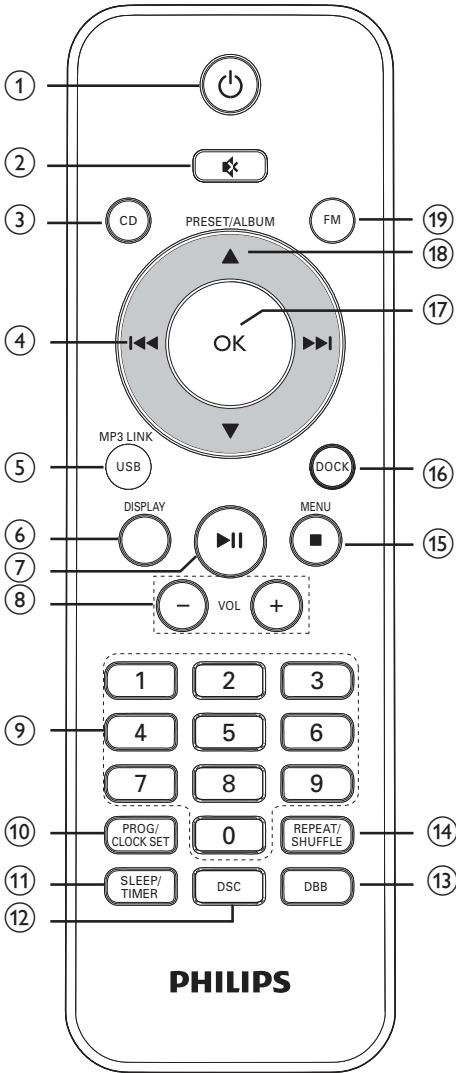

- ① **⏻**
  - Turn on the unit, or switch to standby mode, or switch to Eco Power standby.
- ② **🔇**
  - Mute or restore volume.
- ③ **CD**
  - Select disc source.

- ④ **⏮ / ⏭**
  - Skip to the previous/next track.
  - Search within a track.
  - Tune to a radio station.
- ⑤ **MP3 LINK / USB**
  - Select USB device source.
  - Select external audio device source.
- ⑥ **DISPLAY**
  - Select display information during play.
- ⑦ **⏸**
  - Start or pause play.
- ⑧ **VOL -/+**
  - Adjust volume.
  - Adjust time.
- ⑨ **Numeric keypad**
  - Select a track from a disc directly.
- ⑩ **PROG/CLOCK SET**
  - Set the clock.
  - Program tracks.
  - Program radio stations.
- ⑪ **SLEEP/TIMER**
  - Set the sleep timer.
  - Set the alarm timer.
- ⑫ **DSC**
  - Select a preset sound setting.
- ⑬ **DBB**
  - Turn the dynamic bass enhancement on or off.
- ⑭ **REPEAT/SHUFFLE**
  - Play a track or all tracks repeatedly.
  - Play tracks randomly.
- ⑮ **MENU / ■**
  - Stop play or erase a program.
  - Return to a previous iPod/iPhone menu.
- ⑯ **DOCK**
  - Dock for iPod/iPhone.
- ⑰ **OK**
  - Confirm a selection.
  - For FM radio, select stereo or mono sound output.
- ⑱ **PRESET/ALBUM ▲ / ▼**
  - Skip to the previous/next album.
  - Select a preset radio station.
  - Navigate through iPod/iPhone menu.
- ⑲ **FM**
  - Select FM radio source.

# 3 Get started



## Caution

- Use of controls or adjustments or performance of procedures other than herein may result in hazardous radiation exposure or other unsafe operation.

Always follow the instructions in this chapter in sequence.

If you contact Philips, you will be asked for the model and serial number of this apparatus. The model number and serial number are on the rear of the apparatus. Write the numbers here:

Model No. \_\_\_\_\_

Serial No. \_\_\_\_\_

## Prepare the remote control



## Caution

- Risk of explosion! Keep batteries away from heat, sunshine, or fire. Never discard batteries in fire.

To insert the remote control battery:

- 1 Open the battery compartment.
- 2 Insert 2 AAA batteries with correct polarity (+/-) as indicated.
- 3 Close the battery compartment.

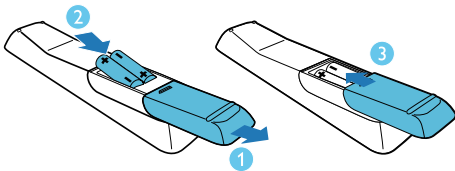

## Note

- If you are not going to use the remote control for a long time, remove the batteries.
- Do not use old and new or different types of batteries in combination.
- Batteries contain chemical substances, so they should be disposed of properly.

## Connect speakers



## Note

- For optimal sound, use the supplied speakers only.
- Connect only speakers with impedance that is the same or higher than the supplied speakers. Refer to the Specifications section of this manual.

Insert the speaker wires completely into the speaker input sockets on the back of the unit.

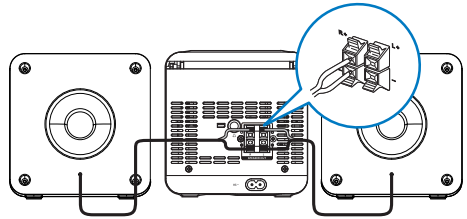

## Connect power



## Caution

- Risk of product damage! Make sure that the power supply voltage corresponds to the voltage printed on the rear of the main unit.
- Before connecting the AC cord, make sure that you have completed all other connections.



## Note

- The type plate is located on the rear of the main unit.



- 1 Connect the power cord to the **AC~** jack on the main unit.
- 2 Connect the power plug to the wall outlet.

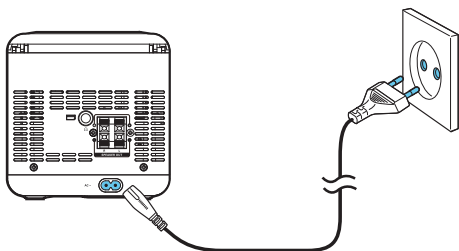

## Auto install radio stations

When you connect power and no radio stations are stored, the unit automatically begins to store radio stations.

- 1 Connect the unit to the power supply.
  - ↳ **[AUTO INSTALL - PRESS PLAY-STOP CANCEL]** (press **▶||** to start automatic installation, or press **■** to cancel) is displayed.
- 2 Press **▶||** on the main unit to start installation.
  - ↳ The unit automatically stores radio stations with sufficient signal strength.
  - ↳ When all the available radio stations are stored, the first preset radio station is broadcast automatically.

## Set clock

### Note

- You can set the clock in standby mode only.

- 1 Press **⏻** to switch the unit to standby.
- 2 Make sure that **--:--** (or clock) is displayed.

- 3 Press and hold **PROG/CLOCK SET** to activate the clock setting mode.
  - ↳ **[CLOCK SET]** (clock set) is displayed.
  - ↳ The 12 hour or 24 hour format is displayed.
- 4 Press **▲ / ▼** or **VOL -/+** to select 12 hour or 24 hour format.
- 5 Press **PROG/CLOCK SET**.
  - ↳ The hour digits begin to blink.
- 6 Press **▲ / ▼** or **VOL -/+** to set the hour.
- 7 Press **PROG/CLOCK SET**.
  - ↳ The minute digits begin to blink.
- 8 Press **▲ / ▼** or **VOL -/+** to set the minute.
- 9 Press **PROG/CLOCK SET** to confirm.

### Note

- To exit clock setting mode without storing, press **■**.
- If no button is pressed in 90 seconds, the system exits clock setting mode automatically.
- If clock is not manually set, when iPod/iPhone is connected, the unit synchronizes time from the iPod/iPhone automatically.

## Demonstrate features

- In the standby mode, press **■**
- ↳ **[WELCOME TO PHILIPS]** (welcome to Philips) scrolls on the display.
  - ↳ **[DEMO ON]** (demo on) scrolls on the display.
  - ↳ The feature names are displayed one by one.
  - To exit the feature demonstration, press **■** again.
  - ↳ **[DEMO OFF]** (demo off) scrolls on the display.

## Turn on

Press **⏻**.

- ↳ The unit switches to the last selected source.

## Switch to standby

When the unit is turned on, press **⏻** to switch the unit to standby.

- In standby, press and hold **⏻** over three seconds to switch from normal standby to Eco power standby or vice versa.
- ↳ In normal standby, the clock (if set) appears on the display panel.
- ↳ In Eco power standby, the backlight on the display panel turns off.

# 4 Play

## Play disc

- 1 Press **CD** to select the disc source.
- 2 Press **▲** on the unit to open the disc compartment.
- 3 Insert a disc with the printed side facing outward, and then press **▲** to close the disc compartment.
- 4 If the disc does not play, press **▶||**.
  - To stop play, press **■**.

## Play from USB



### Note

- Make sure that the USB storage device contains playable audio content.

- 1 Connect the USB storage device into the  connector on the front panel of this unit.
- 2 Press **USB** to select the USB source.
  - ↳ Play starts automatically.
  - To select a folder, press **▲** / **▼**.
  - To select an audio file, press **◀◀** / **▶▶**.
  - To start play, press **▶||**.
  - To stop play, press **■**.

## Adjust sound







During play, you can adjust volume through following operations.

Key	Function
<b>VOL +/-</b>	To increase/decrease the volume.

	To mute/restore sound.
DBB	To turn on or off dynamic bass enhancement. If DBB is activated, [DBB] is displayed.
DSC	To select your desired sound effect: [POP] (pop) [JAZZ] (jazz) [ROCK] (rock) [CLASSIC] (classic) [FLAT] (flat)

## Basic play operations





You can control play through following operations.

Key	Function
	To select a track or file. Press and hold to search a track during playback, then release to resume play.
	To pause/resume play during playback.
DISPLAY	To select different play information.
REPEAT/ SHUFFLE	To select a repeat play mode:  : play current track repeatedly.  ALL : play all tracks repeatedly.  ALB : the current album is played repeatedly.  : all tracks are played in a random order. Press  or Press REPEAT/ SHUFFLE repeatedly to return to normal play.

You can also use numeric keys to select a track directly.

## Program tracks

You can program a maximum of 20 tracks.

- In CD/USB mode, in the stop position, press **PROG/CLOCK SET** to activate the program mode.  
↳ [PROG] (program) and track number begin to blink.
- For MP3 tracks, press  /  to select an album.
- Press  to select a track number; then press **PROG/CLOCK SET** to confirm.
- Repeat steps 2 to 3 to program more tracks.
- Press  to play the programmed tracks.  
↳ During play, [PROG] (program) is displayed.
  - To erase the program, in the stop position, press .

## 5 Play iPod/iPhone

This system is equipped with a dock for iPod/iPhone. You can enjoy audio from the docked system through the powerful speakers.

### Compatible iPod/iPhone

The unit supports these iPod/iPhone models:

Made for:

- iPod touch (1st, 2nd, 3rd, and 4th generation)
- iPod classic
- iPod with video
- iPod nano (1st, 2nd, 3rd, 4th, 5th, and 6th generation)
- iPod with color display
- iPod mini
- iPhone 4
- iPhone 3GS
- iPhone 3G
- iPhone

### Load the iPod/iPhone

- 1 Push the lock key to open the lid of the dock.
- 2 Load the iPod/iPhone onto the dock.

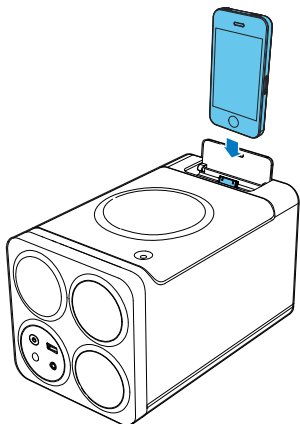

### Charge the iPod/iPhone

When the unit is connected to power, the docked iPod/iPhone starts charging automatically.

#### Note

- iPod with color display, iPod classic, and iPod with video are not compatible with dock charging.

#### Tip

- For certain iPod models, it may take up to a minute before the charging indication appears.

### Listen to the iPod/iPhone

- 1 Press **DOCK** to select the iPod/iPhone source.
- 2 Play the selected track on your docked iPod/iPhone.
  - To pause/resume the play, press **▶▶**.
  - To search during play: press and hold **◀◀ / ▶▶**, and then release to resume normal play.
  - To scroll through the menu, press **▲ / ▼**.
  - To confirm a selection, press **OK** to confirm.

### Remove the iPod/iPhone

- 1 Unload the iPod/iPhone from the dock.
- 2 Flip down the lid to hide the dock.

# 6 Listen to radio

---

## Tune to a radio station

- 1 Press **FM**.
- 2 Press and hold **◀◀ / ▶▶** over two seconds.
  - ↳ **[SEARCH]** (search) is displayed.
  - ↳ The radio tunes to a station with strong reception automatically.
- 3 Repeat step 2 to tune to more stations.
  - To tune to a weak station, press **◀◀ / ▶▶** repeatedly until you find optimal reception.
  - To achieve sound quality, press **OK** on remote control repeatedly to select stereo or mono sound.



### Tip

- Position the antenna as far as possible from TV, VCR, or other radiation source.
- For optimal reception, fully extend and adjust the position of the antenna.

---

## Program radio stations automatically

You can program a maximum of 20 preset radio stations (FM).

In **FM** mode, press and hold **PROG/CLOCK SET** over two seconds to activate automatic program mode.

- ↳ **[AUTO]** (auto) is displayed.
- ↳ All available stations are programmed.
- ↳ The first programmed radio station is broadcast automatically.

---

## Program radio stations manually



### Note

- You can program a maximum of 20 preset radio stations.

- 1 Tune to a radio station.
- 2 Press **PROG/CLOCK SET** to activate program mode.
  - ↳ **[PROG]** (program) begins to blink.
- 3 Press **▲ / ▼** to allocate a number (1 to 20) to this radio station, and then press **PROG/CLOCK SET** to confirm.
- 4 Repeat the previous steps to program other stations.



### Note

- To overwrite a programmed station, store another station in its place.

---

## Select a preset radio station

In **FM** mode, press **▲ / ▼** to select a preset number:

# 7 Other features

## Set the timer

This unit can be used as a timer. The disc/tuner/USB/dock is activated to play at a preset time.



### Note

- Make sure that you have set the clock correctly.

- 1 In standby mode, press and hold **SLEEP/TIMER** until **[TIMER SET]** (timer set) scrolls on the display.  
↳ **[SELECT SOURCE]** (select source) scrolls on the display.
- 2 Press **CD**, or **FM**, or **USB**, or **DOCK** to select a source.
- 3 Press **SLEEP/TIMER** to confirm.  
↳ The clock digits are displayed and begin to blink.
- 4 Press **▲ / ▼** or **VOL -/+** to set hour, then press **SLEEP/TIMER** to confirm.  
↳ The minute digits are displayed and begin to blink.
- 5 Press **▲ / ▼** or **VOL -/+** to set minute, then press **SLEEP/TIMER** to confirm.  
↳ **[VOL]** (volume) is displayed and begins to blink.
- 6 Press **▲ / ▼** or **VOL -/+** to adjust volume, then press **SLEEP/TIMER** to confirm.  
↳ The timer is set and activated, and  is displayed.

## Activate/deactivate alarm timer

In standby mode, press **SLEEP/TIMER** repeatedly to activate or deactivate timer.  
↳ If timer is activated,  is displayed.



### Note

- Alarm timer is not available in MP3 LINK mode.
- If DISC/USB/iPod/iPhone source is selected, yet no disc is placed or no USB/iPod/iPhone connected, the system switches to the tuner source automatically.
- If iPod/iPhone playlist is selected as the alarm source, you need create a playlist called "PHILIPS" in your iPod/iPhone.
- If no playlist called "PHILIPS" is created in the iPod/iPhone or no track is stored in the playlist, the unit switches to TUNER alarm source.

## Set the sleep timer

This unit can switch to standby automatically after a set period of time.

When the unit is turned on, press **SLEEP/TIMER** repeatedly to select a set period of time (in minutes):

- **[120 SLEEP]**
  - **[90 SLEEP]**
  - **[60 SLEEP]**
  - **[45 SLEEP]**
  - **[30 SLEEP]**
  - **[15 SLEEP]**
- ↳ When sleep timer is activated, **zZ** is displayed.

### To deactivate sleep timer

Press **SLEEP/TIMER** repeatedly until **[OFF SLEEP]** (off sleep) is displayed.

- ↳ When sleep timer is deactivated, **zZ** disappears.

## Play from an external device

You can also listen to an external audio device through this unit.

- 1 Press **MP3 LINK** to select the MP3 link source.
- 2 Connect MP3 link cable to:
  - the **MP3 LINK** connector (3.5mm) on the unit.

- the headphone connector on an external device.

- 3 Start to play the device (see user manual of the device).

## Headphone

Plug headphones (not supplied) into the  connector on the unit to listen through the headphones.

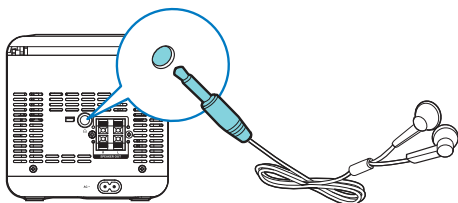

# 8 Product information



### Note

- Product information is subject to change without prior notice.

## Specifications

### General information

AC power	AC 110-240V~, 50/60 Hz
Operation Power Consumption	22 W
Eco Standby Power Consumption	<0.5 W
USB Direct	Version 2.0/1.1
Dimensions	
- Main Unit (W x H x D)	140 x 143 x 250 mm
- Speaker box (W x H x D)	140 x 143 x 198 mm
Weight	
- Main Unit	1.01 kg
- Speaker box	0.72 kg x 2

### Amplifier

Max Output Power	2 x 5 W (-1dB)
Frequency Response	40 Hz - 20 kHz, $\pm 3$ dB
Signal to Noise Ratio	>72 dBA
MP3 link input	500-1000 mV RMS 20kohm

## Tuner

Tuning Range	FM: 87.5 - 108 MHz
Tuning grid	50 KHz
FM sensitivity - Mono	26 dB
Total Harmonic Distortion	<2%
Signal to Noise Ratio	>55 dB
Number of presets	20 (FM)

## Speakers

Speaker Impedance	4 ohm
Speaker Driver	2 X 3" full range
Sensitivity	>82 dB/m/W

## USB playability information

### Compatible USB storage devices:

- USB flash memory (USB 2.0 or USB1.1)
- USB flash players (USB 2.0 or USB1.1)
- memory cards (requires an additional card reader to work with this system)

### Supported formats:

- USB or memory file format FAT12, FAT16, FAT32 (sector size: 512 bytes)
- MP3 bitrate (data rate): 32-320 Kbps and variable bitrate
- Directory nesting up to a maximum of 8 levels
- Number of albums/ folders: maximum 99
- Number of tracks/titles: maximum 999
- ID3 tag v2.0 or later
- File name in Unicode UTF8 (maximum length: 128 bytes)

### Unsupported formats:

- Empty albums: an empty album is an album that does not contain MP3 files, and is not shown in the display.

- Unsupported file formats are skipped. For example, Word documents (.doc) or MP3 files with extension .dlf are ignored and not played.
- AAC, WAV, PCM audio files
- DRM protected WMA files (\*.wav, \*.m4a, \*.m4p, \*.mp4, \*.aac)
- WMA files in Lossless format

## Maintenance

### Clean the cabinet

- Use a soft cloth slightly moistened with a mild detergent solution. Do not use a solution containing alcohol, spirits, ammonia or abrasives.

### Clean discs

- When a disc becomes dirty, clean it with a cleaning cloth. Wipe the disc from the centre out.



- Do not use solvents such as benzene, thinner; commercially available cleaners, or antistatic spray intended for analogue records.

### Clean the disc lens

- After prolonged use, dirt or dust may accumulate at the disc lens. To ensure good play quality, clean the disc lens with Philips CD lens cleaner or any commercially available cleaner. Follow the instructions supplied with cleaner.



# 9 Troubleshooting



## Warning

- Never remove the casing of this apparatus.

To keep the warranty valid, never try to repair the system yourself.

If you encounter problems when using this apparatus, check the following points before requesting service. If the problem remains unsolved, go to the Philips web site ([www.philips.com/welcome](http://www.philips.com/welcome)). When you contact Philips, ensure that the apparatus is nearby and the model number and serial number are available.

### No power

- Ensure that the AC power plug of the unit is connected properly.
- Ensure that there is power at the AC outlet.
- To save power, the unit switches to standby automatically 15 minutes after a play reaches the end and no control is operated.

### No sound

- Adjust the volume.

### No response from the unit

- Disconnect and reconnect the AC power plug, then turn on the unit again.

### Remote control does not work

- Before pressing any function button, first select the correct source with the remote control instead of the main unit.
- Reduce the distance between the remote control and the unit.
- Insert the battery with its polarities (+/- signs) aligned as indicated.
- Replace the batteries.
- Aim the remote control directly at the sensor on the front of the unit.

### No disc detected

- Insert a disc.

- Check if the disc is inserted with the print side facing inward.
- Wait until the moisture condensation at the lens has cleared.
- Replace or clean the disc.
- Use a finalized CD or correct format disc.

### Cannot display some files in USB device

- The number of folders or files in the USB device has exceeded a certain limit. This phenomenon is not a malfunction.
- The formats of these files are not supported.

### USB device not supported

- The USB device is incompatible with the unit. Try another one.

### Poor radio reception

- Increase the distance between the unit and your TV or VCR.
- Fully extend and adjust the FM antenna.

### Timer does not work

- Set the clock correctly.
- Switch on the timer.

### Clock/timer setting erased

- Power has been interrupted or the power cord has been disconnected.
- Reset the clock/timer.

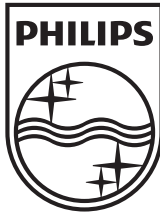

Specifications are subject to change without notice  
© 2012 Koninklijke Philips Electronics N.V.  
All rights reserved.

DCM1070\_UM\_12\_Book 1\_V1.4

