

Register your product and get support at

www.philips.com/welcome

DCB2020



User manual	3	Εγχειρίδιο χρήσης	101
Brugervejledning	27	Mode d'emploi	129
Benutzerhandbuch	51	Manuale utente	155
Käyttöopas	77	Gebruiksaanwijzing	181

PHILIPS

Contents

1 Important	4
Safety	4

2 Your Micro Music System	5
Introduction	5
What's in the box	5
Overview of the main unit	6
Overview of the remote control	7

3 Before use	9
Place the product	9
Connect speakers	9
Connect power	9
Install/replace the remote control batteries	9

4 Get started	10
Turn on	10
Set clock	11
Demonstrate features	11

5 Play	12
Play a disc	12
Play from a USB storage device	12
Basic control	12
Program audio tracks	12
Adjust sound	13

6 Play from iPod/iPhone/iPad	13
Compatible iPod/iPhone/iPad	13
Load the iPod/iPhone/iPad	13
Charge the iPod/iPhone/iPad	14
Listen to the iPod/iPhone/iPad	14
Remove the iPod/iPhone/iPad	15

7 Listen to radio	15
Store DAB radio stations automatically	15
Basic operations	16
Use the menu	16

8 Other features	17
Set sleep timer	17
Set alarm timer	17
Listen to external audio device	18
Listen through headphone	18

9 Upgrade the firmware	19
Register your product	19
Check the current firmware version	19
Perform the upgrade	19

10 Product information	20
Specifications	20
USB playability information	20
Supported MP3 disc formats	21
RDS program types	21

11 Troubleshooting	22
---------------------------	----

12 Notice	24
Compliance	24
Disposal of your old product and batteries	24
Copyright	24
Trademark	24

1 Important

Read and understand all instructions before you use this product. If damage is caused by failure to follow the instructions, the warranty does not apply.

Safety

Risk of electric shock!

- Never expose the product and accessories to rain or water; Never place liquid containers, such as vases, near the product. If liquids are split on or into the product, disconnect it from the power outlet immediately. Contact Philips Consumer Care to have the product checked before use.
- Never place the product and accessories near naked flames or other heat sources, including direct sunlight.
- Never insert objects into the ventilation slots or other openings on the product.
- Where the mains plug or an appliance coupler is used as the disconnect device, it shall remain readily operable.
- Disconnect the product from the power outlet before lightning storms.
- When you disconnect the power cord, always pull the plug, never the cable.

Risk of short circuit or fire!

- Before you connect the product to the power outlet, make sure that the power voltage matches the value printed on the back of the product.
- Avoid applying pressure on the power plugs. Loose power plugs can cause arcing or fire.

Risk of injury or damage to the product!

- To avoid exposure to laser radiation, do not disassemble.
- Do not touch the optical lens inside the disc compartment.

- Never place the product or any objects on power cords or on other electrical equipment.
- If the product is transported in temperatures below 5°C, unpack the product and wait until its temperature matches room temperature before connecting it to the power outlet.

Risk of overheating!

- Never install this product in a confined space. Always leave a space of at least four inches around the product for ventilation. Make sure that curtains or other objects never cover the ventilation slots on the product.

Risk of contamination!

- Remove the battery if flat or if the remote control is not to be used for a long time.
- Batteries contain chemical substances. They should be disposed of properly.

Hearing safety

Listen at a moderate volume.

- Using headphones at a high volume can impair your hearing. This product can produce sounds in decibel ranges that may cause hearing loss for a normal person, even for exposure less than a minute. The higher decibel ranges are offered for those that may have already experienced some hearing loss.
- Sound can be deceiving. Over time your hearing 'comfort level' adapts to higher volumes of sound. So after prolonged listening, what sounds 'normal' can actually be loud and harmful to your hearing. To guard against this, set your volume to a safe level before your hearing adapts and leave it there.

To establish a safe volume level:

- Set your volume control at a low setting.
- Slowly increase the sound until you can hear it comfortably and clearly, without distortion.

Listen for reasonable periods of time:

- Prolonged exposure to sound, even at normally 'safe' levels, can also cause hearing loss.
- Be sure to use your equipment reasonably and take appropriate breaks.

Be sure to observe the following guidelines when using your headphones.

- Listen at reasonable volumes for reasonable periods of time.
- Be careful not to adjust the volume as your hearing adapts.
- Do not turn up the volume so high that you can't hear what's around you.
- You should use caution or temporarily discontinue use in potentially hazardous situations.

 **Note**

- The type plate is located on the bottom of the product.

2 Your Micro Music System

Congratulations on your purchase, and welcome to Philips! To fully benefit from the support that Philips offers, register your product at www.philips.com/welcome.

Introduction

With this product, you can:

- enjoy audio from discs, USB storage devices, iPod, iPhone, iPad, and other external devices
- listen to radio stations

You can enrich sound output with these sound effects:

- Digital sound control (DSC)
- Dynamic bass boost (DBB)

The product supports these media formats:

What's in the box

Check and identify the contents of your package:

- Main unit
- Speaker X 2
- Rubber bumper for iPad 2
- Remote control (with two AAA batteries)
- User manual
- Quick start guide

Overview of the main unit

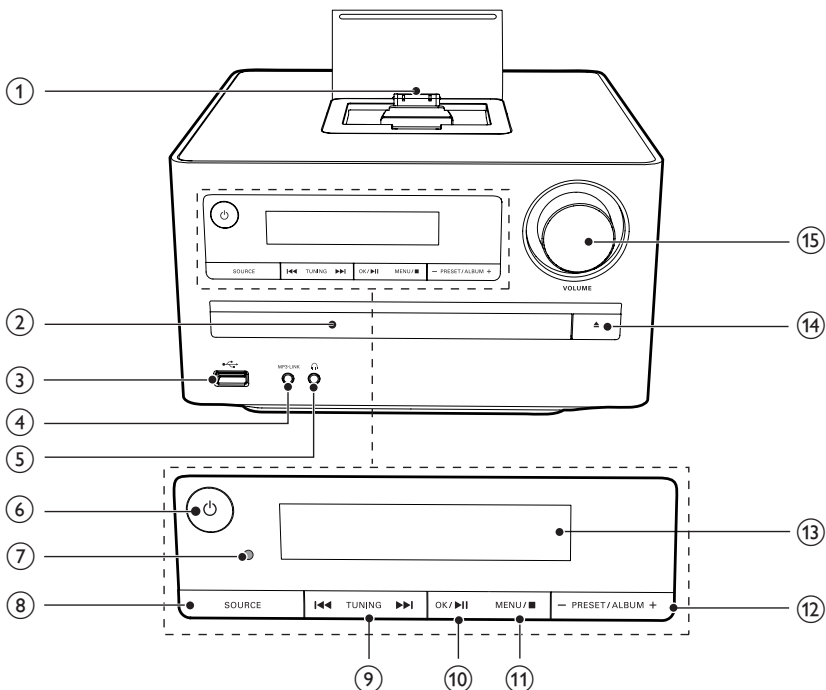

① Dock for iPod/iPhone/iPad

② Disc compartment

③  USB socket.

④ MP3-LINK
• Connect an external audio device.

⑤  Headphone socket.

⑥  Turn on the product.
• Switch to eco-power standby mode or normal standby mode.

⑦ IR sensor
• Receive signals from the remote control.

⑧ SOURCE
• Select a source.

⑨  Skip to the previous or next track.
• Press and hold to search within a track/disc.
• Tune to a radio station.

⑩  Start, pause, or resume play.
• In DAB or FM mode, confirm the menu option.
• In FM mode and with no menu option displayed, switch the sound mode between stereo and monophonic.

⑪  MENU / ■ Stop the play of music.
• Press twice to erase a program.

- In normal standby mode, turn on or off feature demonstration.
- In DAB or FM mode, access the menu.
- Access the playlist of iPod/iPhone.

12 - PRESET/ALBUM+

- Skip to the previous or next album.
- Select a preset radio station.
- Navigate through iPod/iPhone/iPad menu.

13 Display panel

- Display current status.

14 ▲

- Eject or close the disc tray.

15 VOLUME

- Adjust the volume level or time.

Overview of the remote control

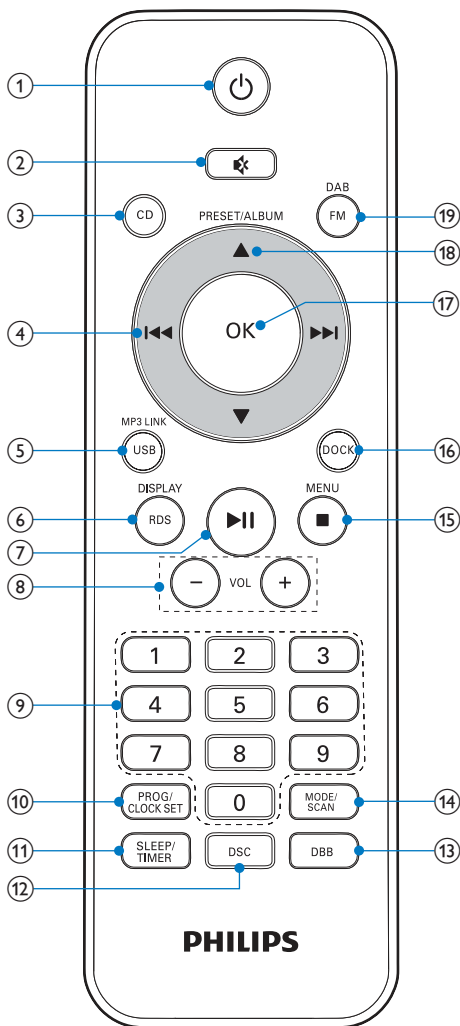

1 ①

- Turn on the product.
- Switch to eco-power standby mode or normal standby mode.

2 ②

- Mute or restore volume.

- ③ **CD**
- Select CD source.
- ④ **⏮ / ⏭**
- Skip to the previous or next track.
 - Press and hold to search within a track/disc.
 - Tune to a radio station.
- ⑤ **MP3 LINK/USB**
- Select MP3 LINK or USB source.
- ⑥ **RDS/DISPLAY**
- Synchronize the clock with an RDS radio station that transmits time signals.
 - Display the current status or media information.
 - Display available ID3 information of MP3 tracks.
 - When playing music from CD or USB storage device, display the clock.
- ⑦ **▶ ||**
- Start, pause, or resume play.
 - In DAB or FM mode, confirm the menu option.
- ⑧ **VOL +/-**
- Adjust the volume level or time.
- ⑨ **Numeric keypad**
- Enter numbers.
 - Enter the track number to select a track directly.
 - Enter the sequence number to select a preset radio station.
- ⑩ **PROG/CLOCK SET**
- Program audio tracks.
 - Program radio stations.
 - Set the clock.
- ⑪ **SLEEP/TIMER**
- Set the sleep timer or alarm timer.
- ⑫ **DSC**
- Select a preset sound setting.
- ⑬ **DBB**
- Turn on or off dynamic bass enhancement.
- ⑭ **MODE/SCAN**
- Select a play mode: normal play, repeat, or shuffle.
 - Search for available FM or DAB radio stations.
- ⑮ **■ /MENU**
- Stop the play of music.
 - Press twice to erase a program.
 - In normal standby mode, turn on or off feature demonstration.
 - In DAB or FM mode, access the menu.
 - Access the playlist of iPod/iPhone.
- ⑯ **DOCK**
- Select the dock source for iPod/iPhone/iPad.
- ⑰ **OK**
- In DAB or FM mode, confirm the menu option.
 - In FM mode and with no menu option displayed, switch the sound mode between stereo and monophonic.
 - After you select a file from the playlist of iPod/iPhone/iPad, press **OK** to start play.
- ⑱ **PRESET/ALBUM ▲ / ▼**
- Skip to the previous or next album.
 - Select a preset radio station.
 - Navigate through iPod/iPhone/iPad menu.
- ⑲ **DAB/FM**
- Select DAB or FM radio source.

3 Before use

Place the product

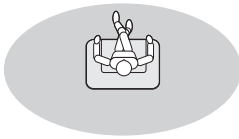

Place the speakers at an angle of approximately 45 degrees from the listening position.

Note

- To avoid magnetic interference or unwanted noise, never place this product too close to any radiation devices.

Connect speakers

Note

- Make sure that the colors of the speaker wires and terminals are matched.
- For optimal sound, use the supplied speakers only.
- Connect only speakers with impedance that is the same or higher than the supplied speakers. Refer to the chapter "**Specifications**" in this manual.

- 1 Hold down the socket flap.
- 2 Insert the stripped part of the wire completely.
 - Insert the right speaker wires to "R", left speaker wires to "L".

- Insert the red wires to "+", black wires to "-".

- 3 Release the socket flap.

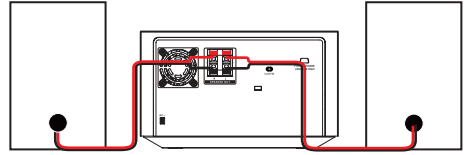

Connect power

! Caution

- Risk of product damage! Make sure that the power supply voltage corresponds to the voltage printed on the back or the underside of the product.
- Risk of electric shock! When you unplug the AC power cord, always pull the plug from the socket. Never pull the cord.
- Before you connect the AC power cord, make sure that you have completed all other connections.

Connect the power plug to the wall outlet.

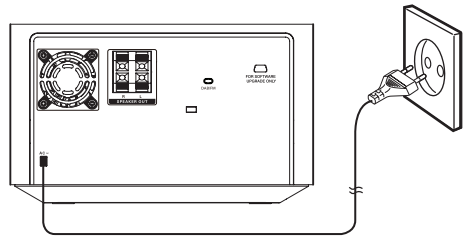

Install/replace the remote control batteries

! Caution

- Risk of explosion! Keep batteries away from heat, sunshine, or fire. Never discard batteries in fire.

- 1 Open the battery compartment.

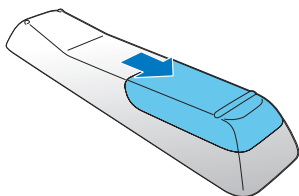

- 2 Insert 2 AAA batteries with correct polarity (+/-) as indicated.

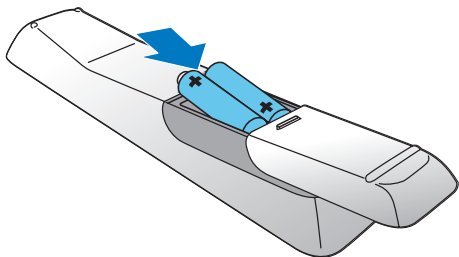

- 3 Close the battery compartment.

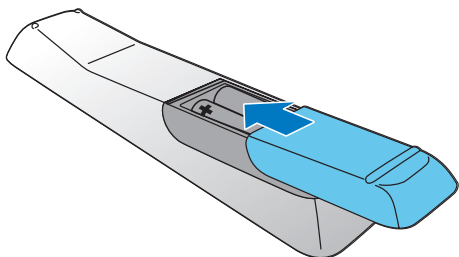

Note

- If you are not going to use the remote control for a long time, remove the batteries.
- Do not use old and new or different types of batteries in combination.
- Batteries contain chemical substances, so dispose of them properly.

4 Get started

! Caution

- Use of controls or adjustments or performance of procedures other than herein may result in hazardous radiation exposure or other unsafe operation.

Always follow the instructions in this chapter in sequence.

Turn on

Press ϕ .

- ↳ This product switches to the last selected source.

Switch modes

Automatically switch the modes:

- After this product keeps inactive for 15 minutes, it automatically switches to the normal standby mode.
- After this product keeps in the normal standby mode for 15 minutes, it automatically switches to the eco power standby mode.

Manually switch the modes:

- Press and hold ϕ to switch this product:
 - from the working mode or normal standby mode to the eco power standby mode.
 - from the eco power standby mode to the normal standby mode.
- Press ϕ to switch this product
 - between the working mode and a standby mode.

Note

- When an iPod/iPhone/iPad is connected, this product does not switch to the eco-power standby mode.

Set clock

- 1 In standby mode, press and hold **PROG/CLOCK SET** to activate clock setting.
 - ↳ **[CLOCK SET]** (set clock) scrolls on the display, and then **[CLOCK 24]** (24-hour time format) is displayed with "24" blinking.
- 2 Press **▲ / ▼** or **VOL +/-** to select **[CLOCK 24]** or **[CLOCK 12]** (12-hour time format), and then press **PROG/CLOCK SET**.
 - ↳ The hour digits begin to blink.
- 3 Press **▲ / ▼** or **VOL +/-** to set the hour.
- 4 Press **PROG/CLOCK SET** again.
 - ↳ The minute digits begin to blink.
- 5 Press **▲ / ▼** or **VOL +/-** to set the minute.
- 6 Press **PROG/CLOCK SET** to confirm the clock setting.
 - ↳ The set clock is displayed.
 - To exit clock setting without storing, press **■**.

Note

- If no button is pressed in 90 seconds, the system exits clock setting mode automatically.

Tip

- To adjust the digits of hour or minute, you can also turn the **VOLUME** knob or press **PRESET/ALBUM +/-** on the main unit.

Demonstrate features

- 1 In normal standby mode, press **■**.
 - **[WELCOME TO PHILIPS]** (welcome to Philips) scrolls on the display, and then feature names one by one.
- 2 To exit the feature demonstration, press **■** again.

5 Play

Play a disc

! Caution

- Risk of damage to the product! During play, never move the product.
- Never put any object other than a disc into the disc compartment.
- Never look at the laser beam inside the player.
- Never play discs with accessories such as disc stabilizer rings or disc treatment sheets.

- 1 Press **CD** to select the disc source.
- 2 Load a disc.
 - 1) Press **▲** to eject the disc tray.
 - 2) Place a disc onto the disc tray with its label facing up.
 - 3) Press **▲** to close the disc compartment.
- 3 Press **▶||** if the play does not start automatically.

Play from a USB storage device

This product can play files that are copied onto a supported USB storage device:

- flash drive
- memory card reader
- HDD (This product can only detect a portable hard disc drive with the peak current no higher than 500 mA through the USB socket.)

☰ Note

- Philips does not guarantee compatibility with all USB devices.
- NTFS (New Technology File System) data format is not supported.

- 1 Connect the USB storage device into the **↔ (USB)** socket.
- 2 Press **USB** to select the USB source.
↳ Play starts automatically.

If the play does not start automatically,

- 1 Press **PRESET/ALBUM ▲ / ▼** to select a folder.
- 2 Press **I◀◀ / ▶▶I** to select a file.
- 3 Press **▶||** to start the play.

Basic control

Buttons	Actions
▶ 	Start, pause, or resume play.
■	Stop play.
I◀◀ / ▶▶I	Skip to the previous or next file.
I◀◀ / ▶▶I	Press and hold to rewind or search forward.
MODE/SCAN	Select a play mode: normal play, repeat, or shuffle.
RDS/DISPLAY	Display the current status and media information.

Program audio tracks

- 1 Press **■** to stop the play.
- 2 Press **PROG/CLOCK SET**.
↳ **[PRG]** blinks on the display panel.
- 3 Press **I◀◀ / ▶▶I** to select a track number.
- 4 Press **PROG/CLOCK SET**.
- 5 Repeat steps 3 and 4 to program more tracks.
- 6 Press **▶||** to play the programmed tracks.
 - To erase the program, press **■** twice.

 Note

- The programmed tracks must be stored on the same disc or USB storage device.
- You can program a maximum of 20 tracks.

Adjust sound

During play, you can adjust the volume level and sound effect through following operations.

Button	Function
VOL +/-	Increase or decrease the volume.
	Mute or restore sound.
DBB	Turn on or off the dynamic bass enhancement (DBB). <ul style="list-style-type: none"> • If DBB is activated, [DBB] is displayed.
DSC	Select a sound effect: [POP] (pop), [JAZZ] (jazz), [ROCK] (rock), [CLASSIC] (classic), or [FLAT] (flat).

6 Play from iPod/iPhone/iPad

You can enjoy audio from iPod/iPhone/iPad through this product.

 Note

- No audio output from the headphone socket in this situation.

Compatible iPod/iPhone/iPad

This product supports the following iPod, iPhone and iPad models.

- iPad 2
- iPad
- iPhone 4
- iPhone 3GS
- iPhone 3G
- iPhone
- iPod touch (1st, 2nd, 3rd, and 4th generation)
- iPod nano (1st, 2nd, 3rd, 4th, 5th, and 6th generation)
- iPod classic
- iPod with video
- iPod with color display
- iPod mini

Load the iPod/iPhone/iPad

 Note

- The peak current through the dock connector is limited as 1000 mA for iPod/iPhone and 2100 mA for iPad/iPad 2. To avoid damage to your iPod/iPhone/iPad and this product, securely load your iPod/iPhone/iPad as indicated.

- 1 Push the lock key to release the dock lid.

- 2 Insert your iPod/iPhone/iPad onto the dock.

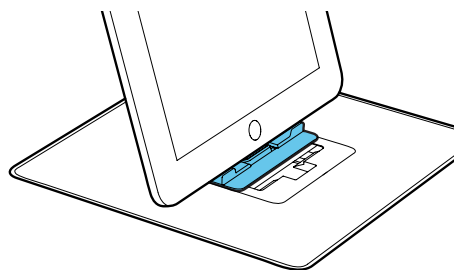
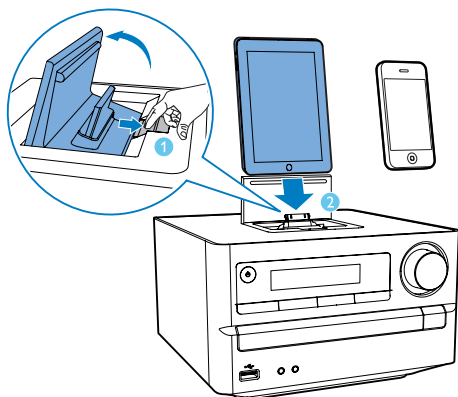

Charge the iPod/iPhone/iPad

When the product is connected to power, the docked iPod/iPhone/iPad starts charging automatically.



Tip

- For certain iPod models, it may take up to a minute before the charging indication appears.

Install the rubber bumper



Note

- If your iPad 2 is not in a case, use the supplied rubber bumper to keep it stable.

- 1 Release the dock lid, and then place the rubber bumper onto the dock compartment.

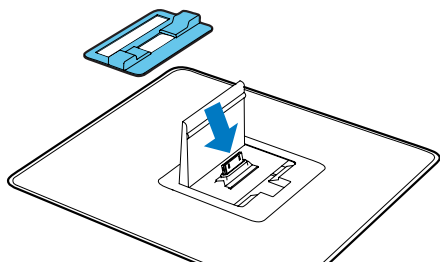

- 2 Load your iPad 2.



Note

- iPod with color display, iPod classic, and iPod with video are not compatible with dock charging.

Listen to the iPod/iPhone/iPad

- 1 Press **DOCK** to select the iPod/iPhone/iPad source.
- 2 Select and play a track on your iPod/iPhone/iPad.
 - To pause or resume the play, press **▶||**.
 - To skip to the previous or next track, press **◀◀ / ▶▶**.
 - To search during play, press and hold **◀◀ / ▶▶**, and then release it to resume normal play.
 - To access the playlist of iPod/iPhone, press **Menu/■**.

- To access the playlist of iPad/iPad 2, operate on the iPad/iPad 2 screen.
- To scroll through the playlist, press ▲ / ▼.
- To confirm an option, press **OK** on the remote control.

Remove the iPod/iPhone/iPad

- 1 Pull the iPod/iPhone/iPad out of the dock.
- 2 Flip down the lid to hide the dock.

7 Listen to radio



Note

- For optimal reception, fully extend the antenna and adjust its position, or connect an outdoor antenna.
- This product does not support MW (medium wave) radio reception.
- You can program a maximum of 30 DAB radio stations and 30 FM radio stations.
- Check with local retailer or go to www.WorldDAB.org for the applicable DAB radio frequencies in your area.
- Refer to "**Product information**" > "**RDS program types**" for more information about RDS radio stations.

Store DAB radio stations automatically

If no DAB radio station is stored, this product can search and store DAB radio stations automatically.

- 1 Press **DAB/FM** repeatedly to switch to the DAB mode.
 - ↳ **[FULL SCAN]** (full scan) is displayed.
- 2 Press **▶||** or **OK** to start the auto installation.
 - ↳ This product automatically stores radio stations with sufficient signal strength.
 - ↳ After all available radio stations are stored, the first stored radio station is broadcast automatically.

Basic operations

Follow the instructions below for more functions.

Tune to the next FM radio station with sufficient signal strength at the lower/higher frequency:

Press and hold **I◀◀ / ▶▶I** to start the auto search.

Tune to the FM radio station at a specific frequency:

Press **I◀◀ / ▶▶I** repeatedly until the frequency digitals are displayed.

Program FM radio stations automatically:

Press and hold **MODE/SCAN** or **PROG/CLOCK SET** to start the auto programming.

Program DAB radio stations automatically:

Press and hold **MODE/SCAN** to start the auto programming.

Program radio stations manually:

- 1) Tune to a radio station.
- 2) Press **PROG/CLOCK SET** to activate the programming.
- 3) Press **▲ / ▼** to assign a sequence number to the radio station.
- 4) Press **PROG/CLOCK SET** to confirm.
- 5) Repeat steps 1-4 to program more radio stations.

Tune to a preset radio station:

Press **▲ / ▼** repeatedly.

Switch the audio mode between [STEREO] (stereo) and [MONO] (monophonic) for FM radio:

Press **OK** repeatedly.

Display available information about the current radio station:

Press **RDS/DISPLAY** repeatedly.

Synchronize the clock with an RDS radio station:

- 1) Tune to an RDS radio station that transmits time signals.
 - 2) Press and hold **RDS/DISPLAY** until **[CT SYNC]** is displayed.
-

Use the menu

When you listen to radio, you can access the menu for control options.

- 1 Press **MENU/■**
 - ↳ FM mode: **[SCAN SETTINGS]** (scan setting) is displayed.
 - ↳ DAB mode: **[STATION]** (station) is displayed.

- 2 Press **I◀◀ / ▶▶I** to select a menu option, and then press **OK** or **▶▶I** to confirm the option or enter the lower-level menu.

FM mode:

[SCAN SETTINGS] (scan setting) Search and store radio stations automatically: **[STRONG]** (strong) for radio stations with strong signal only, **[ALL]** (all) for all radio stations.

[AUDIO] (audio) Select a sound mode: **[STEREO]** (stereo) or **[MONO]** (mono).

[SYSTEM] (system) **[RESET]** (reset): Reset all radio settings to the factory default status.

[SWVER] (software version): Display the current version of the firmware.

[UPGRADE] (upgrade): Upgrade the firmware.

DAB mode:

[STATION] (station) Access the list of the previously stored DAB radio stations.

- Press **I◀◀ / ▶▶I** to select a station, and then **▶▶I** to start listening.

[FULL SCAN] (full scan) Scan and store DAB radio stations within full range.

[MANUAL] (manual) Tune to a DAB radio station manually.

[DRC] (DRC) Dynamic range control: Select a level for the effect of dynamic range control.

[SYSTEM] (system)	[RESET] (reset): Reset all radio settings to the factory default status.
	[SWVER] (software version): Display the version of the current firmware.
	[UPGRADE] (upgrade): Upgrade the firmware.

- 3** Press **MENU/■** to exit the menu.

8 Other features

Set sleep timer

- In working mode, press **SLEEP/TIMER** repeatedly to select a set period (in minutes).
- ↳ When sleep timer is activated, **zZ** is displayed.
 - To deactivate sleep timer, press **SLEEP/TIMER** again until **zZ** disappears.

Set alarm timer

This product can be used as an alarm clock. You can select CD, iPod/iPhone/iPad library, PHILIPS playlist, FM/DAB, or USB as alarm source.



Note

- Make sure that you have set the clock correctly.

- 1** In standby mode, press and hold **SLEEP/TIMER** until **[TIMER SET]** (set timer) scrolls on the display.
↳ **[SELECT SOURCE]** (select source) scrolls on the screen.
- 2** Press **VOL +/-**, **SOURCE**, or **PRESET/ALBUM +/-** repeatedly to select a source: CD, USB, FM, DAB, iPod/iPhone/iPad library, or PHILIPS playlist.
- 3** Press **SLEEP/TIMER** to confirm.
↳ The hour digits are displayed and begin to blink.
- 4** Press **▲ / ▼** or **VOL +/-** repeatedly to set hour, and then press **SLEEP/TIMER**.
↳ The minute digits are displayed and begin to blink.

- 5 Press ▲ / ▼ or **VOL +/-** to set minute, and then press **SLEEP/TIMER** again.
↳ **[VOL]** (volume) is displayed and begins to blink.
- 6 Press ▲ / ▼ or **VOL +/-** to adjust volume, and then press **SLEEP/TIMER** to confirm.
↳  is displayed.
 - To deactivate/activate the alarm timer, press **SLEEP/TIMER** repeatedly in normal standby mode.

Note

- When the alarm sounds, you can press **VOL +/-** to adjust volume.
- The alarm timer is not available in MP3 LINK mode.
- To use iPod/iPhone/iPad playlist as the alarm source, create a playlist named "PHILIPS" in your iPod/iPhone/iPad first.
- If no playlist named "PHILIPS" exists in the iPod/iPhone/iPad or the playlist includes no playable track, this product switches the alarm source to iPod/iPhone/iPad library.
- If other alarm sources are unavailable, this product switches to FM mode automatically.

Listen through headphone

Plug a headphone into the  socket in the front panel of the main unit.

Note

- No audio output from the headphone socket when you listen to the docked iPod/iPhone/iPad. Listen through the speakers instead.

Listen to external audio device

You can listen to an external audio device, for example, MP3 player through this product.

- 1 Press **MP3 LINK/USB** repeatedly to select MP3 link source.
- 2 Connect the MP3 Link cable to
 - the **MP3-LINK** socket in the front panel of the main unit
 - the headphone socket on the external device.
- 3 Start to play the external device. (See the device user manual).

9 Upgrade the firmware

Note

- Power supply must not be interrupted during the upgrade.
- The firmware upgrade can only be available through the mini-USB port on the back plate.
- When the firmware upgrade succeeds, all settings are restored to the factory default status.

Register your product

- 1 Go to www.philips.com/welcome.
- 2 Click the link of "**Register my product**" (the exact wording of this link name may vary in different languages).
- 3 Login with your account on the prompt Web page.
 - If you have no account for Club Philips, create one first on this Web page.
- 4 Search your product with "**DCB2020/12**" as the keywords.
- 5 Click the link of search result to access the Web page for registering your product.
- 6 Fill in necessary information about this product to complete the registration.
 - ↳ With the registration, you can get information about software update and product support at this website or via your mailbox that is registered as the account for Club Philips.

Check the current firmware version

Follow the steps to check the current version of firmware on your product.

- 1 Press **DAB/FM** to switch to radio mode.
- 2 Press **MENU/■** to access the menu.
- 3 Press **I◀◀/▶▶I** to select **[SYSTEM]** (system).
- 4 Press **OK** or **▶▶**.
- 5 Press **I◀◀/▶▶I** to select **[SWVER]** (software version).
- 6 Press **OK** or **▶▶**.
 - ↳ The version of current firmware scrolls on the display panel

Perform the upgrade

- 1 Go to www.philips.com/welcome.
- 2 Login with your account for Club Philips.
 - ↳ Support information about your registered product is displayed.
- 3 Click the link of "**Firmware Upgrade Readme File**" (the exact wording of this link name may vary in different languages).
- 4 Read and understand the instructions on firmware upgrade.
- 5 Follow the instructions to download the upgrade packet and complete the upgrade.
 - If the upgrade fails, reconnect the power supply, turn on this product, and perform the upgrade again.

10 Product information

Note

- Product information is subject to change without prior notice.

Specifications

Amplifier

Rated Output Power	2 x 10 W RMS
Frequency Response	40 Hz-20 kHz, ± 3 dB
Signal to Noise Ratio	> 77 dB
MP3-Link Input	600 mV RMS 22 kohm

Disc

Laser Type	Semiconductor
Disc Diameter	12 cm/8 cm
Support Disc	CD-DA, CD-R, CD-RW, MP3-CD, WMA-CD
Audio DAC	24 Bits / 44.1 kHz
Total Harmonic Distortion	<0.8% (1 kHz)
Frequency Response	4 Hz - 20 kHz (44.1 kHz)
S/N Ratio	>75 dBA

Tuner (FM)

Tuning Range	87.5 - 108 MHz
Tuning grid	50 KHz
Sensitivity	
- Mono, 26dB S/N Ratio	< 22 dBf
- Stereo, 46dB S/N Ratio	< 43 dBf

Search Selectivity	> 28 dBf
Total Harmonic Distortion	< 2%
Signal to Noise Ratio	> 55 dB

DAB Tuner

Tuning Range	174–240 MHz (Band III)
Sensitivity	> 90 dBf

Speakers

Speaker Impedance	6 ohm
Speaker Driver	10 cm full range
Sensitivity	> 84 dB/m/W ± 4 dB/m/W

General information

AC power	220-240 V ~, 50/60 Hz
Operation Power Consumption	25 W
Power Consumption in Eco-power Standby	< 0.5 W
USB Direct	Version 2.0 HS
Dimensions - Main Unit (W x H x D)	200 x 118 x 210 mm
- Speaker Box (W x H x D)	140 x 224 x 144 mm
Weight - Main Unit	1.35 kg
- Speaker Box	1.05 kg x 2

USB playability information

Compatible USB devices:

- USB flash memory (USB 2.0 or USB1.1)
- USB flash players (USB 2.0 or USB1.1)
- memory cards (requires an additional card reader to work with this product)

Supported formats:

- USB or memory file format FAT12, FAT16, FAT32 (sector size: 512 bytes)
- MP3 bitrate (data rate): 32-320 Kbps and variable bitrate
- WMA v9 or earlier
- Directory nesting up to a maximum of 8 levels
- Number of albums/folders: maximum 99
- Number of tracks/files: maximum 999
- ID3 tag v2.0 or later
- File name in Unicode UTF8 (maximum length: 64 bytes)

Unsupported formats:

- Empty albums: an album that does not contain MP3/WMA files
- Unsupported file formats are skipped. For example, Word documents (.doc) or MP3 files with extension .dlf are ignored and not played.
- AAC, WAV, PCM audio files
- DRM protected WMA files (.wav, .m4a, .m4p, .mp4, .aac)
- WMA files in Lossless format

Supported MP3 disc formats

- ISO9660, Joliet
- Maximum track/file number: 999 (depending on file name length)
- Maximum album number: 99
- Supported sampling frequencies: 32 kHz, 44.1 kHz, 48 kHz
- Supported bitrates: 32-320 kbps, variable bitrates

RDS program types

NO TYPE	No RDS programme type
NEWS	News services
AFFAIRS	Politics and current affairs
INFO	Special information programs
SPORT	Sports
EDUCATE	Education and advanced training
DRAMA	Radio plays and literature
CULTURE	Culture, religion and society
SCIENCE	Science
VARIED	Entertainment programs
POP M	Pop music
ROCK M	Rock music
MOR M	Light music
LIGHT M	Light classical music
CLASSICS	Classical music
OTHER M	Special music programs
WEATHER	Weather
FINANCE	Finance
CHILDREN	Children's programs
SOCIAL	Social Affairs
RELIGION	Religion
PHONE IN	Phone In
TRAVEL	Travel
LEISURE	Leisure
JAZZ	Jazz Music
COUNTRY	Country Music
NATION M	National Music
OLDIES	Oldies Music
FOLK M	Folk Music
DOCUMENT	Documentary
TES	Alarm Test
ALARM	Alarm

11 Troubleshooting



Warning

- Never remove the casing of this device.

To keep the warranty valid, never try to repair the system yourself. If you encounter problems when using this device, check the following points before requesting service. If the problem remains unsolved, go to the Philips Web page (www.philips.com/support). When you contact Philips, make sure that the device is nearby and the model number and serial number are available.

Problem	Solution
No power	Make sure that the AC power cord is connected properly.
	Make sure that there is power at the AC outlet.
	With a power-saving feature, the system switches off automatically 15 minutes after the product stays inactivity.
No sound or poor sound	Adjust the volume.
	Disconnect the headphones.
	Make sure that the speakers are connected correctly.
	Make sure that the stripped speaker wires are clamped.
No response from the product	Reconnect the AC power plug, and then turn on the product again.
	With a power-saving feature, the system switches off automatically 15 minutes after the product stays inactivity.
Remote control does not work	Before you press any function button, select the correct source with the remote control instead of the main unit.
	Reduce the distance between the remote control and the main unit.
	Insert each battery with its polarity (+/- signs) aligned as indicated.
	Replace the batteries.
	Aim the remote control directly at the sensor on the front panel of the main unit.
No disc detected	Insert a disc.
	Make sure that you place the disc with its label facing upwards.
	Wait until the moisture condensation at the lens has cleared.
	Replace or clean the disc.
	Make sure that the recordable disc is finalized and the format supported.
USB storage device not supported	Make sure that the USB storage device is compatible with the product.
	Try another one.
Cannot play some files on the USB storage device	Make sure that the file format is supported.
	Make sure that the file quantity does not exceed the maximum.

Problem	Solution
Poor radio reception	Increase the distance between the product and other electrical appliances.
	Fully extend the antenna.
	Connect an outdoor FM/DAB antenna instead.
Timer does not work	Set the clock correctly.
	Switch on the timer.
Clock/timer setting erased	Power has been interrupted or the AC power cord has been disconnected.
	Reset the clock/timer.

12 Notice

Compliance



This product complies with the radio interference requirements of the European Community.

Disposal of your old product and batteries



Your product is designed and manufactured with high quality materials and components, which can be recycled and reused.



When this crossed-out wheeled bin symbol is attached to a product it means that the product is covered by the European Directive 2002/96/EC. Please inform yourself about the local separate collection system for electrical and electronic products.

Please act according to your local rules and do not dispose of your old products with your normal household waste.

Correct disposal of your old product helps to prevent potential negative consequences for the environment and human health.



Your product contains batteries covered by the European Directive 2006/66/EC, which cannot be disposed with normal household waste. Please inform yourself about the local rules on separate collection of batteries because correct disposal helps to prevent negative consequences for the environmental and human health.

Copyright



Be responsible
Respect copyrights

The making of unauthorized copies of copy-protected material, including computer programs, files, broadcasts and sound recordings, may be an infringement of copyrights and constitute a criminal offence. This equipment should not be used for such purposes.

Trademark

Made for



iPod



iPhone



iPad

"Made for iPod," "Made for iPhone," and "Made for iPad" mean that an electronic accessory has been designed to connect specifically to iPod, iPhone, or iPad, respectively, and has been certified by the developer to meet Apple performance standards. Apple is not responsible for the operation of this device or its compliance with safety and regulatory standards. Please note that the use of this accessory with iPod, iPhone, or iPad may affect wireless performance.

iPod and iPhone are trademarks of Apple Inc., registered in the U.S. and other countries. iPad is a trademark of Apple Inc.

This apparatus includes this label:



Norge

Typeskilt finnes på apparatens underside.

Observer: Nettbryteren er sekundert innkopleet. Den innebygde nettdelen er derfor ikke frakopleet nettet så lenge apparatet er tilsluttet nettkontakten.

For å redusere faren for brann eller elektrisk støt, skal apparatet ikke utsettes for regn eller fuktighet.



Specifications are subject to change without notice
© 2012 Koninklijke Philips Electronics N.V.
All rights reserved.

DCB2020_12_UM_V2.0

