

Quick Start Guide



Step A *Connect*

Step B *Setup*

Step C *Enjoy*

What's in the Box?

You should find these items upon opening the box.

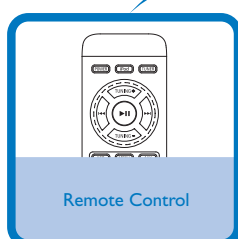
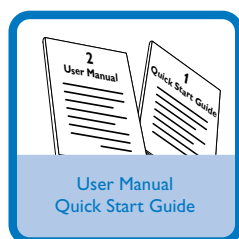

Pull out the plastic protective sheet before use.

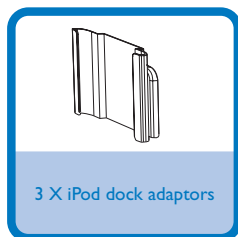
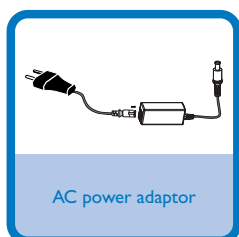
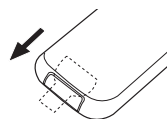

PHILIPS

Step A *Connect*

- 1 Connect the AC power adaptor of the system.

Tip

- See the User Manual for how to connect other equipment to this system.
- Use the supplied AC power adaptor only! Using any other power connection device may damage your main set!

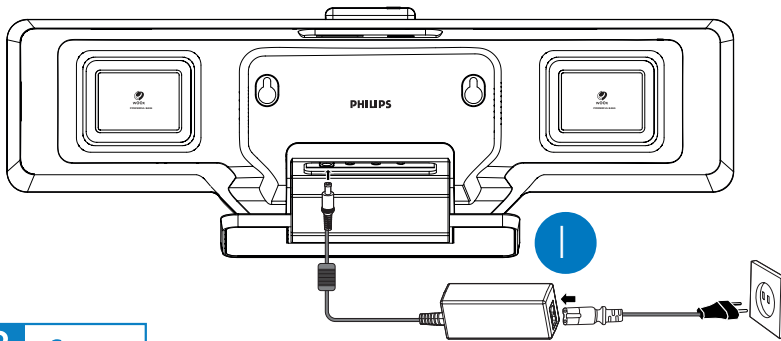

Step B *Setup*

Setting the clock

- 1 In standby mode, press and hold **PROG/SET TIME** on the remote control.
- 2 Press **VOLUME +/-** (or **VOL +/-** on the remote control) to switch between 12 hour and 24 hour display.
- 3 Press **PROG/SET TIME** on the remote control again to confirm.
→ The clock digits flash on the display panel.
- 4 Press **VOLUME +/-** (or **VOL +/-** on the remote control) to set the hours.
- 5 Press **PROG/SET TIME** on the remote control again.
→ The clock digits for the minutes flash.
- 6 Press **VOLUME +/-** (or **VOL +/-** on the remote control) to set the minutes.
- 7 Press **PROG/SET TIME** on the remote control to confirm the time.

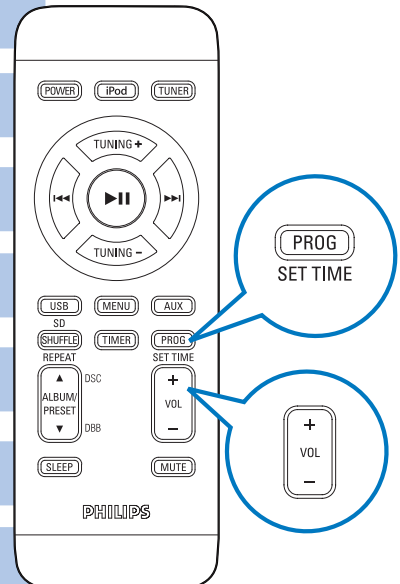

Programming and tuning to radio stations

1

Press **SOURCE** repeatedly (or **TUNER** on the remote control) to select the tuner source (FM).

2

Press **PROG** on the remote control for more than two seconds to program all available stations in order of waveband.

3

Press **PRESET +/-** (or **ALBUM/PRESET ▲ / ▼** on the remote control) until the desired preset station is displayed.

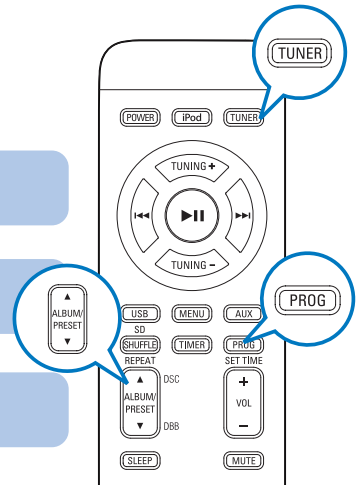

Playing a USB mass storage device/SD/IMMC card

With the Hi-Fi system, you can use USB flash memory (USB 2.0 or USB1.1), USB flash players (USB 2.0 or USB1.1) and memory cards





1

Insert the USB device's USB plug into the socket  or fully insert the SD/MMC card into the SD/MMC slot on the top of the system.

2

Press **SOURCE** once or more (or **USB/CARD** on the remote control) to select **USB/CARD**.

3

Play the available audio files using playback buttons on the set or remote control (such as    ).

Playing Apple iPod using DC910

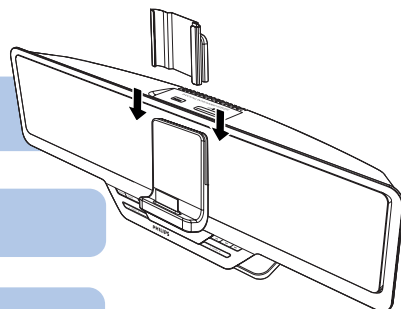

1 Select the correct dock adaptor, as indicated on each adaptor, then fit it in the dock.

2 Correctly place the compatible iPod player into the dock.

3 Press **SOURCE** on the system repeatedly or **iPod** on the remote control to select the iPod source.

4 Power on your iPod player.

5 Select and play your favourite songs stored in the iPod player.

Tip

Detailed playback features and additional functions are described in the accompany owner's manual.

Notes for remote control:

- First select the source you wish to control by pressing one of the source select keys on the remote control (for example iPod, TUNER).
- Then select the desired function (for example ► || , ◀◀ , ▶▶).

