

Docking Entertainment System

DC199
DC199B

Register your product and get support at

www.philips.com/welcome

User manual

Manuel d'utilisation

Manual de usuario

Benutzerhandbuch

Gebruikershandleiding

Manuale dell'utente

Användarhandbok

Brugervejledning

Käyttöopas

Manual do usuário

Εγχειρίδιο χρήσεως



PHILIPS

Important notes for users in the U.K.

Mains plug

This apparatus is fitted with an approved 13 Amp plug. To change a fuse in this type of plug, proceed as follows:

- 1 Remove fuse cover and fuse.
- 2 Fit new fuse, which should be a BS1362 3-Amp, A.S.T.A. or BSI approved type.
- 3 Refit the fuse cover.

If the fitted plug is not suitable for your socket outlets, it should be cut off and an appropriate plug fitted in its place.

If the mains plug contains a fuse, it should have a value of 3 Amp. If a plug without a fuse is used, the fuse at the distribution board should not be greater than 3 Amp.

Note: The severed plug must be disposed of to avoid a possible shock hazard should it be inserted into a 13-Amp socket elsewhere.

How to connect a plug

The wires in the mains lead are coloured with the following code: blue = neutral (N), brown = live (L).

- As these colours may not correspond with the colour markings identifying the terminals in your plug, proceed as follows:
 - Connect the blue wire to the terminal marked N or coloured black.
 - Connect the brown wire to the terminal marked L or coloured red.
 - Do not connect either wire to the earth terminal in the plug marked E (or $\frac{1}{2}$) or coloured green (or green and yellow).

Before replacing the plug cover, make certain that the cord grip is clamped over the sheath of the lead - not simply over the two wires.

Copyright in the U.K.

Recording and playback of material may require consent. See Copyright Act 1956 and The Performer's Protection Acts 1958 to 1972.

Italia

DICHIARAZIONE DI CONFORMITA'

Si dichiara che l'apparecchio DC199/DC199B Philips risponde alle prescrizioni dell'art. 2 comma 1 del D.M. 28 Agosto 1995 n. 548.

Fatto a Eindhoven

Philips Consumer Electronics
Philips, Glaslaan 2
5616 JB Eindhoven, The Netherlands

Norge

Typeskilt finnes på apparatens underside.

Observer: Nettbryteren er sekundert innkoplet. Den innebygde nettdelen er derfor ikke frakoplet nettet så lenge apparatet er tilsluttet nettkontakten.

For å redusere faren for brann eller elektrisk støt, skal apparatet ikke utsettes for regn eller fuktighet.

CAUTION

Use of controls or adjustments or performance of procedures other than herein may result in unsafe operation.

VAROITUS

Muiden kuin tässä esitettyjen toimintojen säädön tai asetusten muutto saattaa altistaa vaaralliselle säteilylle tai muille vaarallisille toiminnoille.

Front panel view

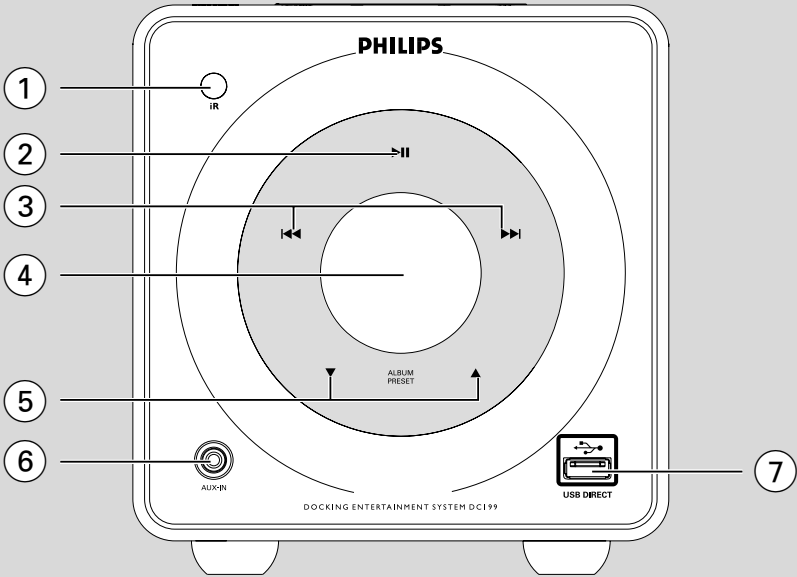

Top panel view

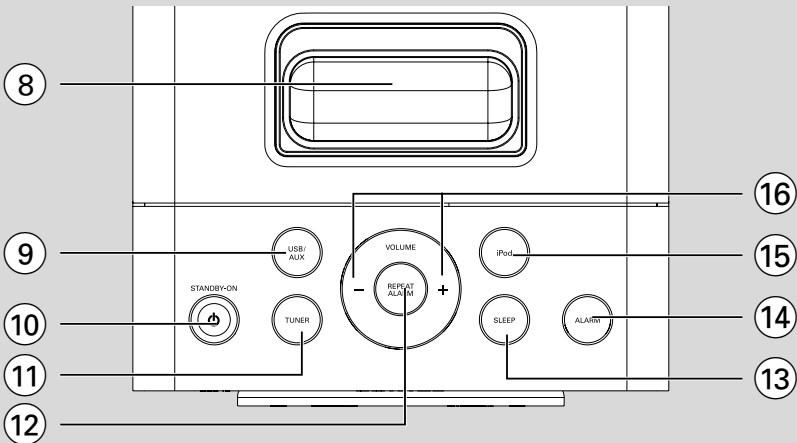

English 6

Français 22

Español 38

Deutsch 54

Nederlands 70

Italiano 86

Svenska 102

Dansk 118

Suomi 134

Português 150

Ελληνικά 166

English

Français

Español

Deutsch

Nederlands

Italiano

Svenska

Dansk

Suomi

Português

Ελληνικά

Contents

General Information

Environmental Information	7
Supplied accessories	7
Safety Information	7
Hearing Safety	7

Preparations

Rear connections	8
Connecting a USB device or memory card	9
Connecting other equipment to your system	9
Before using the remote control	9
Replacing the remote control battery	9

Controls

Main unit	10
Remote Control	11

Basic Functions

Switching the system on	12
Switching the system to standby mode	12
Power Saving Automatic Standby	12
Adjusting volume and sound	12
Adjusting the display backlight	12

USB playback functions

Different play modes: SHUFFLE and REPEAT	13
Programming track numbers	13
Erasing the program	13

Radio Reception

Tuning to radio stations	14
Programming radio stations	14
Automatic programming	14
Manual programming	14
Tuning to preset radio stations	14

External Sources

Using a non-USB device	15
Using a USB mass storage device	15

Clock/Sleep Timer

Clock setting	17
Setting the Alarm Time	17
Stopping the alarm	17
Sleep timer setting	17

iPod Dock

Compatible iPod players	19
Selecting the correct dock adaptor	19
Using the dock adaptors	19
Playing an iPod portable player	19
Charging iPod battery using the dock	19

Specifications

Troubleshooting

Congratulations on your purchase and welcome to Philips!

To fully benefit from the support that Philips offers, register your product at www.philips.com/welcome.

This product complies with the radio interference requirements of the European Community.

Environmental Information

All unnecessary packaging has been omitted. We have tried to make the packaging easy to separate into three materials: cardboard (box), polystyrene foam (buffer) and polyethylene (bags, protective foam sheet).

Your system consists of materials which can be recycled and reused if disassembled by a specialized company. Please observe the local regulations regarding the disposal of packaging materials, exhausted batteries and old equipment.

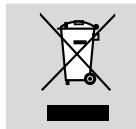

Disposal of your old product

Your product is designed and manufactured with high quality materials and components, which can be recycled and reused.

When this crossed-out wheeled bin symbol is attached to a product it means the product is covered by the European Directive 2002/96/EC.

Please inform yourself about the local separate collection system for electrical and electronic products.

Please act according to your local rules and do not dispose of your old products with your normal household waste. The correct disposal of your old product will help prevent potential negative consequences for the environment and human health.

Supplied accessories

- remote control (with battery)
- FM antenna
- 4 X iPod dock adaptors
- 1 X certified AC/DC adapter (Input: 100-240V ~ 50-60Hz 1.2 A, Output: 16V --- 2.8A)

Safety Information

- Before operating the system, check that the operating voltage indicated on the typeplate of your system is identical with the voltage of your local power supply. If not, please consult your dealer.
- Place the system on a flat, hard and stable surface.
- Place the system in a location with adequate ventilation to prevent internal heat build-up in your system. Allow at least 10 cm (4 inches) clearance from the rear and the top of the unit and 5 cm (2 inches) from each side.
- The ventilation should not be impeded by covering the ventilation openings with items, such as newspapers, table-cloths, curtains, etc.
- Do not expose the system, batteries or discs to excessive moisture, rain, sand or heat sources caused by heating equipment or direct sunlight.
- No naked flame sources, such as lighted candles, should be placed on the apparatus.
- No objects filled with liquids, such as vases, shall be placed on the apparatus.
- Install this unit near the AC outlet and where the AC power plug can be reached easily.
- The apparatus shall not be exposed to dripping or splashing.
- **When the system is switched to Standby mode, it is still consuming some power. To disconnect the system from the power supply completely, remove the AC power plug from the wall socket.**

Hearing Safety

To establish a safe volume level:

- Set your volume control at a low setting.
- Slowly increase the sound until you can hear it comfortably and clearly, without distortion.

Listen for reasonable periods of time:

- Prolonged exposure to sound, even at normally "safe" levels, can also cause hearing loss.
- Be sure to use your equipment reasonably and take appropriate breaks.

Preparations

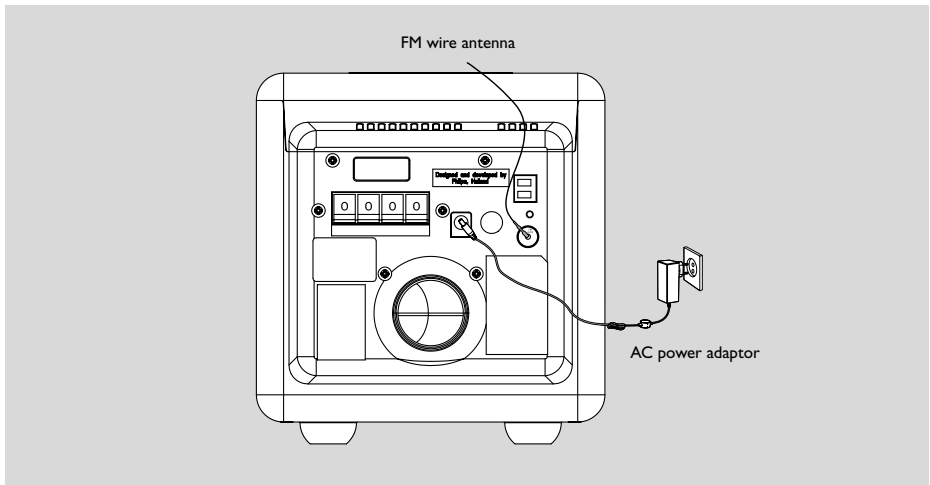

Rear connections

The type plate is located at the rear of the system.

For users in the U.K.: please follow the instructions on page 2.

A Power

- Before connecting the AC power adaptor to the wall outlet, ensure that all other connections have been made.

WARNING!

- For optimal performance, use only the original AC power adaptor.
- Never make or change connections with the power switched on.

To avoid overheating of the system, a safety circuit has been built in. Therefore, your system may switch to Standby mode automatically under extreme conditions. If this happens, let the system cool down before reusing it (not available for all versions).

B Antenna Connection

Connect the supplied FM antenna to the FM terminal. Extend and position the FM antenna for optimal reception.

Note:

- Position the FM antenna away from the speaker wires to avoid electrical interference.

C Speaker connections

Use the supplied speakers only. Using other speakers can damage the set or the sound quality will be negatively affected.

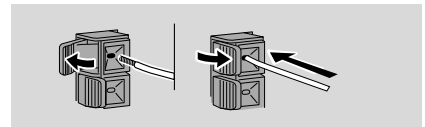

- Connect the cable of the left speaker to L (red and black) and the cable of the right speaker to R (red and black) as follows:
Press the clip of the red terminal and fully insert the stripped portion of the coloured (or marked) speaker cable into the socket, then release the clip.
Press the clip of the black terminal and fully insert the stripped portion of the black (or unmarked) speaker cable into the socket, then release the clip.

D Optional connections

The optional equipment and connecting cords are not supplied. Refer to the operating instructions of the connected equipment for details.

Connecting a USB device or memory card

By connecting a USB mass storage device (including USB flash memory, USB flash players or memory cards) to the system, you can enjoy the device's stored music through the powerful speakers of system.

- Insert the USB device's USB plug into the  socket on the set.

OR

for devices with USB cables:

- 1 Insert one plug of the USB cable (not supplied) to the  socket on the set.
- 2 Insert the other plug of the USB cable to the USB port of the USB device.

OR

for memory cards:

- 1 Insert the memory card into a card reader (not supplied).
- 2 Use a USB cable (not supplied) to connect the card reader into the  socket on the set.

Connecting other equipment to your system

- Use a line-in-cable to connect AUX IN to the analogue audio out terminals of an external equipment (TV, VCR, Laser Disc player, DVD player or CD Recorder).

Before using the remote control

Pull out the plastic protective sheet.

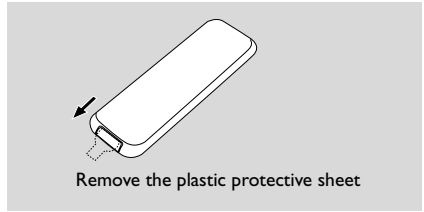

Replacing the remote control battery (lithium CR2025/CR2032)

- 1 Press the slot on the battery compartment.
- 2 Pull out the battery compartment.
- 3 Replace a new battery and fully insert the battery compartment back to the original position.

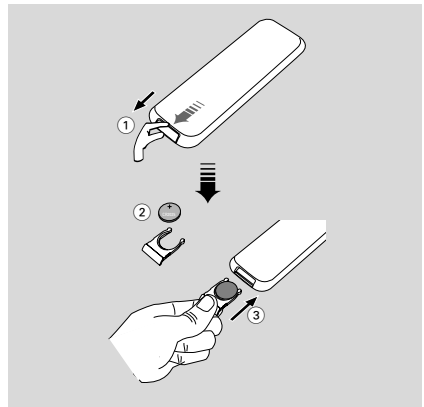

CAUTION!

Batteries contain chemical substances, so they should be disposed of properly.

Main unit

① IR

- remote sensor

② ► II

- (iPod/USB) starts or interrupts playback.

③ ◀◀/▶▶

iPod/ USB fast searches back and forward within a track (press and hold).
..... skips to the beginning of a current/previous/next track.

CLOCK adjusts the hours for the clock/ alarm function.

TUNER tunes to lower/ higher FM frequency.

④ Display screen

- shows the status of the system.

⑤ ALBUM/PRESET ▲ / ▼

- (USB) skips to the beginning of a previous/ subsequent album.
- adjusts the minutes for the clock/alarm function.
- selects a preset radio station.

⑥ AUX-IN

- connect an auxiliary device here.

⑦ USB DIRECT

- jack for the connecting an external USB mass storage device and MP3/ WMA players.

⑧ DOCK for iPod

- cradle for docking adaptors used to dock your iPod player for playback or recharging through this system.

⑨ USB/AUX

- selects sound source for a USB audio player/ other audio equipment.

⑩ STANDBY-ON

- switches on the system to the last sound source played.
- switches the system to standby mode.

⑪ TUNER

- selects the sound source for FM radio.

⑫ REPEAT ALARM

- stops an active alarm for a 9 minute interval.
- adjusts brightness control of the display screen backlight.

⑬ SLEEP

- selects the sleeper time.

⑭ ALARM

- activates/ deactivates alarm setting mode.
- turns alarm on/off

⑮ iPod

- selects the sound source for your iPod player.

⑯ VOLUME +/-

- adjusts the volume level.

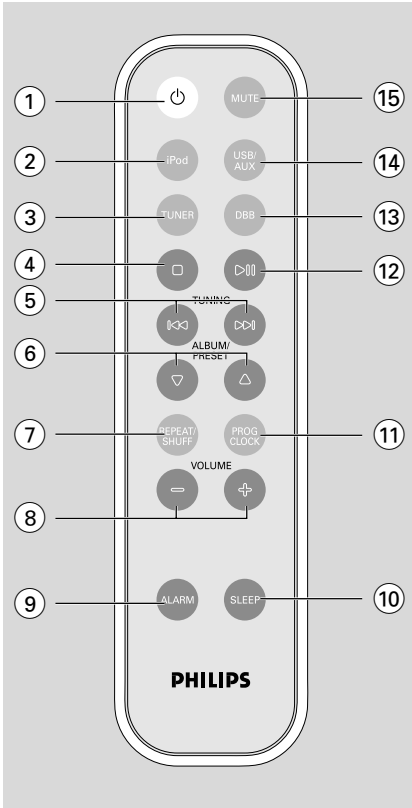

Remote Control

- ① **⏻**
 - switches on the system to the last sound source played.
 - switches the system to standby mode.
- ② **iPod**
 - selects the sound source for your iPod player.
- ③ **TUNER**
 - selects the sound source for FM radio.
- ④ **■** (USB devices only)
 - stops playback.
 - cancels programmed tracks.

- ⑤ **⏮ / ⏭**
 - iPod/USB.....fast searches back and forward within a track (press and hold).
 -skips to the beginning of a current/previous/next track.
- CLOCK**adjusts the hours for the clock/ alarm function.
- TUNER**tunes to lower/ higher FM frequency.

- ⑥ **ALBUM/PRESET ▲ / ▼**
 - (USB) skips to the beginning of a previous/ subsequent album.
 - adjusts the minutes for the clock/alarm function.
 - selects a preset radio station.

- ⑦ **REPEAT/SHUFF**
 - (USB) toggles track/album playback options e.g. repeat or random order mode.

- ⑧ **VOLUME +/-**
 - adjusts the volume level.

- ⑨ **ALARM**
 - activates/ deactivates alarm setting mode
 - turns alarm on/off

- ⑩ **SLEEP**
 - selects the sleeper time.

- ⑪ **PROG/CLOCK**
 - (TUNER) programs radio stations.
 - sets the clock function.
 - (USB) programs tracks.

- ⑫ **▶ ||**
 - (iPod/USB) starts or interrupts playback.

- ⑬ **DBB**
 - enhances the bass.

- ⑭ **USB/AUX**
 - selects sound source for a USB audio player/ other audio equipment.

- ⑮ **MUTE**
 - interrupts and resumes sound production.

Notes for remote control:



- **First select the source you wish to control by pressing one of the source select keys on the remote control (for example USB/AUX).**
- **Then select the desired function (for example ▶ ||, ⏮, ⏭).**





Important!

Before you operate the system, complete the preparation procedures.

Switching the system on

- Press **STANDBY-ON**  (or  on the remote control).
→ The system will switch to the last selected source.
- Press either **USB/AUX**, **iPod** or **TUNER** on the system /remote control.
→ The system will switch to the selected source.

Switching the system to standby mode

- Press **STANDBY-ON**  (or  on the remote control).
→ The volume level (up to a maximum volume level of 12), last selected mode, source and tuner presets will be retained in the system's memory.

Power Saving Automatic Standby

As a power-saving feature, the system automatically switches to standby 15 minutes after a USB connected device has reached the end of the last track and no control is operated.

Adjusting volume and sound

- 1 Press **VOLUME -/+** to decrease or increase the volume.
→ Display shows the volume level VoL and a number 0-32.
 - 2 Press **DBB** to switch bass enhancement on or off.
→ If the DBB is activated, **DBB** appears.
 - 3 Press **MUTE** on the remote control to interrupt sound reproduction instantly.
→ Playback will continue without sound and **MUTE** appears.
- To activate sound reproduction you can:
 - press **MUTE** again;
 - adjust the volume controls;
 - change source.

Adjusting the display backlight

During playback or standby mode, press **REPEAT ALARM** once or more to toggle between **BRIGHT** → **MEDIUM** → **OFF**.

USB playback functions



Different play modes: SHUFFLE and REPEAT

You can select and change the various play modes before or during playback. The REPEAT modes can also be combined with PROGRAM.

- To select your play mode, press **REPEAT/SHUFF** before or during playback until the display shows the desired function.
 - **SHUFF** appears if shuffle playback is activated and disappears if deactivated.
 - If **rREP onE** appears the current track will play repeatedly.
 - If **rREP ALL** appears all tracks will be played repeatedly.
 - If both **rREP** and **ALB** appears the current album will play repeatedly.

- To return to normal playback, press the **REPEAT/SHUFF** until **oFF** displayed.
- You can also press **■** to stop playback and cancel your play mode.

Note:

- The Repeat and Shuffle functions cannot be combined.

Programming track numbers

Program in the STOP position to select and store up to 20 tracks in the memory.

- Press **PROG/CLOCK** on the remote control to enter the programming mode.
 - **Pr 01** appears and **PROG** flashes.
- Press **◀▶▶▶** to select your desired track number.
- For tracks in a different album, press **ALBUM/PRESET ▲▼** to select a desired album number.
- Press **PROG/CLOCK** to confirm the track number to be stored.
- Repeat steps 2-3 to select and store all desired tracks.
 - **F L L L** appears if you attempt to program more than 20 tracks.
- To start playback of your program, press **▶ II**.

Erasing the program

You can erase the program by:

- pressing **■** once in the STOP mode;
- pressing **■** twice during playback;
 - **PROG** disappears.

Radio Reception



Tuning to radio stations

- 1 Press **TUNER** to select the tuner source.
- 2 Hold **◀◀/▶▶** and then release the button.
→ The system will start searching for a radio station with sufficient signal strength.
- 3 Repeat step 2 if necessary until you find the desired station.
- To tune to a weak station, press **◀◀/▶▶** briefly and repeatedly.

Programming radio stations

You can store up to a total of 20 radio stations in the memory.

Automatic programming

Automatic programming will start at preset number 1 and all your former presets will be overridden.

- Press **PROG/ CLOCK** for more than 3 seconds to activate programming.
→ All available stations are programmed.

Manual programming

- 1 Tune to your desired station (refer to "Tuning to radio stations").
- 2 Press **PROG/CLOCK** to activate programming.
→ **PROG** flashes in the display.
- 3 Press **ALBUM/PRESET ▲ ▼** to allocate a number from 1 to 20 to this station.
- 4 Press **PROG/CLOCK** again to confirm the setting.
→ **PROG** disappears, the preset number and the frequency of the preset station are shown.
- 5 Repeat the above four steps to store other stations.
- You can override a preset station by storing another frequency in its place.

Tuning to preset radio stations

- Press **ALBUM/PRESET ▲ / ▼** until the desired preset station is displayed.

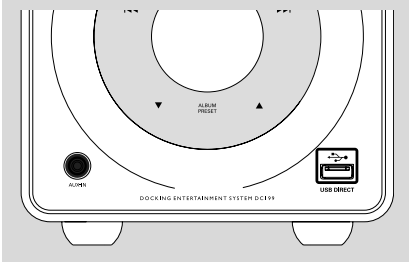

Using a non-USB device

- 1 Connect the audio out terminals of the external equipment (TV, VCR, Laser Disc player, DVD player or CD Recorder) to the AUX IN socket of your system.
- 2 Press **USB/AUX** to select external equipment.

Note:

– Refer to the operating instructions of your connected equipment for details.



Using a USB mass storage device

By connecting a USB mass storage device to the system, you can enjoy the device's stored music through the system's powerful speakers.

- 1 Check the USB device has been properly connected. (See Installation: Connecting an additional appliance).
- 2 Press **USB/AUX** once or more to select USB.
 - **no AUDIO** appears if no audio file is found in the USB device.
- 3 Refer to the Quick Start Guide or the Controls page of this manual for basic playback features.

Playing a USB mass storage device Compatible USB mass storage devices

You can use:

- USB flash memory (USB 2.0 or USB1.1)
- USB flash players (USB 2.0 or USB1.1)
- memory cards (requires an additional card reader)

INFORMATION REGARDING USB DIRECT:

1. *Compatibility of the USB connection on this system:*

a) *This product supports most USB Mass storage devices (MSD) that are compliant to the USB MSD standards.*

- i) *Most common Mass storage class devices are flash drives, memory sticks, jump drives and etc.*
- ii) *If you see a "Disc Drive" showing up on your computer after you have plugged the mass storage device into your computer, most likely it is MSD compliant and it will work with this system.*

b) *If your Mass storage device requires a battery/ power source please make sure you have a fresh battery inserted or charge the USB device before connecting to the system.*

2. *Supported Music type:*

a) *This device only supports unprotected music with the following file extension:*

.mp3

.wma

b) *Music bought from on-line music stores are not supported because they are secured by Digital Rights Management protection (DRM).*

c) *File name extensions that end with the following are not supported:*

.wav; .m4a; .m4p; mp4; .aac and etc.

3. *Playback of audio files through the system's speakers is not possible if you connect directly from your computer to the USB socket.*

Supported formats:

- USB or memory file format FAT12, FAT16, FAT32 (sector size: 512-4096 bytes)
- MP3 bit rate (data rate): 32-320 Kbps and variable bit rate
- WMA v9 or earlier
- Directory nesting up to a maximum of 8 levels
- Number of albums/ folders: maximum 99
- Number of tracks/titles: maximum 999
- ID3 tag v2.0 or later
- File name in Unicode UTF8 (maximum length: 128 bytes)

The system will not play or support the following:

- Empty albums: an empty album is an album that does not contain MP3/WMA files, and will not be shown in the display.
- Non-supported file formats are skipped. This means that e.g.: Word documents .doc or MP3 files with extension .dlf are ignored and will not be played.
- AAC, WAV, PCM audio files
- DRM protected WMA files
- WMA files in Lossless format.

Clock/Sleep Timer

Note:

– If you press **SLEEP** again, this will change your sleep time period to the next shorter preset option.

To deactivate the sleep timer

- Press **SLEEP** repeatedly until "OFF" is displayed, or press **STANDBY ON** .

Compatible iPod players

- The docking entertainment system is compatible with all the existing Apple iPod models with 30-pin connector.

Selecting the correct dock adaptor

- Four adapters are included to fit different iPod models including iPod touch (8GB, 16GB), iPod classic (80GB, 160GB), iPod nano 3rd generation (4GB, 8GB), iPod the 5th generation (30GB, 60GB, 80GB), iPod nano 2nd generation (2GB, 4GB, 8GB) and iPod nano 1st generation (1GB, 2GB, 4GB).

Using the dock adaptors

- Before plugging your player in the dock, snap the suitable dock adaptor into the dock to provide a snug fit for the player to be docked.

Playing an iPod portable player

- 1 Correctly dock your iPod portable player in the cradle. Make sure the dock adaptor is compatible.
- Make sure that you have powered on your iPod player before selecting iPod source.
- 2 Press **iPod** on the remote control to select iPod source.
→ The iPod dock icon  appears.
- 3 Playback starts automatically. Playback functions play, skip, fast search and, pause are possible using the controls on this system and its remote control.

Charging iPod battery using the dock

- In iPod mode, directly dock your iPod portable player on the cradle for charging.

Note:

– *For the purpose of SAVING POWER, recharging of your USB device is NOT SUPPORTED when the main set is in the STANDBY MODE.*

Specifications

AMPLIFIER

Output power
..... 2 x 7.5W (satellite), 15W (sub-woofer)
Signal-to-noise ratio ≥ 70 dBA
Frequency response 50 Hz – 20 KHz, ± 3 dB
Input sensitivity AUX 0.5 V (max. 2 V)
Impedance loudspeakers
..... 4 Ω (satellite), 8 Ω (sub-woofer)

TUNER

FM wave range 87.5 – 108 MHz
Sensitivity at 75 Ω
– FM 20dBf
Selectivity ≥ 25 dB
Total harmonic distortion $\leq 1\%$
Frequency response
– FM 63 – 6000 Hz
Signal-to-noise-ratio
– FM ≥ 50 dBA

USB PLAYER

USB 12Mb/s, V1.1
..... support MP3 and WMA files
Number of albums/folders maximum 99
Number of tracks/titles maximum 999

GENERAL INFORMATION

AC Power 100 – 240 V / 50-60 Hz
Dimensions (w x h x d) 160 x 171 x 257.7 (mm)
Weight (with/ without speakers) 2.5/1.8 kg
Standby power consumption <7 W

Specifications and external appearance are subject to change without notice.

WARNING

Under no circumstances should you try to repair the system yourself, as this will invalidate the warranty. Do not open the system as there is a risk of electric shock.

If a fault occurs, first check the points listed below before taking the system for repair. If you are unable to remedy a problem by following these hints, consult your dealer or Philips for help.

Problem	Solution
“NO USB” is displayed.	<ul style="list-style-type: none"> ✓ Insert a a USB device.
Radio reception is poor.	<ul style="list-style-type: none"> ✓ If the signal is too weak, adjust the antenna or connect an external antenna for better reception. ✓ Increase the distance between the unit and your TV or VCR. ✓ Position the FM antenna away from the speaker wires to avoid electrical interference.
The system does not react when buttons are pressed.	<ul style="list-style-type: none"> ✓ Remove and reconnect the AC power plug and switch on the system again.
Sound cannot be heard or is of poor quality.	<ul style="list-style-type: none"> ✓ Adjust the volume. ✓ Disconnect the headphone.
The remote control does not function properly.	<ul style="list-style-type: none"> ✓ Select the source (e.g.TUNER) before pressing the function button (▲/▼, ◀◀/▶▶). ✓ Reduce the distance between the remote control and the system. ✓ Insert the battery with its polarities (+/- signs) aligned as indicated. ✓ Replace the battery. ✓ Point the remote control directly toward IR sensor on the front of the system.
The alarm function is not working.	<ul style="list-style-type: none"> ✓ Set the clock time correctly. ✓ Switch on the alarm.
The Clock setting is erased.	<ul style="list-style-type: none"> ✓ Power has been interrupted or the power cord has been disconnected. Reset the clock.