

Quick Start Guide



Step A *Connect*

Step B *Setup*

Step C *Enjoy*

What's in the Box?

You should find these items upon opening the box.

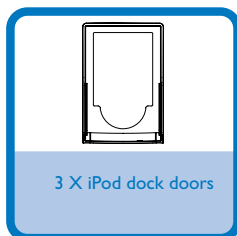
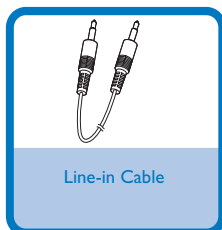
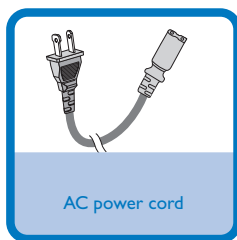
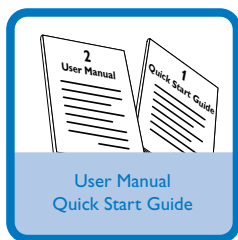

Step A **Connect**

- 1 Connect the AC power cable of the system.

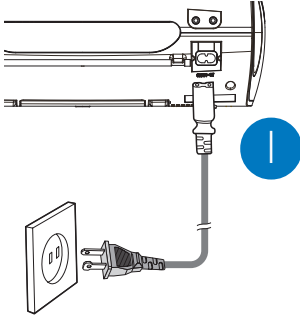

Tip

- See the User Manual for how to connect other equipment to this system.
- Use the supplied AC power cable only! Using any other power connection device may damage your main set!

Step B **Setup**

Before plugging your player in the dock, select a suitable dock door.

3 iPod dock doors are included. Each door has indication to match different iPod types.

- 2 Push the dock to eject it.

- 3 Turn the wheel of the dock support to adjust the height to different iPod types.

- 4 Align the slots of the dock and latches of the dock door, then slide in the door.

- 5 Align the connectors of on the dock and iPod, and then push the iPod gently to install your iPod to the dock connector.

- 6 To take out the iPod, push the dock to eject it.

- 7 Hold the iPod carefully and pull it out slowly.

- 8 Push the dock door to close it.

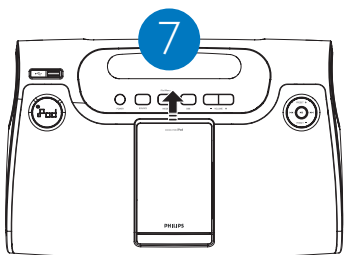
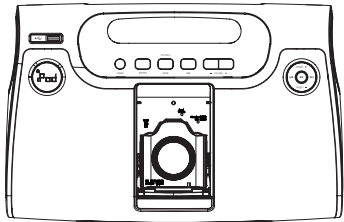
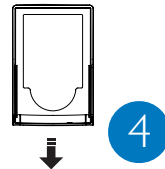
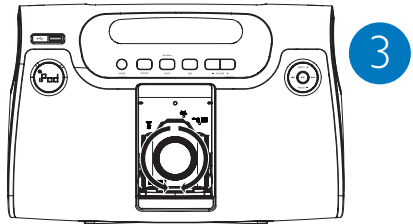
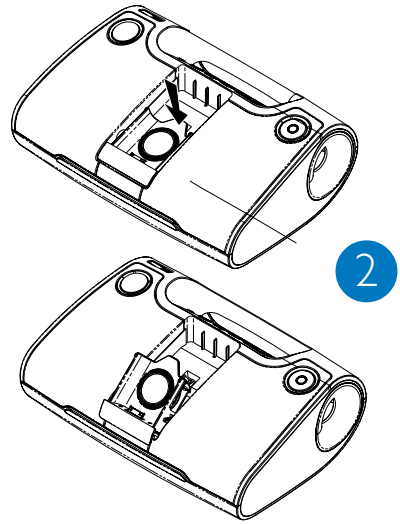







Programming and tuning to radio stations

- 1 Press **SOURCE** repeatedly to select the tuner source (FM).
- 2 Press **MODE** for more than two seconds to program all available stations in order of waveband.
- 3 Press **PRESET +/-** until the desired preset station is displayed.

Playing a USB mass storage device

With the Hi-Fi system, you can use USB flash memory (USB 2.0 or USB1.1), USB flash players (USB 2.0 or USB1.1)

- 1 Insert the USB device's USB plug into the socket  on the top of the system.
- 2 Press **SOURCE** repeatedly to select **USB**.
- 3 Play the available audio files using playback buttons on the set (such as     ).

Playing Apple iPod using DC185

1

Correctly place the compatible iPod player into the dock.

2

Press **SOURCE** on the system repeatedly to select the iPod source.

3

Power on your iPod player.

4

Select and play your favourite songs stored in the iPod player.

Note:

Some keys on DC185 correspond to different keys of an iPod. For detailed functions in different modes, please see the table in supplied user manual.

Tip

Detailed playback features and additional functions are described in the accompany owner's manual.

Notes for remote control:

- Select the source you wish to control by pressing one of the source select keys on the remote control (for example iPod, TUNER).
- Then select the desired function (for example ► ||).

