

■ MOUNTING LOCATION / UBICACIÓN PARA EL MONTAJE

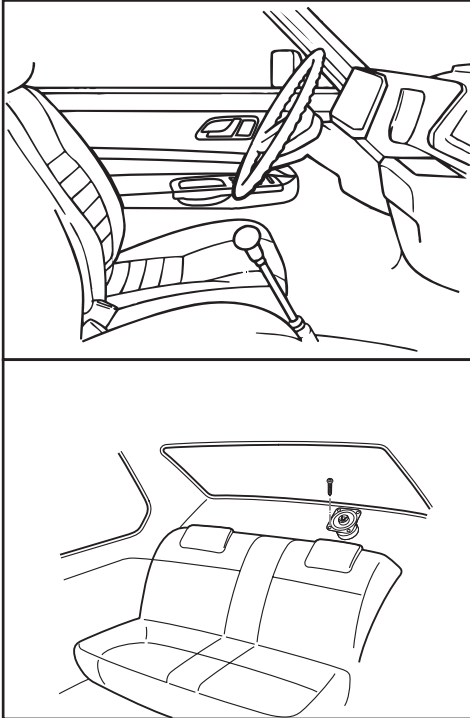

■ INSTALLATION / INSTALACIÓN

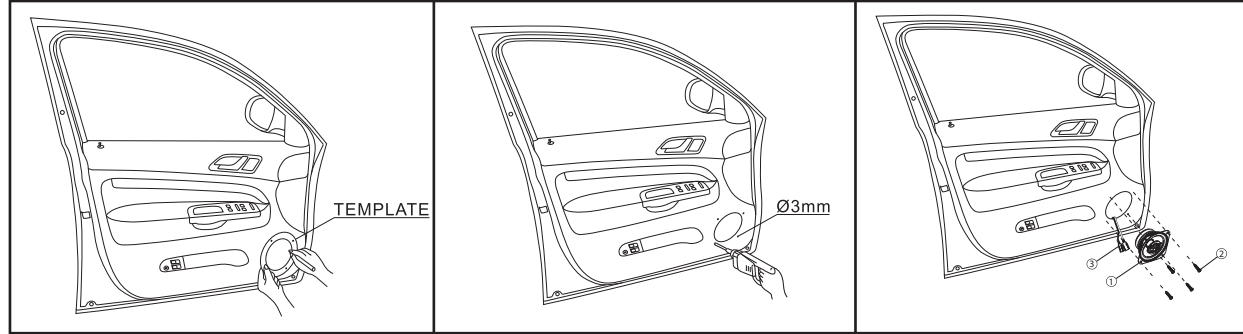

■ ACCESSORIES / ACCESORIOS

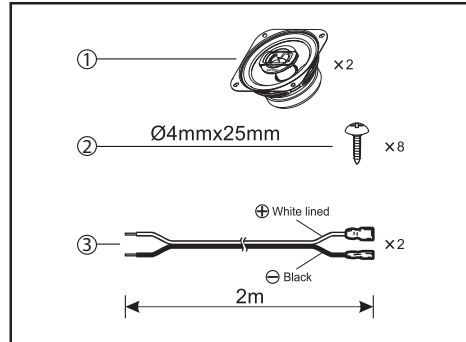

■ CONNECTION / CONEXIÓN

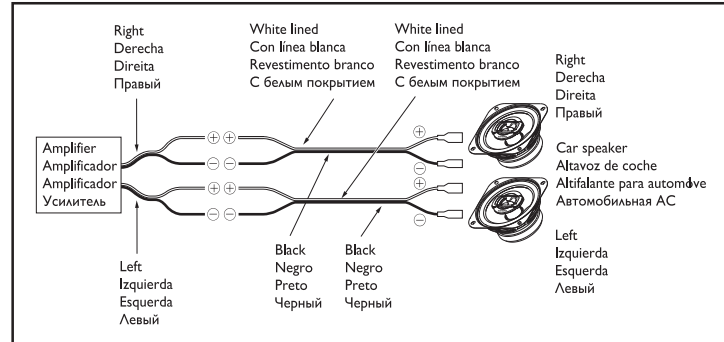

Speaker type.....10cm 2-Way Coaxial Speaker
 RMS power (Watts).....20W
 Peak music power (Watts).....110W
 Sensitivity (dB/W/m).....86dB
 Frequency response (Hz).....45-28kHz
 Impedance (Ohms).....4 Ohms
 Magnet mass (Oz).....3.6 Oz

Tipo de alto-falante.....Alto-falante coaxialbidireccional de 10 cm
 Potência em RMS (Watts).....20W
 Potência de pico musical (Watts).....110W
 Sensibilidade (dB/W/m).....86dB
 Resposta de freqüência (Hz).....45-28kHz
 Impedância (ohms).....4 Ohms
 Massa magnética (g).....102g