

Audio CD Recorder

**CDR950/951**

- *Instructions for use*
- *Mode d'emploi*
- *Instrucciones de manejo*
- *Bedienungsanleitung*
- *Gebruiksaanwijzing*
- *Istruzioni per l'uso*
- *Brugsanvisning*
- *Bruksanvisning*
- *Käyttöohje*
- *Manual de utilização*
- *Οδηγίες χρήσεως*
- *Instrukcja obsługi*



*Let's make things better.*



**PHILIPS**

# GENERAL INFORMATION

## DK

### Advarsel:

Usynlig laserudstråling ved åbning når sikkerhedsafbrydere er ude af funktion. Undgå udsættelse for stråling.

## S

### Varning!

Om apparaten används på annat sätt än i denna bruksanvisning specificerats, kann användaren utsättas för osynlig laserstråling, som överskrider gränsen för läserklass 1.

## SF

### Varoitus!

Laitteen käyttäminen muulla kuin tässä käyttöohjeessa mainitulla tavalla saattaa altistaa käyttäjän turvallisuusluokan 1 ylittävälle näkymättömälle lasersäteilille.

## LASER SAFETY

This unit employs a laser. Only a qualified service person should remove the cover or attempt to service this device, due to possible eye injury.

**USE OF CONTROLS OR ADJUSTMENTS OR PERFORMANCE OF PROCEDURES OTHER THAN THOSE SPECIFIED HEREIN MAY RESULT IN HAZARDOUS RADIATION EXPOSURE OR OTHER UNSAFE OPERATION.**

**NEVER MAKE OR CHANGE CONNECTIONS WITH THE POWER SWITCHED ON.**



The CDR950/951 is in conformity with the EMC directive and low-voltage directive.

## LASER

Type	Semiconductor laser GaAIAs
Wave length	775~795 nm (at 25° C)
Output Power	2,5 mW (Read) 35 mW (Write)
Beam divergence	60 degree.

### NOTE: THIS WARNING IS LOCATED INSIDE THE ENCLOSURE

<b>CAUTION</b>	INVISIBLE LASER RADIATION WHEN OPEN AVOID EXPOSURE TO BEAM
<b>VARO!</b>	AVATTAESSA OLET ALTIINA NÄKYMÄTTÖMÄLLE LASER SÄTTEILYLLE ÄLÄ KATSO SÄTTEESEN
<b>WARNING</b>	OSYNLIG LASERSTRÅLNING NÄR DENNA DEL ÄR ÖPPNAD BETRakta EJ STRÅLEN
<b>ADVERSEL</b>	USYNLIG LASERSTRÅLING VED ÅBNING. UNDGA UNSAETTELSE FOR STRÅLING
<b>DANGER</b>	INVISIBLE LASER RADIATION WHEN OPEN AVOID DIRECT EXPOSURE TO BEAM
<b>VORSICHT</b>	UNSICHTBARE LASERSTRAHLUNG WENN ABDECKUNG GEÖFFNET NICHT DEM STRAHL AUSSETSEN

**CLASS 1  
LASER PRODUCT**

**LUOKAN I  
LASERLAITE**

**KLASS 1  
LASERAPPARAT**

### For Customer Use:

Read carefully the information located at the back plate of your CD recorder/player and enter below the Serial N°.  
Retain this information for future reference.

Model N° .....CDR950/951.....

Serial N° .....

## CONTENTS

English .....	5	<b>English</b>
Français.....	27	<b>Français</b>
Español .....	51	<b>Español</b>
Deutsch.....	73	<b>Deutsch</b>
Nederlands .....	97	<b>Nederlands</b>
Italiano.....	119	<b>Italiano</b>
Svenska.....	141	<b>Svenska</b>
Dansk .....	163	<b>Dansk</b>
Suomi.....	185	<b>Suomi</b>
Português.....	207	<b>Português</b>
Έλληνικά .....	229	<b>Ελληνικά</b>
Polski.....	251	<b>Polski</b>

## Table of contents

### GENERAL INFORMATION AND DISCS

Welcome .....	6
About this manual.....	6
Technical data .....	6
Discs for recording.....	7
Discs for playback.....	7
Maintenance .....	7
Accessories .....	7

### CONTROLS AND CONNECTIONS

Controls on the front.....	8
Connections at the back .....	8

### DISPLAY

DISPLAY indications.....	9
DISPLAY messages .....	9
MENU messages.....	10

### INSTALLATION

Connections general .....	11
Analog connections .....	11
Digital coaxial connections .....	12
Digital optical connections .....	12
Power supply.....	13
Setup recommendations.....	13
Inserting batteries in the remote control .....	13

### REMOTE CONTROL

Remote control commands .....	14
Inserting discs .....	14

### RECORDING

Remarks about recording .....	15
Recording modes.....	15
Autostart recording .....	16
Manual recording.....	17
Microphone recording.....	18
Sample rate convertor (Monitor mode).....	18
Finalizing CDR & CDRW discs .....	19
Unfinalizing CDRW discs .....	19
Erasing CDRW discs .....	20

### PLAYING

Playing a CD .....	21
Selecting a track .....	21
Search .....	21
Shuffle (random order) play .....	21
Repeat CD, track or program .....	22

### PROGRAMMING

Remarks about programming.....	22
--------------------------------	----

### MENU MODE

Remarks about Menu mode.....	23
Text settings.....	23
Recording settings .....	25

### FIXING PROBLEMS

Troubleshooting.....	26
----------------------	----

## Welcome !

Thank you for buying this Philips Compact Disc Recorder.

In the eighties Philips invented a new audio system - the CD. The CD (compact disc) revealed to you the new dimensions of digital sounds and added to the pleasures of audio.

Compact disc technology permits a high contrast in loud as well as in quiet passages, with perfect channel separation. Philips has now further developed compact disc technology and the result is the CD recorder.

With your Philips CD Recordable/ReWritable Recorder, you can record, play and erase your own high-quality audio CDs, subject to legal restrictions on copying. Naturally, you will also be able to play all pre-recorded audio CDs.

*Note: In the United Kingdom and certain commonwealth countries use of the Philips CD Recordable/Rewritable recorder as shown or suggested in this user manual may require the authorization of copyright holders.*

### About this manual

This manual gives instructions for operating this CD recorder where:

- the figures (1) throughout the text indicate a sequence of actions necessary to perform a certain operation;
- the arrows (→) indicate the reaction from the recorder;
- the dots (•) indicate remarks, advice or special options within a sequence of actions. The dot-marked instructions are not necessary for the required operation.

### Technical data

*Subject to modification without notice.*

#### General

Power consumption .....	15 W
Power consumption in Standby .....	6 W
Operating temperature .....	5-35° C
Weight.....	4 kg
Dimensions .....	435 x 310 x 88 mm

#### Audio

Frequency response .....	2Hz-22.050 Hz
Playback S/N (A-weighted) .....	115 dB
Playback S/N .....	110 dB
Playback dynamic range CDR.....	96 dB
Playback total harmonic distortion CDR.....	95 dB = 0.0017 %
Channel separation .....	115 dB
Recording S/N (A-weighted) .....	105 dB
Recording S/N digital without SRC .....	equal to source
Recording dynamic range.....	95 dB
Recording total harmonic distortion + noise .....	95 dB (0.0017%)

## Discs for recording

For recording use, special audio discs must be used (for music only). These Discs bear the logos as shown below. The text 'DIGITAL AUDIO' is present!

Your recorder uses two types of discs for recording purposes:

- **CD-Audio Recordable** (CDR) discs: fully recorded and finalized, these discs play on all CD players and recorders.



- **CD-Audio ReWritable** (CDRW) discs: can be recorded, erased and re-recorded hundreds of times. When finalized, they play on CDRW compatible CD players and recorders. In the course of 1999 most Philips CD players and recorders will be CDRW compatible.



To ensure proper working of the set we recommend the use of Philips audio CDR and audio CDRW discs only.

## Discs for playback

Your CD recorder is able to play:

- All pre-recorded audio CDs.
- All Audio CDR and Audio CDRW.

*Note: CDR(W) discs recorded with a computer can only be used when they are correctly treated according the audio standard (IEC958: Consumer part). Single session only!*

## Maintenance

For recording it is very important to use dust and scratch free discs.

To clean a CD, wipe it in a straight line from the center toward the edge using a soft, lint-free cloth. A cleaning agent may damage the disc! Write only on the printed side of a CDR or CDRW, and only with a soft felt-tipped pen.

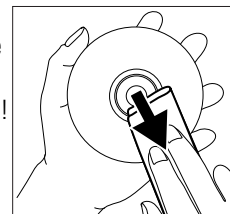

Clean the CD recorder with a soft, slightly dampened lint-free cloth. Do not use any cleaning agents as they may have a corrosive effect.

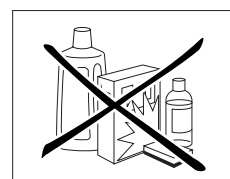

Do not expose the CD recorder, batteries or CDs to humidity, rain, sand or excessive heat (caused by heating equipment or direct sunlight).

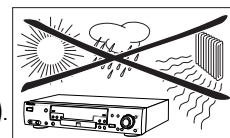

If the CD recorder cannot read CDs correctly use a commonly available cleaning CD to clean the lens before taking the CD player to be repaired. Other cleaning methods may destroy the lens. Always keep the tray closed to avoid dust on the lens.

The lenses may cloud over when the CD recorder is suddenly moved from cold to warm surroundings. It is not possible to play a CD then. Leave the CD recorder in a warm environment until the moisture evaporates.

## Accessories

- 2 Analog HQ audio cables (with red and white plugs)
- 1 Digital HQ coaxial cable (with black plugs)
- Power cord
- 2 Batteries
- Remote control
- Guarantee

# CONTROLS AND CONNECTIONS

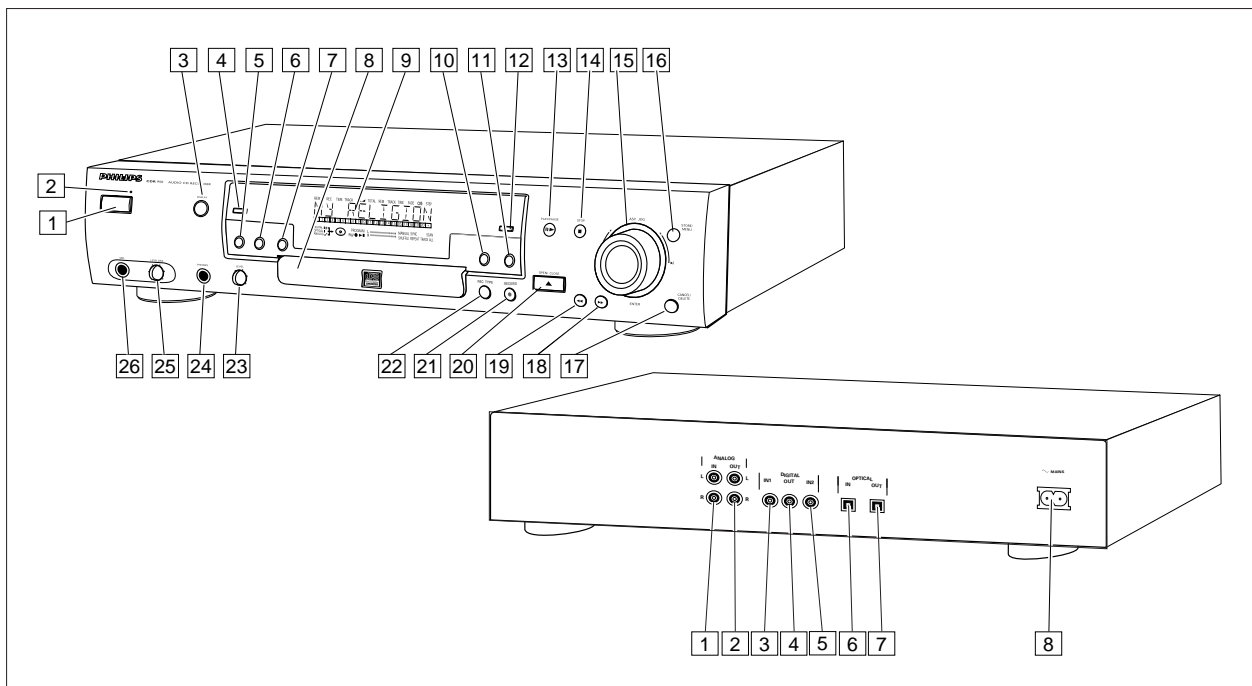

## Controls on the front

- 1 **ON/OFF** .....turns the CD recorder ON and OFF
- 2 Standby indicator
- 3 **DISPLAY** .....selects display information/text
- 4 **SCROLL** .....activates scrolling of text over the display (once)
- 5 **PROGRAM** .....opens/closes program memory
- 6 **REPEAT** .....repeats play (all, program or track)
- 7 **SHUFFLE** .....plays CD(RW) or program in random order
- 8 Disc tray
- 9 Display .....information screen
- 10 **ERASE** .....selects erasing mode
- 11 **FINALIZE** .....selects finalize mode
- 12 **SOURCE** .....selects input source
- 13 **PLAY/PAUSE** ► II .....starts play/interrupts play or recording
- 14 **STOP** ■ .....stops/clears a program
- 15 ◀ **EASY JOG** ▶ .....- previous/next track (Play and (rotate) Program mode)  
- recording level control (recording)  
- selects settings (menu on)
- ENTER** (push) .....- plays selected tracks  
- selects settings in Menu mode  
- programs track numbers
- 16 **STORE/MENU** .....- enters Menu mode  
- stores Menu settings
- 17 **CANCEL/DELETE** .....- deletes tracks from a program  
- deletes text in Menu mode  
- returns to a higher level in the menu
- 18 ►► .....- searches forward  
- cursor control in Menu/Prog. review mode

- 19 ◀◀ .....- searches backward  
- cursor control in Menu/Prog. review mode
- 20 **OPEN/CLOSE** ▲ .....opens/closes disc tray
- 21 **RECORD** .....starts recording, finalising, erasing
- 22 **REC(ord) TYPE** .....selects recording modes
- 23 **LEVEL** .....headphone volume control
- 24 **PHONES** .....socket for headphones
- 25 **LEVEL (MIC)** .....microphone/mix level controller
- 26 **MIC** .....socket for (stereo) microphone

*Note: Unless stated otherwise, all controls are on the front of the CD recorder. When provided on the remote control, you can also use the corresponding buttons, after selecting the CD recorder or separate CD player by pressing CDR or CD.*

## Connections at the back

- 1 **ANALOG IN** .....connects to the line output of an amplifier (left and right)
- 2 **ANALOG OUT** .....connects to the line input of an amplifier (left and right)
- 3 **DIGITAL IN 1** .....connects to the digital coaxial output of an external CD player
- 4 **DIGITAL OUT** .....connects to the digital coaxial input of e.g. amplifier or recording device
- 5 **DIGITAL IN 2** .....connects to the digital coaxial output of an extra CD player
- 6 **OPTICAL IN** .....connects to the digital optical output of an external CD player
- 7 **OPTICAL OUT** .....connects to the digital optical input of e.g. amplifier or recording device
- 8 Connection to mains

## DISPLAY indications

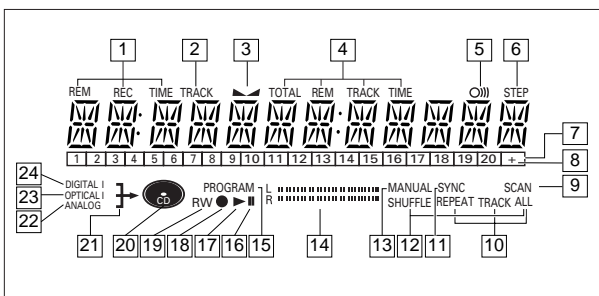

- 1 **REM/REC TIME** .....remaining recording time / recording time
- 2 **TRACK** .....track number
- 3 **▲** .....balance (lights during balance adjustment)
- 4 **TOTAL REM TRACK TIME** .....total or remaining time of disc or track
- 5 **FADE** .....fade active
- 6 **○))** .....remote control active
- 7 **STEP** .....indicates the number of tracks in a program
- 8 **Track bar** .....indicates:
  - tracks on a disc or in a program
  - track in play
- 9 **+ 20** .....disc or program contains more than 20 tracks
- 10 **SCAN** .....lights up when the first 10 seconds of each track are played
- 11 **REPEAT TRACK/ALL** .....lights up when a track/ complete disc (or program) is repeated
- 12 **SYNC** .....synchronized recording active
- 13 **SHUFFLE ALL** .....plays tracks in random order
- 14 **MANUAL** .....manual recording active
- 15 **L/R II** .....Record/play level bar, indicates the audio signal level
- 16 **PROGRAM** .....flashes during programming/ lights in program mode
- 17 **II** .....pause function active
- 18 **▶** .....lights during play
- 19 **●** .....lights during recording
- 20 **R(W)** .....unfinalized CDR(W) disc inserted
- 21 **CD** .....CD inserted (a pre-recorded CD or finalized CDR or CDRW disc)
- 22 **↶** .....lights during recording
- 23 **🎤** .....microphone connected
- 24 **ANALOG ↶** .....analog input selected
- 25 **OPTICAL I →** .....optical input I selected for external recording
- 26 **DIGITAL I ↶** .....digital input I selected for external recording
- DIGITAL II ↶** .....digital input II selected for external recording

## DISPLAY messages

Messages, as listed and explained here, may appear on the display for your guidance.

### General

- READING** .....reading disc information
- OPEN** .....during tray opening
- CLOSE** .....during tray closing
- NO DISC** .....no disc inserted, disc unreadable or disc inserted upside down
- PROG FULL** .....program full
- INSERT DISC** .....insert disc or insert disc in correct way
- WRONG DISC** .....inserted disc is no audio CD
- UNFINALIZED** .....unfinalized CDR(W) disc
- MEMORY xxP/0** .....indicates the amount of text memory used for unfinalized discs

### Recording

- WAIT** .....- when STOP ■ is pressed during recording
- .....- when STOP ■ is pressed during recording the first 4 seconds of a track
- UPDATE** .....updating disc contents
- DISC FULL** .....no more recording possible
- DIGITAL 1** .....digital coaxial input 1 selected
- DIGITAL 2** .....digital coaxial input 2 selected
- OPTICAL** .....digital optical input selected
- ANALOG** .....analog input selected
- MICROPHONE** .....microphone input selected
- COPY PROTECT** .....no digital recording can be made of the connected source
- NOTFINALIZED** .....when opening the tray with an unfinalized disc inserted
- MAKE CD** .....start of synchronized recording of a complete disc and Auto Finalize function selected
- RECORD DISC** .....start of synchronized recording of a complete disc
- RECORD TRACK** .....start of synchronized recording of a single track
- REC MANUAL** .....manual start of recording selected
- xx dB** .....level is being adjusted
- ERASE TRACK** .....when erasing one or more tracks
- ERASE DISC** .....when erasing a disc
- FINALIZE** .....when finalising a disc
- FINALIZED** .....when trying to finalize an already finalized disc
- CHECK INPUT** .....when RECORD is pressed while no digital source is detected
- xx xx ERASE** .....time countdown when erasing a track or a disc
- xx xx FINAL** .....time countdown when finalising a disc
- MONITOR MODE** .....sample rate convertor active
- PRESS RECORD** .....to start manual recording, finalising or erasing



# DISPLAY

- START SOURCE* .....to start synchronised recording from a source
- FINALIZED CD* .....when trying to record on a finalized CDR or a prerecorded CD
- UNFINALIZE/* .....when trying to record on a finalized CDRW
- PRESS ENTER* .....when a professional source is connected

## Play

- PROGRAM* .....program mode selected
- ALBUM TITLE* .....will be followed by album title
- TRACK TITLE* .....will be followed by track title
- ALBUM ARTIST* .....will be followed by artist name
- TRACK ARTIST* .....will be followed by track artist name

## Others

- NO AUDIO TR* .....when the recorder enters a data track during recording
- FINALIZE CD* .....laser power calibration performed 96 times, finalize disc
- INITIALIZING* .....during laser power calibration for unfinalized discs
- DISC RECOVER* .....during disc recovering after power failure
- OPC ERROR* .....OPC failure during OPC procedure (OPC = Optimum Power Calibration)
- RECORD ERROR* .....recording error in menu mode
- DISC ERROR* .....when trying to record on or finalize a recovered disc
- MEMORY FULL/* .....when text memory is full. To add a *FINALIZE CD* CD to the list, first finalize or erase another disc from the list.

## MENU messages - See Menu mode

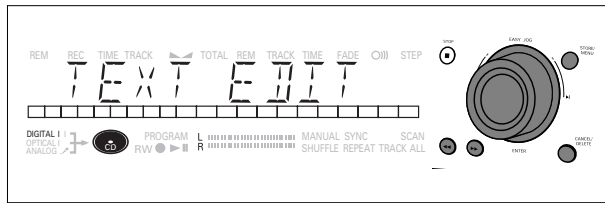

## Menu messages

- NO TRACKS* .....when attempting to edit text for a disc which has no tracks
- TEXT EDIT* .....when entering Text Edit mode
- CD ARTIST* .....when editing or erasing an artist name
- CD TITLE* .....when editing or erasing a title
- TR N ARTIST* .....when editing or erasing an artist name per track
- TR N TITLE* .....when editing or erasing a title per track
- TEXT ERASE* .....when entering Text Erase mode
- ALL TEXT* .....when entering All Text mode
- ERASE OK* .....when confirmation for erasing has to be given with ENTER key
- ERASE ALL OK* .....when confirmation for erasing has to be given with ENTER key
- ERASE MEMORY* .....when waiting for confirmation when erasing a disc
- MEMORY VIEW* .....when selecting text review per unfinalized disc in memory
- MEMORY EMPTY* .....when REVIEW is selected while no text is in memory
- AUTO TRACK* .....when selecting auto track increment ON or OFF
- ON* .....Auto Track increment or FADE on
- OFF* .....Auto Track increment or FADE off
- SET BALANCE* .....when selecting BALANCE
- SET FADE* .....when selecting FADE adjustment
- FADE ON OFF* .....when switching FADE on or off
- SET FADE IN* .....when setting the FADE IN time
- SET FADE OUT* .....when setting the FADE OUT time
- NO TEXT* .....no text stored for disc
- NAME SOURCE* .....when renaming input sources

## Connections general

For recording the following inputs are present:

- Digital optical input.
- Digital coaxial input 1.
- Digital coaxial input 2.
- Analog input.

For playback the following outputs are present:

- Digital coaxial output.
- Digital optical output.
- Analog output.

We advise you to connect these to the CD input on your amplifier.

The connections you make will depend upon the possibilities your audio equipment offers. Please refer to the user manuals for your other audio equipment first.

Digital recordings (optical or coaxial) give the best performance in audio and usability (e.g. auto-track). (The digital optical connection is less sensitive to external disturbances).

If your equipment does not offer digital connections, the high quality Analog-Digital-Converter of your CD recorder will ensure very good audio performance when recordings are made from the analog input.

Playback via the digital coaxial output of the CD recorder gives the best audio performance.

If your equipment does not offer digital connections, the high quality Digital-Analog-Converter of the CD recorder ensures a very good sound quality via the analog output.

We advise you to always establish both digital and analog connections. In this way you can always make analog recordings when digital recording is not possible.

We have described the most common ways of connecting the CD recorder. If you still have difficulties with the connections you can always contact the Philips Consumer Service desk in your country.

## Analog connections

Analog connection is required for playback of CDs (use cable ②) and for recording from external analog sources (use cable ①).

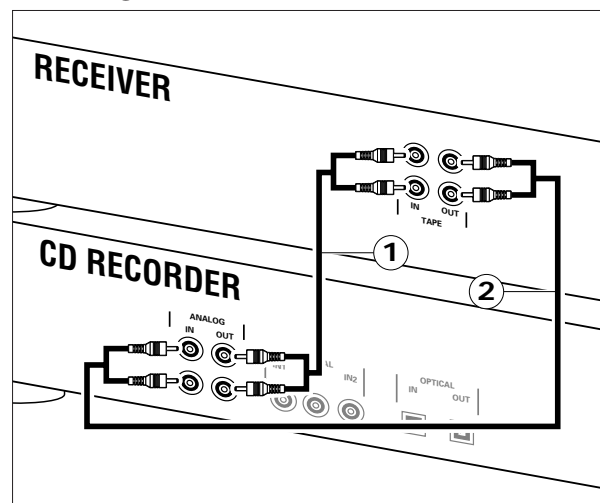

Use the audio cables supplied. Connect the red plugs to the R sockets, and the white plugs to the L sockets.

- 1 For recording, connect cable ① between the ANALOG IN-sockets on the CD recorder and the CDR LINE- or TAPE OUT-sockets of an amplifier.

*Note: For recording directly from a CD player, the ANALOG IN sockets of the CD recorder should be connected to the analog output of the CD player.*

- 2 For playback, connect cable ② between the ANALOG OUT-sockets on the CD recorder and the input sockets of an amplifier e.g. TAPE IN, CDR or AUX.

*Note: Never use the PHONO input.*

# INSTALLATION

## Digital coaxial connections

Digital coaxial connection is only required in case you wish to record from a CD player with a digital coaxial output.

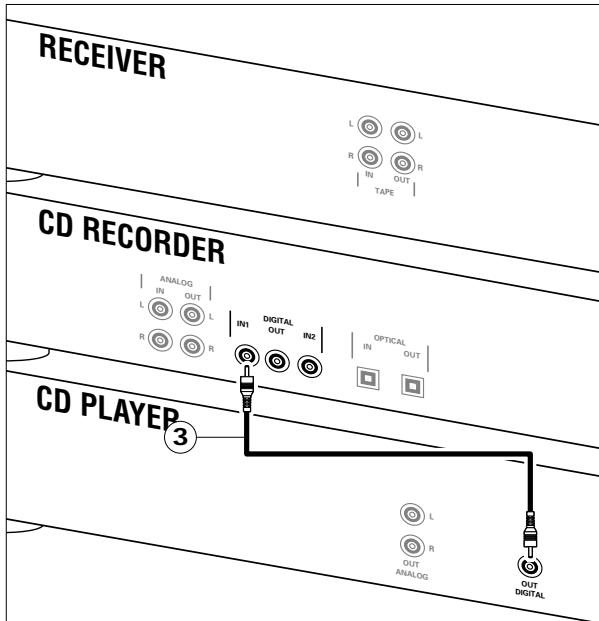

Use the digital coaxial cable supplied.

**1** For recording, connect the cable ③ between the DIGITAL IN-1 socket on the CD recorder and the DIGITAL OUT-socket of a CD player.

- If required you can connect an extra digital device (e.g. a DAT or DCC recorder) to the DIGITAL IN 2 socket of the recorder.

*Note: Your CD recorder is equipped with a digital coaxial output (DIGITAL OUT). This output can be used for digital playback.*

## Digital optical connections

Digital optical connection is only required in case you wish to record from a CD player with a digital optical output.

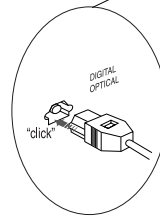
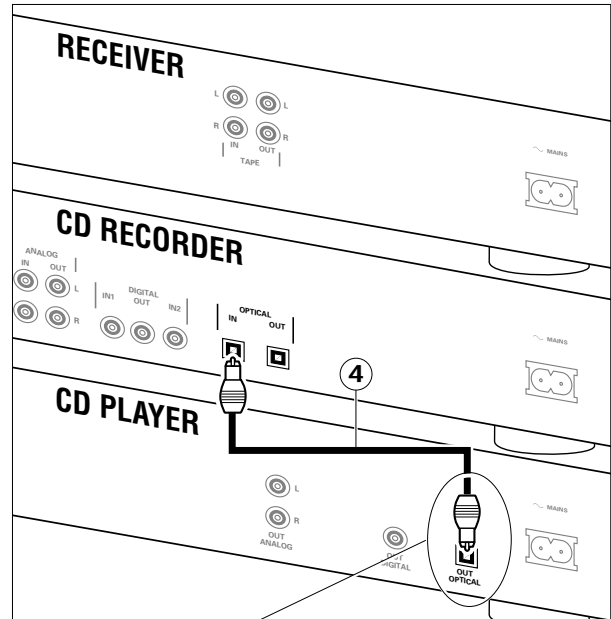

When connecting the Digital Optical cable, make sure it is fully inserted until there is a click.

**1** Remove the dust caps from the digital optical connection. (We recommend you save the cap).

**2** For recording, connect a fibre-optic cable ④ between the digital OPTICAL IN socket of the CD recorder and the digital-optical output of a CD player.

*Note: Your CD recorder is equipped with a digital OPTICAL output. This output can be used for digital playback.*

## Power supply

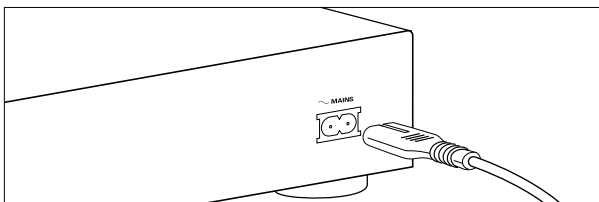

- 1 Plug the power cord supplied into the MAINS connector on the CD recorder, then into a mains socket.
- 2 Press ON/OFF.  
→ The recorder is now in Standby mode.
- 3 Press any key to activate the recorder.

*Note:*

- The CD recorder will automatically adjust to the local mains voltage.
- When the CD recorder is in the Standby mode, it is still consuming some power. If you wish to disconnect your recorder completely from the mains, press ON/OFF on the recorder front.

## Setup recommendations

- Place the CD recorder on a solid, vibration free surface.
- Do not place the CD recorder near a source of heat or in direct sunlight.
- Do not use the CD recorder under extremely damp conditions.
- If the CD recorder is placed in a cabinet, make sure that a 2.5 cm space remains free on all sides of the CD recorder/player for proper ventilation.

## Inserting batteries in the remote control

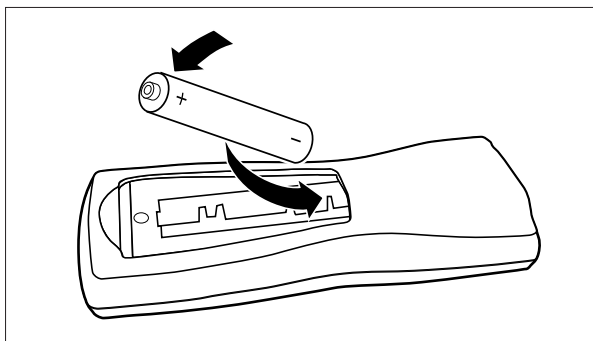

- 1 Open the battery compartment cover.
- 2 Insert 2 batteries ("AA", LR-6 or UM-3; as supplied) as shown.
- 3 Replace the cover.

*Note: We recommend you use 2 batteries of the same type and condition.*

**Batteries contain chemical substances, so they should be disposed of properly.**

# REMOTE CONTROL

## Remote control commands

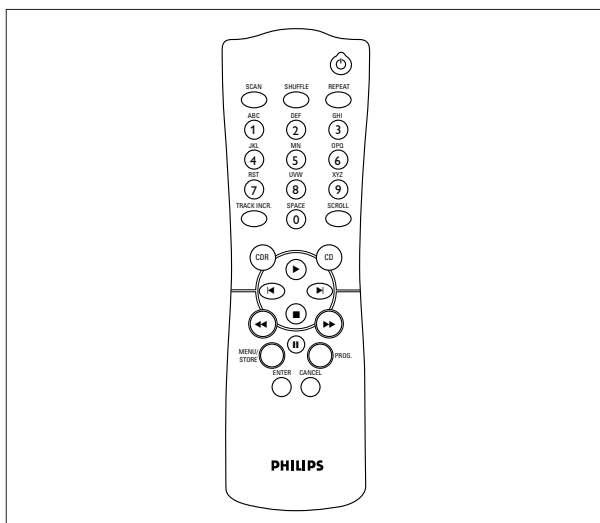

- STANDBY** .....switches to Standby/On/Off
- SCAN** .....plays the first 10 seconds of each track
- SHUFFLE** .....plays CD(RW) or program in random order
- REPEAT** .....repeat play
- Number/alphabet keys 0 - 9**
  - .....- selects a track by number
  - .....- selects character for text input
- TRACK INCR(ement)** .....increases track numbers during recording
- SCROLL** .....activates scrolling of text over the display
- CDR** .....selects CD recorder
- CD** .....selects CD player, can be used to control a separate Philips CD player
- ▶** .....starts CD(RW) play
- ◀** .....previous track (Play and Program mode)
- ▶|** .....next track (Play and Program mode)
- .....stops CD(RW) and clears a program
- ◀◀** .....- searches backward  
- cursor control in Menu/Prog. review mode
- ▶▶** .....- searches forward  
- cursor control in Menu/Prog. review mode
- ||** .....interrupts CD(RW) play/recording
- MENU/STORE** .....- enters Menu mode  
- stores Menu settings
- PROG.(ram)** .....opens/closes program memory
- ENTER** .....- selects settings in Menu mode  
- programs track numbers  
- starts playback of selected track
- CANCEL** .....- deletes tracks from a program  
- deletes text in Menu mode  
- returns to a higher level in the menu

## Inserting discs

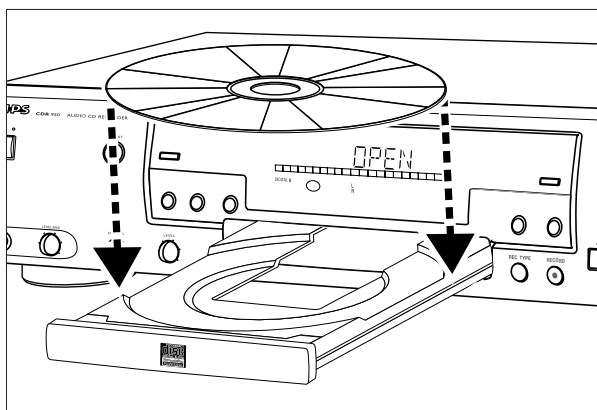

- 1** Press OPEN/CLOSE to open the disc tray.  
→ OPEN lights up.
- 2** Insert a CD, CDR or CDRW in the appropriate recess in the tray, label side up.
- 3** Press OPEN/CLOSE to close the tray (see also Playing a CD).  
→ CLOSE lights up, followed by READING and the display will show the type of disc you inserted.

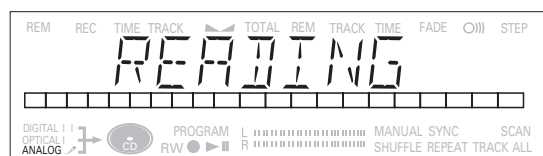

- If a CDR(W) is finalized it will show **CD** on the display.
- If CD-text is available the TITLE/ARTIST will scroll by.

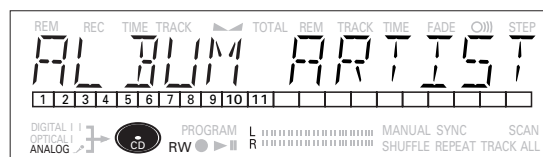

- Note:**
- Only Audio CDs will be accepted. If a non-audio disc is inserted, the display shows *WRONG DISC*.
  - For recording it is important that the blank disc is completely free from dust particles or scratches. (see Disc maintenance).
  - If you insert a blank or partly-recorded CDR or unfinalized CDRW, the CD recorder will calibrate the disc for optimum recording. During this process the display will first show *INITIALIZING* and then the number of audio tracks. Calibration can take up to 25 seconds.

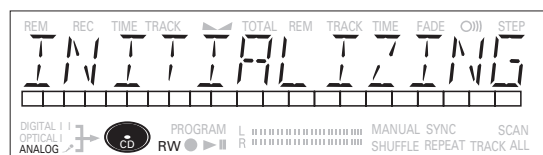

## Remarks about recording

You will soon discover how easy it is to make your own CDs. Nevertheless, it is advisable to use a CDRW disc for your first try.

- If the disc is a CDRW and is already finalized you must unfinalize it first.
- The recording procedure is the same for CDRs and CDRWs.
- If the disc already contains recordings, the CD recorder will automatically search for the end of the last track, so that recording can start from there.
- There must be at least 7 seconds of recording time left on the disc, otherwise you will not be able to enter record standby mode. *DISC FULL* then lights up.
- If the display indicates *COPY PROTECT*, no digital recording can be made of the source material. Recording will not start.
- The **Serial Copy Management System (SCMS)** only allows digital recording under specific conditions:
  - This means that it is not possible to make a digital copy from a digital copy.
  - Analog recording is always possible !
  - The number of recordings from the original is unlimited.
- A maximum of 99 tracks can be recorded on a disc. Minimum allowable track length is 4 seconds.
- Recordings from DAT or DCC players will not always stop automatically.

### Important:

**If you want to play the recorded CDR disc on any regular CD player, it must first be finalized. See finalising discs.**

**Finalized CDRW discs play only on CDRW compatible CD players.**

**For recording from CD changers do not use *REC MANUAL*.**

## Recording modes

Your recorder offers several recording modes.

- *RECORD DISC* - to make a synchronized recording of the complete disc or a program simply by starting the source.
- *RECORD TRACK* - to make a synchronized recording of a single track simply by starting the source.
- *REC(ord) MANUAL* - to manually start a recording simply by pressing the RECORD key.
- *MAKE CD* - to make a synchronized recording of the complete disc or a program simply by starting the source. Finalising will be done automatically.



### Some remarks on recording:

- When Auto track is ON (default setting), track numbers will automatically be increased during recording.
- By programming the source first, a compilation can be recorded.
- If a finalized CD recordable disc is inserted in the CD recorder, *FINALIZED CD* will be displayed when REC TYPE is pressed. Recording is not possible.
- If a finalized CD rewritable disc is inserted in the CD recorder, *UNFINALIZE* and *PRESS ENTER* will be displayed when the REC TYPE is pressed. If ENTER is pressed, the disc will be unfinalized.

# RECORDING

## Autostart recording

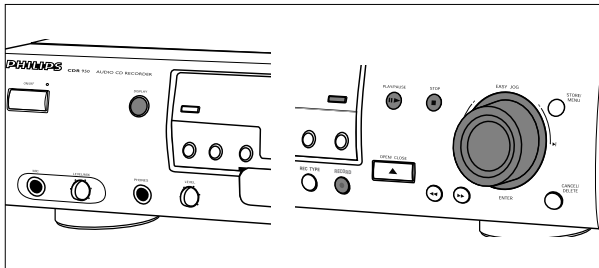

This feature enables you to make fast and easy recordings of a CD. Track increments are automatically detected from the source material. Track increments cannot be added manually. In analog source material a silence of 2.7 seconds or more is automatically detected as a track increment.

**Important:**

- Recording from CD-changers should always be started in the RECORD DISC, RECORD TRACK or MAKE CD mode.

### Preparing for autostart recording

- 1 Make sure the disc is absolutely free of scratches and dust particles.
- 2 Press SOURCE repeatedly until (depending on the connection used):  
 → DIGITAL I , DIGITAL II , OPTICAL I → or ANALOG lights up and DIGITAL 1, DIGITAL 2, OPTICAL or ANALOG appears on the display.

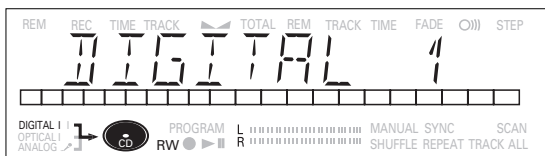

- 3 With the CD recorder stopped, press REC TYPE  
*once*: to select 'RECORD DISC';  
*twice*: to select 'RECORD TRACK';  
*four times*: to select 'MAKE CD'.  
 → and SYNC start to flash and the display shows the selection.

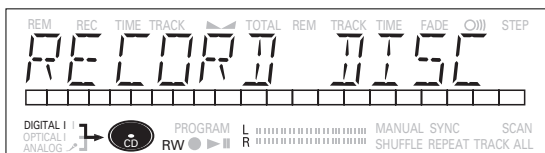

- If CHECK INPUT message also flashes, the digital connection is incorrect.

## Start autostart recording

- 1 To start recording, press PLAY on the selected source.  
 → The CD recorder automatically starts to record and lights continuously.
  - If, however, you start the source during a track, recording starts at the beginning of the next track or after 2.7 seconds of silence in analog recordings.
  - To check the elapsed recording time, press DISPLAY. (This can also be done during recording)
  - The recorder stops automatically.
- 2 To stop recording manually, press STOP on the CD recorder.  
 → WAIT lights up and SYNC and go out.
  - If STOP was pressed within 3 seconds after pressing PLAY, no recording will take place.
  - To interrupt recording, press PAUSE on the CD recorder.  
 → starts to flash. To resume, press RECORD on the CD recorder.

After recording the display will show UPDATE for several seconds.

Note: Recordings from DAT, DCC or analog sources will only stop after 20 seconds silence.

**Important:**

If you want to play the recorded CDR disc on any regular CD player, it must first be finalized. See finalising discs.

Finalized CDRW discs play only on CDRW compatible CD players.



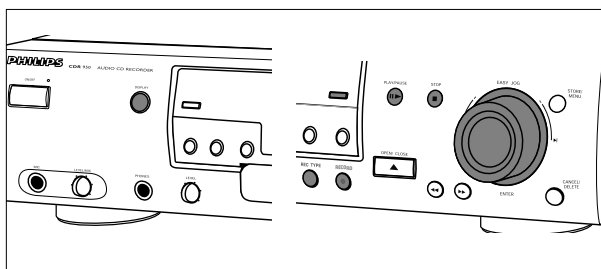

## Manual recording



### Important:

- Recording from CD-changers should always be started in the RECORD DISC, RECORD TRACK or MAKE CD mode.
- Only make analog recordings when digital recording is not possible.

### Preparing for manual recording

- 1 Make sure the disc is absolutely free of scratches and dust particles.
- 2 Press SOURCE repeatedly until (depending on the connection used):
  - DIGITAL I , DIGITAL II , OPTICAL I  or ANALOG  lights up and DIGITAL 1, DIGITAL 2, OPTICAL or ANALOG appears on the display.

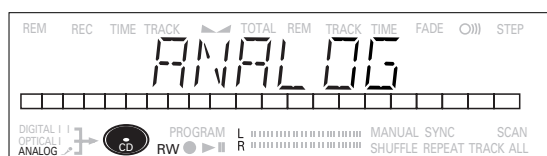

- When Auto Track is ON (default setting), track numbers will automatically be increased during recording.
- To switch off the Auto Track function you have to enter Menu mode. If you wish to increase track numbers manually, press TRACK INCR(ement) on the remote control. For further instructions see Menu mode.

ON (AUTO): The track increments are automatically taken over from the digital source material or after 2.7 seconds silence during analog recording.

OFF (MANUAL): Track numbers can be incremented manually by pressing TRACK INCR(ement) on the remote control. (Minimum track length is 4 sec.) (This can also be done in Auto mode.)

- Track numbers cannot be changed after recording.

Note: Auto track works only with Consumer Sources with a digital output signal according to the IEC 958 (consumer part) audio standard.

- 3 With the recorder stopped, press REC TYPE three times to enter the Manual Record standby mode.

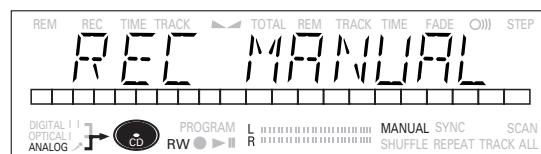

→ MANUAL starts to flash and the display shows REC MANUAL.



- If CHECK INPUT message also flashes, the digital connection is incorrect.
- 4 Play the source first to set the optimal recording level on the CD recorder.
  - 5 Rotate the EASY JOG/ENTER key until, on the Record/Play Level bar, all the blue segments are alight, but the red segments do not light continuously during the loudest passages.
    - Display shows -XX dB.
  - 6 Stop the source.

### Start manual recording

- 1 To start recording, press RECORD on the CD recorder and immediately start the source (from stop-mode).
  -  lights continuously. The track number and recording time appear on the display.

- To record a 3-second silence at the start of a track, press PAUSE on the CD recorder before starting the source.
  - To check the elapsed recording time, press DISPLAY on the CD recorder. (This can also be done during the recording.)
- 2 To stop recording, press STOP on the CD recorder.
    - WAIT lights up and  goes out.
  - If STOP was pressed within 3 seconds after RECORD, no recording will take place.
  - To interrupt recording, press PAUSE on the CD recorder.
    -  starts to flash. Resume at step 1.

After recording the display will show UPDATE for several seconds.

Note: With AUTO TRACK ON, the recorder will stop and go to REC STANDBY for 1 minute and then goes to stop mode automatically. Recordings from DAT, DCC or recordings made analogously will stop after 20 seconds silence. With AUTO TRACK OFF, the auto stop mode is disabled.



# RECORDING

## **Important:**





**If you want to play the recorded CDR disc on any regular CD player, it must first be finalized. See finalizing discs.**

**Finalized CDRW discs play only on CDRW compatible CD players.**

- Use the LEVEL (MIC) key to mix your voice with the sound from the source.
- Use the EASY JOG key to set the recording level.
- For details about recording see the instructions in the previous chapters.

## Microphone recording

### Karaoke recording

- 1 Connect a (stereo) microphone to the MIC socket.  
→  lights up. The previously active source will be selected automatically.
- You can now mix your voice with the sound from the selected source (DIGITAL I , DIGITAL II , OPTICAL I  or ANALOG .
- 2 Use the REC TYPE key to select the required recording mode: RECORD DISC, RECORD TRACK, REC MANUAL or MAKE CD.
  - 3 To start recording press PLAY on the selected source (RECORD DISC, RECORD TRACK or MAKE CD selected).
- Press RECORD on the recorder and PLAY on the selected source (REC MANUAL selected).
  - Use the LEVEL (MIC) key to mix your voice with the sound from the source.
  - Use the EASY JOG key to set the recording level.
  - For details about recording see the instructions in the previous chapters.

### Microphone recording

- 1 Connect a (stereo) microphone to the MIC socket.  
→  lights up. The previously active source will be selected automatically.
- 2 Press SOURCE repeatedly until MICROPHONE is displayed.



- 3 Use the REC TYPE key to select REC MANUAL.
- 4 Press RECORD to start recording.

## Sample rate convertor (Monitor mode)

The sample rate convertor is used to convert input signals into CD-standard digital output signals.

- 1 Connect the non digital source to one of the input sockets of the recorder.
  - 2 Connect the optional recording device to the DIGITAL OUT or OPTIONAL OUT output socket.
  - 3 Press REC TYPE (without a disc inserted in the recorder).  
→ MONITOR MODE is displayed. The signal will now be converted into a CD-standard digital output signal (44.1 kHz).
- Use the EASY JOG key to set the recording level.

## Finalizing CDR & CDRW discs

Finalizing is a simple procedure, necessary to:

- be able to play recordings on a CD PLAYER,
- avoid further unwanted recordings on a disc,
- avoid erasure of tracks on a CDRW.

### Auto finalizing

Auto finalizing is possible when using the MAKE CD recording function.

### Manual finalizing

1 Make sure the disc (in the CD recorder) is absolutely free of scratches and dust particles.

2 With the recorder stopped press FINALIZE.

→ The display shows **FINALIZE** and **PRESS RECORD**.

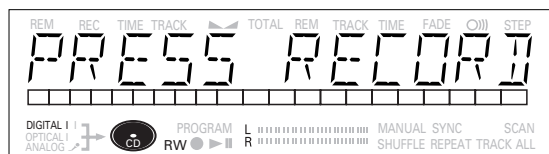
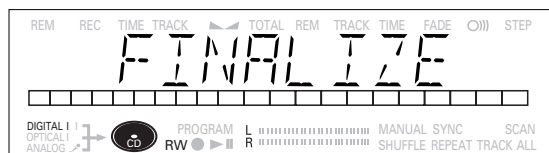

3 Press RECORD.

→ **xx xx FINAL** and the approximate finalisation time appears on the display.

The display counts down through the finalisation.

On completion, the total number of tracks and the total time recorded appears on the display.

For CDR(W), **CDR(w)** changes to **CD** on display.

Finalizing will take at least 2 - 4 minutes.

Note: During finalisation, the CD recorder accepts no operating commands.

## Unfinalizing CDRW discs

### For CDRW discs only.

If you want to make more recordings (or erasures of tracks) on a finalized disc you must unfinalize it first. The Table of Contents (TOC) will be removed.

To unfinalize:

1 With the CD recorder stopped, press REC TYPE or ERASE.

→ **UNFINALIZE** and **PRESS ENTER** will appear on the display.

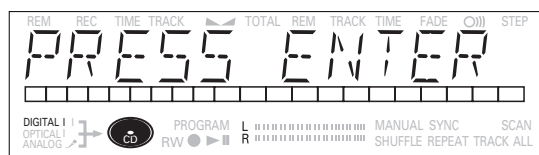
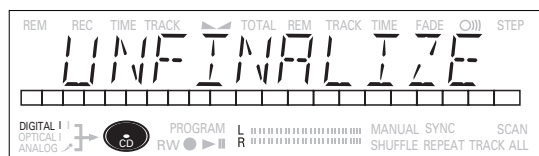

2 Press ENTER.

→ The disc will now be unfinalized and can be recorded on again.

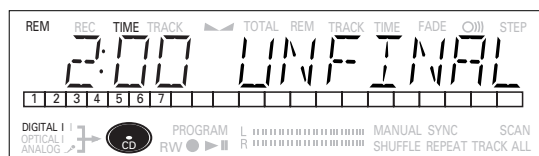

### Note:

- Unfinalizing will take approximately 2 minutes.
- When unfinalizing a CDRW disc with text on it available, this text will be transferred to the CD recorder memory. It may occur that the text memory is full. The message **MEMORY FULL/FINALIZE CD** will be displayed. You will now have to erase text, stored for other discs, or finalize another disc in order to obtain memory space.

# RECORDING

## Erasing CDRW discs

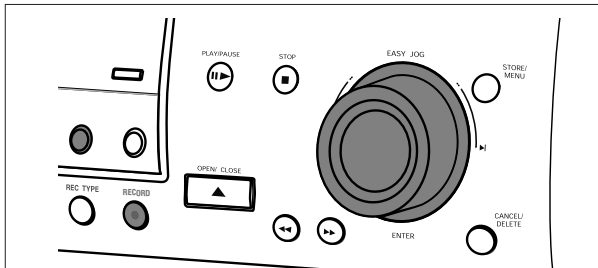

For unfinalized CDRW discs only.

You can erase:

- one or more tracks from the end,
- the entire disc.

### To erase one or more tracks from the end:

1 Press ERASE once.

→ The display shows the number of tracks and their total playing time. *ERASE TRACK* and *PRESS RECORD* lights up.

- If the disc is finalized, **CD** appears on the display after inserting a CDRW in the recorder. The recorder will ask you to confirm unfinalizing first. Confirm by pressing the EASY JOG/ENTER key or ENTER on the remote control.

2 Select the track(s) you wish to erase by turning the EASY JOG/ENTER key to the left and confirm by pressing this key.

→ The selected track numbers start blinking on the track bar.

→ The display shows the remaining number of tracks and the remaining playing time after erasing the selected track(s).

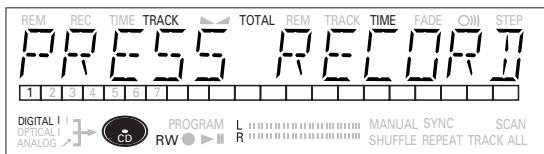
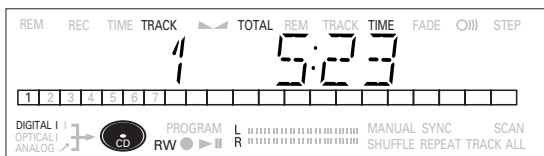

3 Press RECORD.

→ The display shows the total countdown time and *ERASE*.

→ After the selected track(s) have erased, the display shows the remaining tracks and their total playing time.

### To erase the entire disc:

1 Press ERASE twice.

→ The display shows the number of tracks and their total playing time. *ERASE DISC* and *PRESS RECORD* light up.

- If the disc is finalized, **CD** appears on the display after inserting a CDRW in the recorder. The recorder will ask you to confirm unfinalizing first. Confirm by pressing the EASY JOG/ENTER key or ENTER on the remote control.

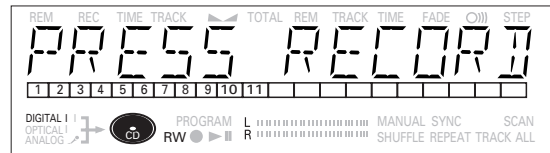
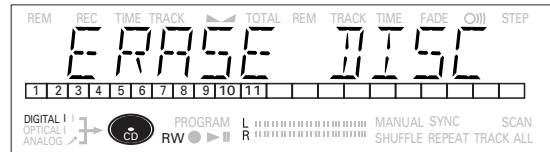

2 Press RECORD.

→ The display shows the total countdown time and *ERASE*. The complete disc will be erased.

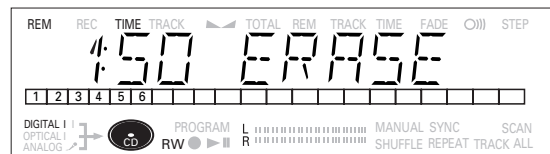

Erasure of a complete disc may take up to 1.5 minutes.

### Playing a CD

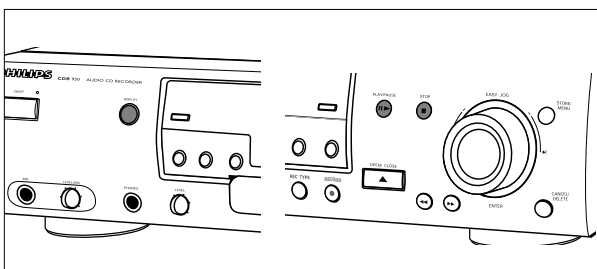

- 1 Press PLAY/PAUSE ►|| to start CD play.  
→ ► lights up and the track number and track time of the track in play appear on the display.
- 2 Press DISPLAY once, twice or three times:  
→ Remaining track time, total remaining time, text information (see Menu Mode).
- 3 To interrupt play temporarily, press PLAY/PAUSE ►|| again.  
→ || lights on the display
- 4 To continue play, press PLAY/PAUSE ►|| again.
- 5 To stop play, press STOP ■.  
→ The number of tracks and the total playing time appear on the display.

### Selecting a track

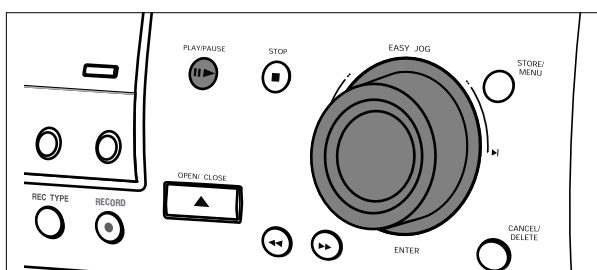

#### Selecting a track during play

- 1 Turn the EASY JOG/ENTER key until the required track number appears on the display.  
→ Play skips to the beginning of the selected track.
- or
- Key in the required track number using the numerical keys on the remote control. For 2-digit track numbers, press the keys in rapid succession.  
→ Play skips to the beginning of the selected track.
- or
- Press ◀ or ▶ on the remote control one or more times.  
→ Play skips to the beginning of the present, previous or subsequent tracks.

#### Selecting a track when CD play is stopped

- 1 Turn the EASY JOG/ENTER key until the required track number appears on the display.
  - 2 Press EASY JOG/ENTER or ENTER on the remote control to confirm or press PLAY/PAUSE ►|| to start playing.
- or
- 1 Key in the required track number using the numerical keys on the remote control. For 2-digit track numbers, press the keys in rapid succession. Play starts.
- or
- 1 Briefly press ◀ or ▶ one or more times.
  - 2 Start playback by pressing PLAY/PAUSE ►||, EASY JOG/ENTER or ENTER on the remote control.

### Search

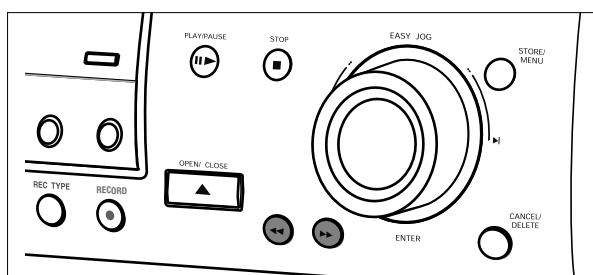

- 1 Hold down ◀◀ or ▶▶.  
→ The player first searches backwards or forwards at 10 times normal speed with sound at low volume, then goes to 50 times normal speed with sound muted.
- 2 Release the button at the desired passage.  
→ Play starts at the desired passage.

*Note: During Shuffle, Repeat Track or Programmed play, search is restricted to within the track being played at the time.*

### Shuffle (random order) play

- 1 Press SHUFFLE before or during CD play to start shuffle play.  
→ The tracks on the CD (or program if set) play in random order.
- 2 Press SHUFFLE again to return to normal CD play.

*Note: Shuffle is also cleared if you open the disc tray.*

**Repeat CD, track or program**

- 1 Press REPEAT one or more times during CD play.  
→ When **REPEAT TRACK** lights up, the current track plays repeatedly. When **REPEAT ALL** lights up, the disc or program plays repeatedly.

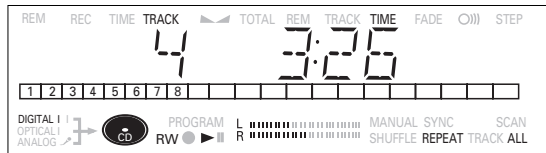

- 2 To return to normal play, press REPEAT one or more times until:  
→ The **REPEAT** label disappears from the display.

*Note:*

- You can use shuffle in combination with **REPEAT ALL** or programmed play.
- **REPEAT** is also cleared if you open the disc tray.

**Remarks about programming**

- You can program up to 99 tracks to play in any desired sequence.
- Tracks can be programmed more than once, but each time counts as a track (**STEP**).

**Programming**

- 1 In Stop mode press PROGRAM to enter Program mode.  
→ **PROGRAM** flashes and **PROGRAM** appears on the display.

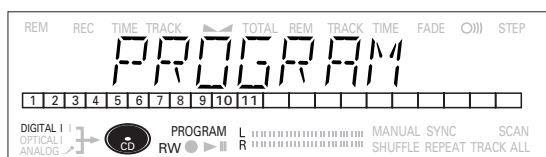

- 2 Select the required track numbers by turning the EASY JOG/ENTER key left or right and store by pressing ENTER.

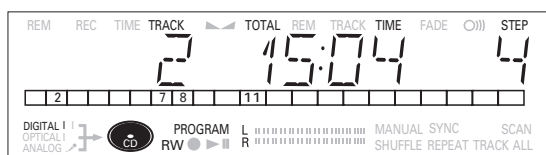

or:

- Key in a track number with the number keys. For 2-digit numbers, press the keys in rapid succession.
- The track will be stored in the program.
- The track number, total program time and the number of programmed tracks (**STEPS**) are displayed.

- 3 Repeat step 2 for all tracks to be programmed.
- 4 Press STOP or PROGRAM to end programming.  
→ **PROGRAM** lights continuously.
- 5 Press PLAY/PAUSE ►|| to start programmed play.

*Note:*

- To review the program, press PROGRAM, followed by ◀◀ or ▶▶ with the CD recorder in Stop mode.
- To add more tracks to the program, repeat steps 1 to 5.
- If you try to store more than 99 tracks, **PROG FULL** appears on the display.

**Clearing a program**

- 1 Press STOP ■ if necessary to stop programmed play.
  - 2 Press STOP ■ again to clear the program.  
→ **PROGRAM** disappears from the display.
- The program is also cleared if you open the disc tray.

**Erasing a track from a program**

- 1 In Stop mode press PROGRAM to enter Program mode.
- 2 Use ◀◀ or ▶▶ to select the track from which to delete.  
→ The track number and program step will be shown on the display.
- 3 Press CANCEL to erase the track from the program.  
→ The remaining program steps and the remaining playing time of the program will be displayed.



# MENU MODE

- 4 Press EASY JOG/ENTER or ENTER on the remote control to confirm.  
→ The display will ask you to reconfirm your selection.
- 5 Press EASY JOG/ENTER or ENTER on the remote control to reconfirm.
- 6 Press STORE/MENU to return to the submenu or STOP ■ to exit.

## Text Memory Review/Erase Text Memory

- 1 Select the MEMORY VIEW submenu.  
→ MEMORY VIEW appears on the display.
- 2 Press EASY JOG/ENTER or ENTER on the remote control to confirm.
- 3 Select the disc you wish to erase.

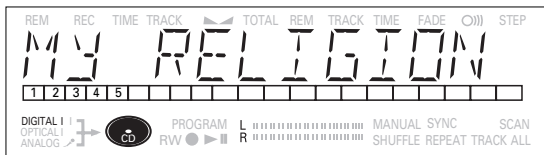

- 4 Press EASY JOG/ENTER or ENTER on the remote control to confirm.  
→ ERASE MEMORY appears on the display.

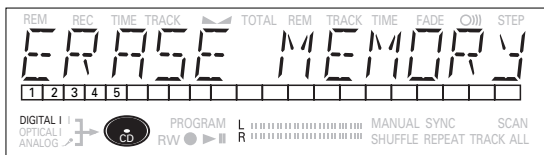

- 5 Press EASY JOG/ENTER or ENTER on the remote control to reconfirm.
- 6 Press the EASY JOG/ENTER key or ENTER on the remote control to confirm the erasure of the text for that particular disc.
- 7 Press STORE/MENU to return to the submenu or STOP ■ to exit.

### Note:

- If there are no discs in the memory, the message MEMORY EMPTY appears on the display.
- When the text memory of your CDRecorder is full, the message MEMORY FULL will appear, followed by FINALIZE CD. If you want to add a CD to the list of discs for which text is stored, you have to erase a disc from this list or finalize another disc. ("for which text is stored")
- MEMORY FULL/FINALIZE CD may also appear when unfinalizing a CDRW disc for which text was stored (see 'Unfinalizing CDRW discs'). The same action(s) should be taken in order to obtain memory space.

## Rename input source

- 1 Select the NAME SOURCE submenu.  
→ NAME SOURCE appears on the display.
- 2 Press EASY JOG/ENTER or ENTER on the remote control to confirm.
- 3 Select the input source you wish to (re)name.
- 4 Press EASY JOG/ENTER or ENTER on the remote control to confirm.
- 5 Select the characters by rotating the EASY JOG/ENTER key or by pressing the corresponding numeric/alphabet key on the remote control.
- 6 Press EASY JOG/ENTER or ENTER on the remote control to store the characters and move to the next cursor position.
- 7 Press STORE/MENU to store a name you have entered and move to the next item in the sub menu.

## Recording settings

### Auto track increment

- 1 Select the AUTO TRACKING sub menu.  
→ *AUTO TRACK* appears on the display.
- 2 Press EASY JOG/ENTER or ENTER on the remote control to confirm.
- 3 Select Auto track *ON* or *OFF*.

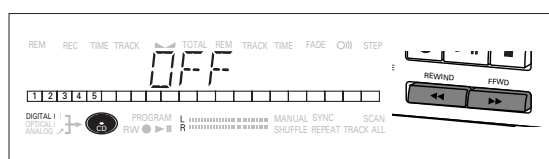

- 4 Press EASY JOG/ENTER or ENTER on the remote control to confirm.  
→ *ON* or *OFF* appears for 2 seconds on the display.
- When *ON* is selected, track numbers will be automatically incremented during recording.
  - When *OFF* is selected, you can number the recorded tracks yourself.
- 5 Press STORE/MENU to store settings and return to the submenu or STOP ■ to exit.

### Balance (Only active in Record/Standby mode)

- 1 Select the SET BALANCE submenu.  
→ *SET BALANCE* appears on the display.
- 2 Press EASY JOG/ENTER or ENTER on the remote control to confirm.  
→ and *L- 128 R- 128* appear on the display.

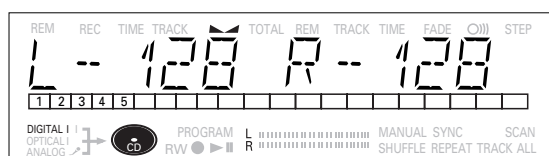

- 3 Adjust recording balance by turning the EASY JOG/ENTER key.
- Turn left: the figure left () counts up, right counts down.
  - Turn right: the figure right () counts up, left counts down.
- 4 Press EASY JOG/ENTER or ENTER on the remote control to confirm.
  - 5 Press STORE/MENU to store settings.

Note: The balance setting will not be stored.

### Fade

- 1 Select the SET FADE sub menu.  
→ *SET FADE* appears on the display.

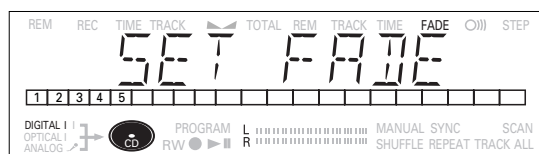

- 2 Press EASY JOG/ENTER or ENTER on the remote control to confirm.
  - 3 Select *FADE ON* or *OFF*.
  - 4 Press EASY JOG/ENTER or ENTER on the remote control to confirm.  
→ *ON* or *OFF* appears for 2 seconds on the display.
  - 5 Rotate EASY JOG/ENTER to select *SET FADE IN* or *SET FADE OUT*.
  - 6 Press EASY JOG/ENTER or ENTER on the remote control to confirm.  
→ *2000 MS* appears on the display.
  - 7 By turning the EASY JOG key you can set the FADE IN or FADE OUT time.
- FADE IN automatically starts when you press RECORD to start recording. Your recording will automatically be faded out when you press the STOP ■ or PLAY/PAUSE ► || key.
- 8 Press STORE/MENU to store settings and return to the submenu or STOP ■ to exit.



## TROUBLESHOOTING

If your CD recorder is defective, it is wise to check this list first. You may have forgotten a simple step.

### **Warning!**

***Under no circumstances should you attempt to repair the CD recorder yourself as this will invalidate the guarantee.***

**SYMPTOM** • possible solution:

- No power**
- ensure that the ON/OFF button is on: the CDRecorder is in standby mode, press any key to activate it
  - ensure that the mains cable is plugged in correctly
  - switch the recorder OFF and then immediately back ON

### **Auto track does not work**

- check if auto track is selected
- check if there are 2.7 seconds silence in between the tracks (analog recording only)
- check if the source is a consumer source with the digital output according to the IEC audio standard
- source is DVD player (no track information)

- No sound**
- check the audio connections
  - if using an amplifier, try using a different source

### **Amplifier sound is distorted**

- check that the CD recorder analog output is not connected to the amplifier Phono input

### **Play will not start**

- ensure that the label of the CD is facing up
- clean the disc
- check that the disc is not defective by trying another disc

### **Remote control does not work**

- point the remote control directly at the CD recorder
- check the batteries and replace if necessary
- select the right source first

### **Will not record**

- clean the disc
- check if CDR(W) is an unfinalized disc
- check that the disc is recordable and replace if necessary
- the disc is not an AUDIO disc (*WRONG DISC*)
- wrong input source chosen. Input label flashing (*CHECK INPUT*)
- text memory full (*MEMORY FULL / FINALIZE CD*). When a CDRW has to be unfinalized for recording. Erase text for other disc(s) or finalize other disc(s) to obtain memory space.

### **Recording is distorted**

- make sure the recording level is correct

### **20 second pause between recordings**

- see Autostart recording

### **Player does not react**

- switch the ON/OFF button on the front of the player off and back on

### ***DISC RECOVER* on display**

- a power failure has occurred during recording, the CD recorder is attempting to repair the disc
- if *DISC ERROR* then appears on the display, the disc cannot be recorded further, and cannot be finalized. But it can still be played on the CD recorder or another CD recorder.
- on a CDRW disc, the track being recorded is lost, but further recording and finalisation can still be done

The products and services described herein are not necessarily available in all countries.  
The specifications and design of this product are subject of change without notice.

Printed in Belgium.

© PHILIPS 1999  
<http://www.philips.com>

All trademarks acknowledged.



3104 125 2293.1