

CD-Recordable/Rewritable

CDD3610

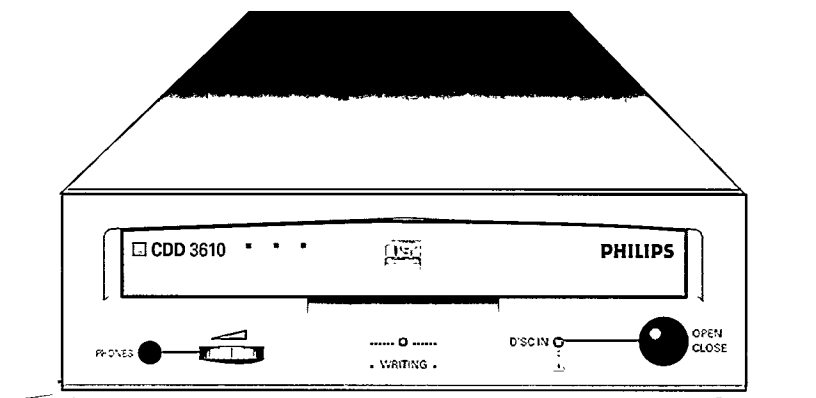

- Ⓒ User's manual
- Ⓓ Benutzerhandbuch
- Ⓕ Manuel d'utilisation
- Ⓘ Guida dell'Utente
- Ⓔ Guia del usuario
- Ⓓ Gebruikershandleiding



PHILIPS

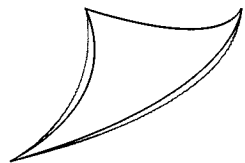

CDD3610 CD - Compact Disc Recordable/Rewritable

FIG.1

Front view

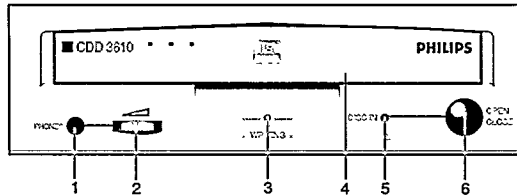

Rear view

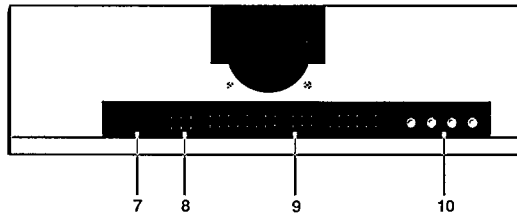

FRONT VIEW (GB)

1. Headphone plug
2. Headphone volume control
3. Write indicator
4. Disc Tray
5. Disc In/Active/Error indicator
6. Open/Close button

REAR VIEW

7. Audio Line Out connector
8. Jumperblock
9. IDE connector
10. Host DC power connector

VORDERANSICHT (D)

1. Anschlußbuchse Kopfhörer
2. Lautstärke Kopfhörer
3. Schreibanzeige
4. Schublade
5. Diskette ein/Activ/Fehler anzeige
6. Open/Close Taste

RÜCKANSICHT

7. Tonanschluß Aus-Connector
8. Jumperblock
9. IDE Connector
10. Host Gleichstromnetzanschluß

PANNEAU AVANT (F)

1. Prise pour casque
2. Commande du volume du casque
3. Témoin lumineux d'enregistrement
4. Tiroir à disque
5. Témoin disque/Activé/erreur
6. Touche ouvrir/fermer

PANNEAU ARRIERE

7. Connecteur de sortie de ligne audio
8. Cavaliers
9. Connecteur IDE
10. Connecteurs au bloc d'alimentation C.C. hôte

PARTE ANTERIORE (I)

1. Presa cuffie
2. Controllo volume cuffie
3. Indicatore di scrittura
4. Cassetto del disco
5. Indicatore disco inserito/Attivo/Errore
6. Tasto Apertura/Chiusura

PARTE POSTERIORE

7. Connettore Line Out Audio
8. Blocco Jumpers
9. Connettore IDE
10. Connettore alimentazione DC

VISTA FRONTAL (E)

1. Clavija de los auriculares
2. Control del volumen de los auriculares C.D.
3. Indicador escritura
4. Bandeja del Disco
5. Indicador de Disco introducido/Activo/Error
6. Bóton de Apertura/Cierre

VISTA POSTERIOR

7. Conector de salida de Línea de Audio
8. Bloque de conectores
9. Conector IDE
10. Conector de alimentación

VOORZIJD (NL)

1. Hoofdtelefoon aansluiting
2. Hoofdtelefoon volumeregelaar
3. Schrijfindicator
4. Disc-lade
5. Disc aanwezig/ Actief/foutindicator
6. Openen/sluiten-toets

ACHTERZIJD

7. Audio-connector lijnuitgang
8. Jumper-block
9. IDE connector
10. Voedingsconnector host computer

WARNING

This device complies with Part 15 of the FCC (U.S.A.) Rules. Operation is subject to the following two conditions: (1) This device may not cause harmful interference, and (2) this device must accept any interference received, including interference that may cause undesired operation.

NOTE

This equipment has been tested and found to comply with the limits for a Class B digital device, pursuant to Part 15 of the FCC Rules. These limits are designed to provide reasonable protection against harmful interference in a residential installation. This equipment generates, uses and can be used in accordance with the instructions, may cause harmful interference to radio communications. However, there is no guarantee that interference will not occur in a particular installation. If this equipment does cause harmful interference to radio or television reception, which can be determined by turning this equipment off and on, the user is encouraged to try to correct the interference by one or more of the following measures:

- Reorient or relocate the receiving antenna.
- Increase the separation between the equipment and receiver.
- Connect the equipment into an outlet on a circuit different from that to which the receiver is connected.
- Consult the dealer or an experienced radio/TV technician for help.

IMPORTANT

Any change or modifications to the equipment by the user not expressly approved by the grantee or manufacturer could void the user's authority to operate such equipment.

FOR EUROPE



"The CDD3610 is in conformity with the EMC directive and low-voltage directive."

ENGLISH (®)

INTRODUCTION	1
INSTALLATION	3
SUMMARY OF CONTROLS AND CONNECTIONS	9
OPERATING/TESTING YOUR CD-RECORDABLE/REWRITABLE SYSTEM	11
ADDITIONAL INFORMATION	13
APPENDIX	19

DEUTSCH (®)

EINLEITUNG	33
INSTALLATION	35
BEDIENELEMENTE UND ANSCHLÜSSE	41
BEDIENUNG UND PRÜFUNG DES CD-RECORDABLE/REWRITABLE-SYSTEMS	43
ZUSÄTZLICHE INFORMATIONEN	45
HINWEISE	46

FRANÇAIS (®)

INTRODUCTION	47
INSTALLATION	49
RÉSUMÉ DES COMMANDES ET CONNEXIONS	55
UTILISEZ/TESTEZ VOTRE SYSTÈME POUR CD ENREGISTRABLE/RÉENREGISTRABLES	57
INFORMATIONS COMPLÉMENTAIRES	59
REMARQUES	60

ITALIANO (®)

INTRODUZIONE	61
INSTALLATION	63
SOMMARIO DEI COMANDI E DEI COLLEGAMENTI	69
USO/VERIFICA DEL FUNZIONAMENTO DEL SISTEMA REGISTRATORE/REWRITABLE	71
ALTRE INFORMAZIONI	73
NOTAS	74

ESPAÑOL (®)

INTRODUCCION	75
INSTALACION	77
RESUMEN DE CONTROLES Y CONECTORES	83
FUNCIONAMIENTO/PRUEBA DEL SISTEMA DE CD-GRABABLE/REESCRIBIBLE	85
INFORMACION ADICIONAL	87
OBSERVACIONES	88

NEDERLANDS (®)

INLEIDING	89
INSTALLEREN	91
BEDIENINGSOVERZICHT EN AANSLUITINGEN	97
BEDIENEN/TESTEN VAN UW CD-RECORDABLE/REWRITABLE-DRIVE	99
EXTRA INFORMATIE	101
OPMERKINGEN	102

LASER SAFETY

This unit employs a laser. Do not remove the cover or attempt to service this device when connected due to the possibility of eye damage.

LASER-SICHERHEIT

In das Gerät ist ein Laser eingebaut. Nehmen Sie die Abdeckung nicht ab und versuchen Sie nicht, das Gerät zu reparieren, solange es angeschlossen ist. Es besteht die Gefahr einer Augenverletzung.

CAUTION

USE OF CONTROLS OR ADJUSTMENTS OR PERFORMANCE OF PROCEDURES OTHER THAN THOSE SPECIFIED HEREIN MAY RESULT IN HAZARDOUS LASER RADIATION EXPOSURE.

WARNUNG

DIE VORNAHME VON REGELUNGEN ODER EINSTELLUNGEN ODER DIE DURCHFÜHRUNG VON VERFAHREN, DIE NICHT IN DIESEM DOKUMENT (DIESER BESCHREIBUNG; IM NACHSTEHENDEN TEXT) ANGEGBEN SIND, KANN EINE GEFÄHRLICHE EINWIRKUNG VON LASERSTRAHLUNG ZUR FOLGE HABEN.

**CLASS 1
LASER PRODUCT**

**LUOKAN I
LASERLAITE**

**KLASS 1
LASERAPPARAT**

**KLASSE 1
LASER-PRODUKT**

CAUTION	INVISIBLE LASER RADIATION WHEN OPEN AVOID EXPOSURE TO BEAM
VARO!	AVATTAESSA OLET ALTIINA NÄKYMÄTTÖMÄLLE LASER SÄTTEILYLLE ÄLÄ KATSO SÄTEESSEN
WARNING	OSYNLIG LASERSTRÅLNING NÄR DENNA DEL ÄR ÖPPNAD BETRAKTA EJ STRÅLEN
ADVERSEL	USYNLIG LASERSTRÅLNING VED ÅBNING. UNGÅ UNSAETTELSE FOR STRÅLING
DANGER	INVISIBLE LASER RADIATION WHEN OPEN AVOID DIRECT EXPOSURE TO BEAM
VORSICHT	INSICHTBARE LASERSTRAHLUNG WENN ABDECKUNG GEÖFFNET NICHT DEM STRAHL AUSSETZEN

LASER

Type	Semiconductor laser GaAlAs
Wave length	775~795 nm (at 25° C)
Output Power	2,5 mW (Read) 35 mW (Write)
Beam divergence	60 degree.

INTRODUCTION

CDD3610 is a new generation Half Height 5.25" Built-in CD-Recordable/ReWritable drive with the popular (Enhanced) IDE interface.

The drive is in fact a multi-function device, since it can be used as:

- fast CD-ROM reader (up to 6.5x speed)
- 1x and 2x speed CD-Recorder, e.g. to record your own CD-ROM's or Audio-CD's
- 2x speed CD-ReWritable device to use as your personal storage medium, by using Incremental Packet Writing

The CDD3610 is the ideal tool for publishing large amounts of data in compact form on CD. The new Incremental Packet Writing function will make this drive attractive to the general desktop PC-user for personal data storage.

CD-Recordable discs can be recorded at single and double speed, and in all standard formats, e.g. CD-Audio, CD-ROM (XA), CD-i and Video-CD among others.

Since these discs are recorded in accordance with the Orange Book (part II) specification, these discs can be played back on all compatible CD-players.

CD-ReWritable is a new feature which allows re-use of previously written (special CD-ReWritable) discs, by rewriting portions or the complete disc in accordance with the Orange Book (part III) specification.

Features of the CDD3610 CD-Recordable/ReWritable drive:

- Multi-function device (CD-ROM reader, CD-Recorder and CD-ReWritable drive)
- Supports Incremental Packet Writing for data storage applications and "drag & drop" File System support through the CD-UDF standard (endorsed by Optical Storage Technology Association or OSTA)
- Supports standardised Multi Media Commandset (MMC) as standardised by the American National Standards Institute (ANSI)
- Plug & Play read compatibility under Windows 95 and Windows NT
- Interfaces directly to low cost standardised (Enhanced) IDE connector on PC motherboard

Unpacking

If the CDD3610 package shows evidence of rough handling or damage and the drive does not function properly on initial startup: return the drive and damaged package to your supplier and request a replacement.

Lift out the CDD3610 and remove the packing pieces.
Check that the package contains following items :

- User manual
- Mounting screws + jumpers

An IDE flatcable and audio cable can be obtained from your supplier.

INSTALLATION

Precautions

This CD-Recordable/Rewritable drive, like all electronic equipment, is static sensitive.

- Please take the proper precautions when handling the drive, for example by touching the PC - chassis before touching the drive.
- Avoid touching the IDE connector pins as well as the audio-connector pins and the jumper pins.
- Keep the drive in its conductive wrapping until you are ready to install the drive in your computer.

Safety Precautions

- Europe: This drive shall be installed only with an EN60950 (IEC950) approved Power supply.
- USA/Canada: This drive is for use only with IBM compatible UL listed Personal Computers or Macintosh UL listed workstations weighing less than 18 kg.

Copyright Statement

It is a criminal offence, under applicable copyright laws, to make unauthorised copies of copyright-protected material, including computer programs, films, broadcasts and sound recordings. This equipment should not be used for such purposes.

Installing the drive

- ① Turn off your computer, monitor and other peripherals.
To disconnect your configuration completely from the mains, the mains plug has to be disconnected.

NOTE: OPEN THE COVER FLAP OF THIS BOOKLET FOR LOCATING THE DRIVE-CONNECTORS AND THEIR ORIENTATION.

- ② Remove the cover from your computer.
Please consult the manuals that came with your computer for specific details.

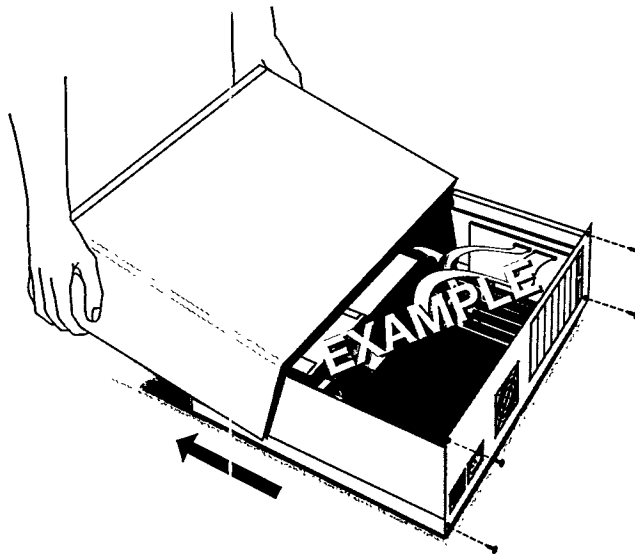

- ③ In order to mount the drive inside your PC (or other type of computer), locate a free horizontal 5.25" bay and follow the instructions, as provided with your computer systems, for installing the drive.

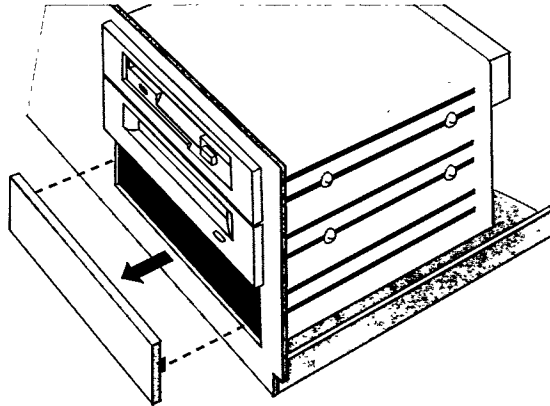

- ④ You have several possibilities to install your IDE data cable depending on your existing configuration:

- A) Hard-Disc connected as Master to Primary IDE Port,
 CD-ROM connected as Master to Secondary IDE Port:
 Connect CDD3610 as Slave to Secondary IDE Port.

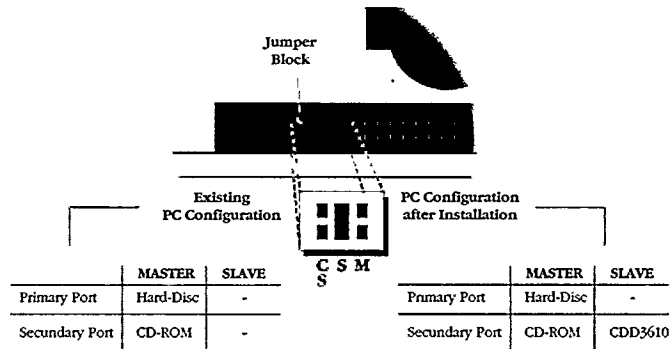

- B)** Single Hard-disc connected as master to Primary IDE Port:
Connect CDD3610 as Master to Secondary Port.

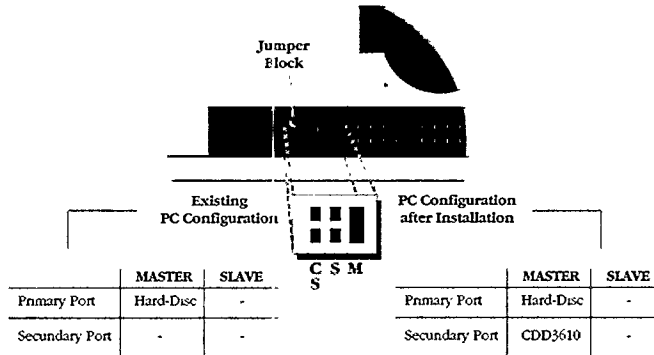

- C)** Hard-disc connected as Master to Primary IDE Port,
CD-ROM connected as Slave to Primary IDE Port:
Connect CDD3610 as Master to Secondary IDE Port.

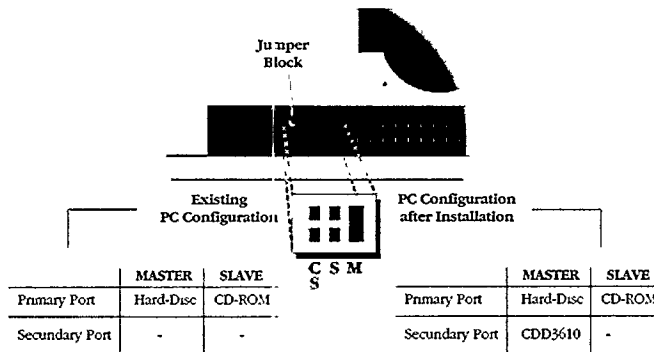

NOTE: INSTALLATION A IS PREFERRED FOR SYSTEMS WITH AN IDE HARD-DISC AND CD-ROM.

NOTE: INSTALLATION B IS PREFERRED FOR SYSTEMS WITH ONLY AN IDE HARD-DISC.

- ⑤ Locate the free end of the IDE data cable and thread it out through the open drive bay. Do the same with the power cable and the (optional) audio cable.

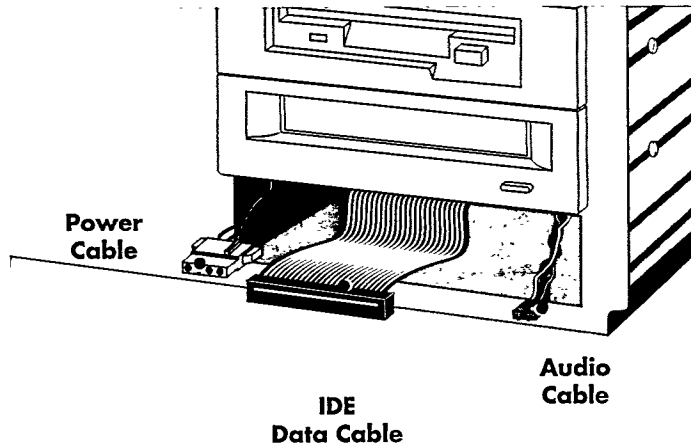

- ⑥ Connect your (optional) audio cable, IDE data cable and the power cable into the back of the CDD3610. Make sure you correctly align pin 1 of the cable to pin 1 of the connectors.

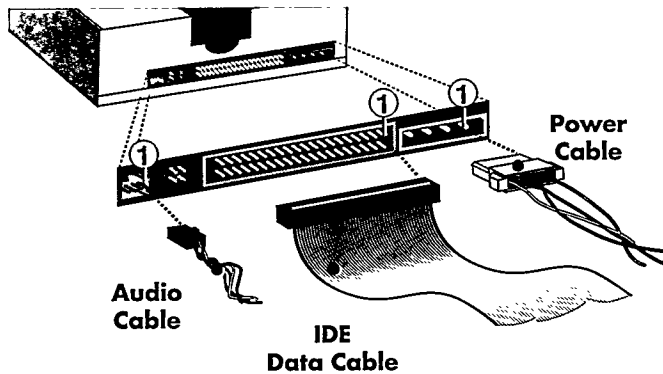

- ⑦ Insert the CDD3610 into the drive bay. Using all the screws included in the bag to secure the CDD3610 into the bay.

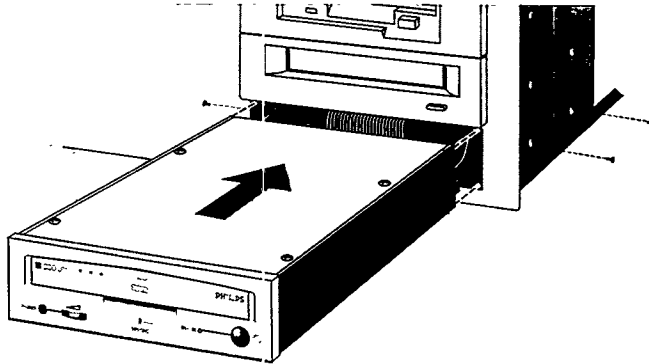

- ⑧ Replace the cover. Connect the mains plug of your configuration. When you have successfully installed the drive and established all connections, it is now time to switch on the PC. You are ready to run the selftest (See appendix) and then install the software.

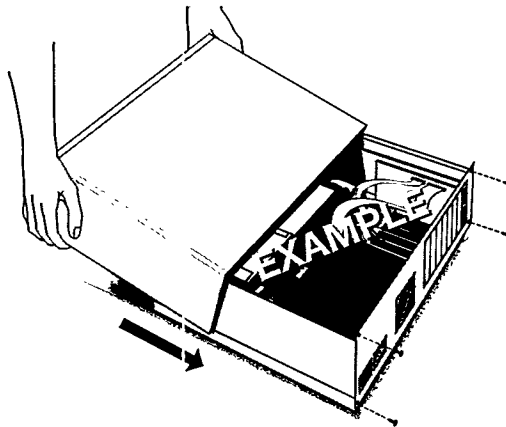

SUMMARY OF CONTROLS AND CONNECTIONS

Front view (See Cover Flap Fig.1)

1. HEADPHONE PLUG

Connect your headphone to listen to audio or music discs (or tracks).

2. HEADPHONE VOLUME CONTROL

Turn the wheel to the right to increase the audio volume of your headphone.

3. WRITE INDICATOR

Lights "orange" when writing of a disc occurs.
Flashes "orange" during write emulation.

4. DISC TRAY

5. DISC IN/ACTIVE/ERROR indicator (dual color LED)

Lights "green" when a disc is present. Flashes "green" asymmetrically when data is being read from disc or written to the disc. Flashes "green" symmetrically when starting up a disc. Lights "red" upon error (e.g. after failed selftest).

6. OPEN/CLOSE BUTTON

Press the OPEN/CLOSE button to open the disc loading tray. To close the disc loading tray, gently push the front of the tray or press the Open/Close button.

Rear view (See Cover Flap Fig.1)

7. AUDIO LINE OUT CONNECTOR

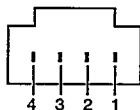

- | | |
|---------|----------|
| 1: Left | 2: GND |
| 3: GND | 4: Right |

8. JUMPERBLOCK

These jumpers are used to select Master/Slave mode and Cable Select (See Appendix for more information).

9. IDE CONNECTOR

40 pin IDE flatcable connector (See Appendix for more information).

10. HOST DC POWER CONNECTOR (type AMP 00641737-1)

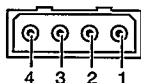

- | | |
|---------|--------|
| 1: +12V | 2: GND |
| 3: GND | 4: +5V |

OPERATING/TESTING YOUR CD-RECORDABLE/REWRITABLE SYSTEM

Loading and unloading a disc

- ① To open the tray: Press the Open/Close button.
- ② Load a disc, with the label facing upwards. The tray accommodates discs with 8 cm diameter (CD-Single) or the more usual 12 cm discs.

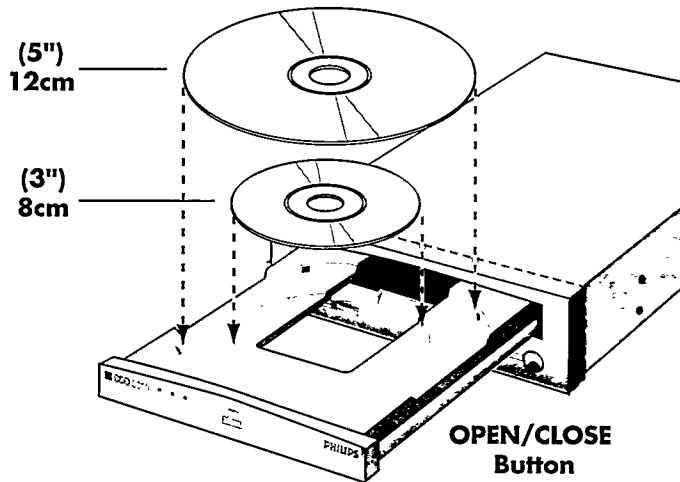

- ③ To close the tray, either push gently at the front of the tray or press the Open/Close button.

NOTE: FOR OPTIMAL RESULTS, USE PHILIPS CD-R OR CD-RW MEDIA.

NOTE: DON'T USE GENERAL PURPOSE COMMERCIAL HEAD CLEANING DISCS.

NOTE: DO NOT SWITCH OFF THE COMPUTER AND/OR THE DRIVE DURING THE RECORDING PROCESS, SINCE THIS MIGHT RESULT IN AN UNREADABLE D.S.C. PLEASE MAKE SURE THAT THE COMPUTER HAS FINISHED IT'S RECORDING PROCESS AND THAT THE WRITE INDICATOR ON THE FRONT OF THE DRIVE IS OFF.

Operating the CD-Recordable/Rewritable on the computer

Specific Application Software running on the computer platform in use, designed to work with the Philips CDD3610, must be used in order to be able to operate the CDD3610 correctly.

Software installation

The installation and operation of the necessary software is dependent off the computer configuration in which the CDD3610 is to be used, e.g. PC's, Windows 3.11, Windows 95, Windows NT, UNIX or other Operating Systems. Contact your supplier for the full list of supported host configurations and available software packages.

All trademarks acknowledged.

Command description

This drive supports commands based on the industry standard MMC (MultiMedia Command set). An extensive description of the total command set is available on request.

ADDITIONAL INFORMATION

Care of discs

- When loading a disc, allow time for the door to open and then gently insert the disc.
- Handle discs only by the outer and inner edges.
 - Never write with a ballpoint on the surface of the disc.
 - Do not store a disc in places with high temperature and humidity. Do not place the disc under direct sunlight.
- Store discs in their cases to prevent dust contamination, scratches, bending and other damages.
- When a disc becomes dirty, clean it with a cleaning cloth. Wipe the disc from the centre out. Do not use solvents such as benzene, thinner, commercially available cleaners, or anti-static fluids. Using fluids of these types may damage the disc.
- Empty discs are separately available through your dealer.

Technical data

PERFORMANCE

Capacity	
120mm disc	600 Mbytes/700 Mbytes
80mm disc	200 Mbytes
Access time average 1/3 data ⁽¹⁾	350 msec.
Access time max ⁽¹⁾	< 750 msec.
Data-transfer-rate (recording/reading)	352,8 Kbytes/sec sustained (double speed, mode 2 data) 176,3 (single speed, mode 2 data)
Data-transfer-rate (read only)	Up to 1145 Kbytes/sec (zoned-6 speed, mode 2 data) (see note)
Max. burst rate	≥ 2,5 Mbytes/sec
Interface	(Enhanced) IDE
Form factor	5,25" Half Height (drive should be mounted and used horizontally)
Data integrity from drive, assuming new discs	10 ⁻¹⁶
Data buffer	1Mb
Disc loading	Tray (motorised)

NOTE: When the drive is in zoned-6 read speed mode, this means that the momentary speed will increase linearly from 4 times speed at the inner diameter of the disc (ie. at beginning of Lead In) to the maximum of 6.5 times speed from 27 minutes disc time onwards.

(1) After spin up, including latency and command overhead, at 6 speed (only valid for reading).

DIMENSIONS Height: 41.5 mm (1.64 inch)
Width: 146 mm (5.75 inch)
Depth: 206 mm (8.11 inch)

WEIGHT less than 1 kg

POWER DISSIPATION max. 8W

Power Supply:

→ Voltage requirements: +12V (± 5%) +5V (± 5%)
→ Current requirements: +12V 160 mA typ.
200 mA max.
+5V 1 A typ.
1,5 A max.

ENVIRONMENTAL

Operating temp⁽¹⁾ 5 to 40° C (41 to 104 °F)
Non operating temp -25 to 70° C (-13 to 158 °F)

RELIABILITY

MTBF (hours 20% duty cycle)
120.000 POH

MEDIA

CD-R conform to "Orange Book"
part II
(CD-Recordable) and part III
(CD-ReWritable).

CERTIFICATION

FCC Compliance: Class B.
UL, CUL listed and CEBEC.
FDA-CDRH.

(1) Specifications for the "under pressure" case (incoming air flow through the front bezel) : A flow of at least 2 l/sec. of air at maximum 40°, must be realised. This will be achieved by realising at least -180 Pascal of pressure difference between inside the apparatus and outside.

Specifications for the "over pressure" case (outgoing air flow through the front bezel) : A flow of at least 2 l/sec. of air at maximum 40°, must be realised. This will be achieved by realising at least +180 Pascal of pressure difference between inside the apparatus and outside. Additionally, the measured temperature of the bottom plate of the drive must not exceed 50° C.

Remark: under an environmental temperature of the drive between 5° to 30° C no airflow is necessary.

Audio performance

- **Audio specification for line out:**

	On pressed CD	On recordable CD
Output Voltage	1 V rms	1 V rms
Unbalance	max 0.25 dB	max 0.25 dB
Output Impedance	470 Ohm	470 Ohm
Amplitude Linearity	1.5 dB (20 Hz - 20 kHz)	2.5 dB (20 Hz - 16 kHz)
S/N-ratio	81 dB (84 dB A-wtg)	80 dB (82 dB A-wtg)
Total Harmonic Distortion + Noise (1kHz)	65 dB	55 dB (1kHz)
Outband attenuation	min. 50 dB above 25 kHz	min. 50 dB above 25 kHz
Channel separation	min. 70 dB (20 kHz)	min. 65 dB (16 kHz)
Muting level during random access	min. 70 dB (BW = 20 kHz)	min. 70 dB (BW = 20 kHz)

- **Audio specification for headphone:**

	On pressed CD	On recordable CD
Output Voltage (max volume)	3.1 V rms	3.1 V rms
Unbalance	max 0.25 dB	max 0.25 dB
Output Impedance	120 Ohm	120 Ohm
Amplitude Linearity	1.5 dB (20 Hz - 20 kHz)	2.5 dB (20 Hz - 16 kHz)
S/N-ratio	81 dB (84 dB A-wtg)	80 dB (82 dB A-wtg)
Total Harmonic Distortion + Noise	60 dB	45 dB
Outband attenuation	min. 50 dB above 25 kHz	min. 50 dB above 25 kHz
Channel separation	min. 67 dB (20 kHz)	min. 65 dB (16 kHz)
Muting level during random access	min. 60 dB (BW = 20 kHz)	min. 60 dB (BW = 20 kHz)

NOTE: THE SOMEWHAT REDUCED AUDIO QUALITY WHEN PLAYING BACK AUDIO TRACKS ON CD-R DISCS HAS NO RELATION TO THE DIGITAL QUALITY OF THE AUDIO TRACKS AS THEY HAVE BEEN RECORDED ONTO THE CD-R DISC.

Interface Pin Table

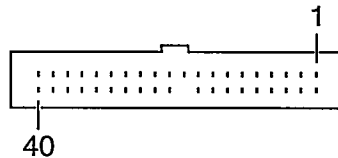

SIGNAL	PIN NUMBER	SIGNAL	PIN NUMBER
RESET	01	DMA REQUEST	21
GROUND	02	GROUND	22
-DB(7)	03	I/O WRITE	23
-DB(8)	04	GROUND	24
-DB(6)	05	I/O READ	25
-DB(9)	06	GROUND	26
-DB(5)	07	I/O READY	27
-DB(10)	08	SPSYNC:CSEL	28
-DB(4)	09	DMACK-	29
-DB(11)	10	GROUND	30
-DB(3)	11	INTRQ	31
-DB(12)	12	16 BIT I/O	32
-DB(2)	13	DA1	33
-DB(13)	14	PDIAG-	34
-DB(1)	15	DA0	35
-DB(14)	16	DA2	36
-DB(0)	17	CHIP SELECT 0	37
-DB(15)	18	CHIP SELECT 1	38
GROUND	19	DASP-	39
Removed	20	GROUND	40

APPENDIX

Jumper Block

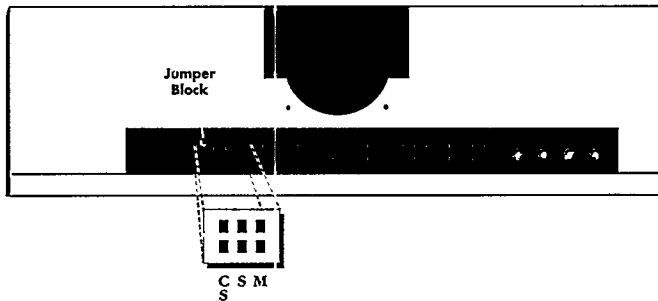

- When a shorting jumper is in the "CS" (CSEL) position, the device will use the host interface signal CSEL to configure the device.

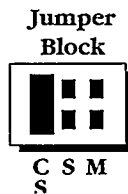

- When the shorting jumper is placed in the "M" (MASTER) or "S" (SLAVE), the drive will be configured accordingly.



OR

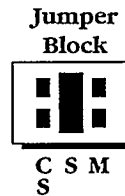

Auto selftest

- The auto selftest will execute a number of diagnostic tests and will be activated by pushing and holding Open/Close button for one complete Open/Close cycle of the tray.
- The auto selftest can also be executed by holding the Open/Close button for about 4 seconds during power-up.
- The disc-in LED and the write-LED will be tested before the actual selftest:
 - The disc-in LED will flash three times: The first time RED, the second time GREEN and the last time ORANGE.
 - The write-LED will flash ORANGE.This is repeated once.
- During execution of a particular test 0, the right LED is ORANGE. After execution of this test, the right LED will flash a number of times.
If this part of the test failed, then the LED will flash RED a number of times. The number of flashes, corresponds to the sequence number of the test.
- In case of a failing selftest, it may helpful to report the number of the failing test to your supplier.

Example : Execution of test number 4

- disc-in LED is ORANGE
 - ▶ Test 4 is being executed
- disc-in LED flashes 4 times GREEN
 - ▶ Test 4 is executed successfully

OR

- disc-in LED flashes 4 times RED
 - ▶ Test 4 failed
-
- After completion of the whole selftest, a final indication of the testresults will be given: The LED will flash GREEN-ORANGE for about 3 seconds if the test is successful. Otherwise, the LED will be RED until a new command has to be executed.

Basic principles of CD-R media

A blank CD-R disc is divided into areas (see figure below). This differs from a prerecorded disc by the additional CD-R area, which lies in front of the lead-in area.

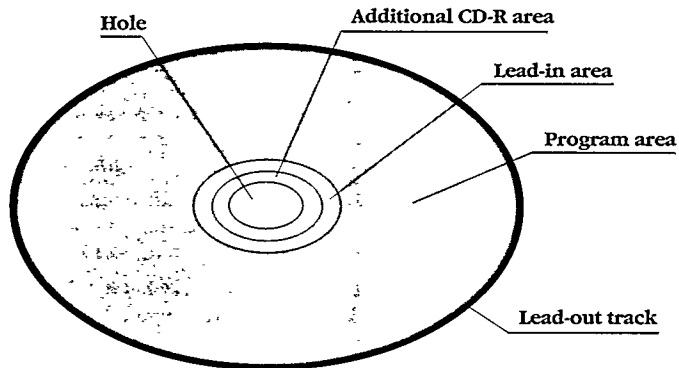

A CROSS-SECTION THROUGH A CD-R DISC

The disc comprises different layers.

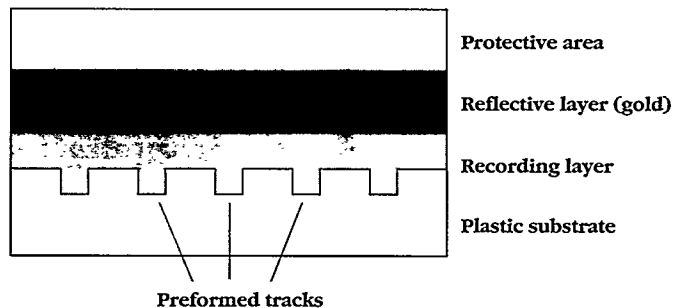

- Transparent plastics material (the same as conventional CD's) is used as the substrate.

- Onto this a special greenish tinged translucent layer is applied. The substrate has already been provided with a pre-formed track spiral into which the data will be written during recording.
- On top of the green recording layer is a reflective gold layer and a protective layer of plastic material.

The additional CD-R area of a CD-R disc

The additional CD-R area is divided into two areas:

- The Program Memory Area (PMA) which mainly contains the track numbers of the tracks recorded with respective start and stop points.
- The Program Calibration Area (PCA). Disc space for the CD writer to calibrate the laser energy needed for recording on the disc via a trial recording.

A CROSS-SECTION THROUGH A BLANK CD-R DISC.

Next to the centre hole is an area for the mechanical clamping of the disc in the player. Adjacent to this is the unrecorded area of the blank CD-R disc.

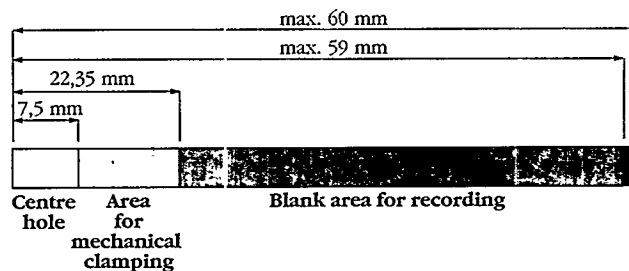

A CROSS-SECTION THROUGH A PARTIALLY RECORDED CD-R DISC.

After the first recording the recording area is divided (see figure below).

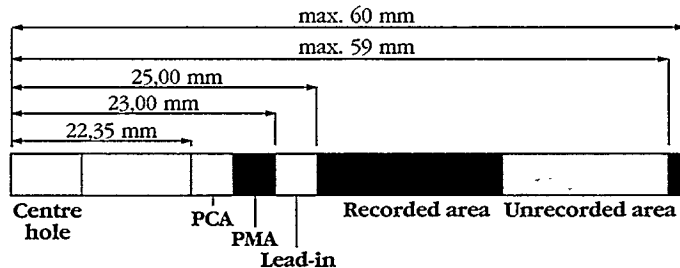

- The "Lead-in", "program area" and "Lead-out" areas are present on every conventional prerecorded CD.
- For the partially recorded CD-R disc, the PCA and PMA areas are incorporated in front of the Lead-in.
- Track numbers with associated absolute start and stop times are stored in the PMA.

The possibility exists of making further recordings later. It would also be possible to declare the disc as fully recorded. In which case, the definitive table of contents (TOC) is written into the Lead-in.

A CROSS-SECTION THROUGH A FULLY RECORDED CD-R DISC.

The fully recorded CD-R disc has a program of 74 minutes playing time, a lead-in area with table of contents and a lead-out area.

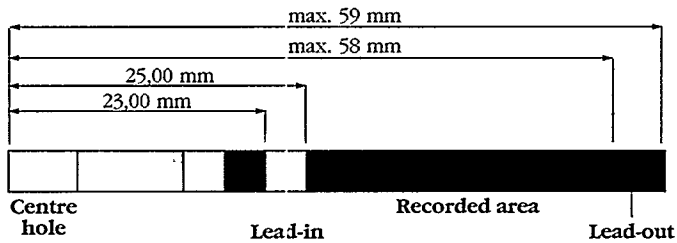

- The areas specific to the CD recorder, the PCA and PMA, are still present but are simply not used by conventional CD players.
- When the lead-in area is provided with the table of contents, the CD recorder uses the information stored here and not the data from the PMA area.
- Identification of the end of the disc is stored in the Lead-out. The CD player stops playback of a disc when reaching this area.

Glossary of terms CD-RW

THE BEST WAY TO CREATE YOUR OWN CDs - WITH RE-USABLE CD-RW.

- CD-ReWritable (CD-RW) gives you the opportunity to create your own CDs, in the best and most cost-effective way. CD-RW is, in fact, the logical extension of the promise already made by Philips CD-Recordable (CD-R). Together, they give you the opportunity to run the media that best suits the job in hand.
- CD-RW supports the recording of small packages of data, using incremental packet writing in the universal (UDF) file format. As with floppy discs, you have the option of writing a disc all at once, or building it up bit by bit - and re-using the disc later for other data.
- CD-RW media can be rewritten hundreds, or even thousands of times. This means that the overall running costs, for hardware and software together, can be very economical indeed.
- CD-RW will greatly extend your personal short-term storage capacity, providing space for large-volume files like Internet downloads, backups, and hard disc dumps. It is also excellent for low-quantity multimedia applications, from one-off disc testing to small-scale distribution

MULTIREAD: MAKING CD-RW MEDIA COMPATIBLE WITH CD-ROM AND DVD-ROM.

- Compatibility and interchangeability have always been the cornerstones of CD. To ensure that CD-RW is no exception, Philips and Hewlett-Packard worked together to specify MultiRead.
- CD-RW media reflects less laser light than the other CD media. To play all CD media, drives must be able to adapt to these different reflectivities.

- For compatibility, drives need to do this in a standard way. They also need to interface and interact with their host computer systems in a standard way.
- That standard way is MultiRead. And any CD drive can play all CD media - CD-Digital Audio, CD-ROM, CD-R, and CD-RW - provided that it supports MultiRead.
- What is more, MultiRead extends the same compatibility to DVD. All DVD equipment that supports MultiRead will also be able to retrieve CD-RW data. This means that you can go ahead now with storing valuable data on CD-RW media, safe in the knowledge that it will be future-proof.

Glossary of terms CD-R

Copyright acknowledgment: This part contain material from "OSTA - Optical Storage Technology Association". Published with permission.

"Optical Storage Technology Association"

*311 East Carrillo Street
Santa Barbara, CA - USA
Tel: (805) 963 3853
Fax: (805) 962 1541*

World Wide Web homepage: <http://www.osta.org>

WHAT IS CD-RECORDABLE?

- CD-Recordable is compact disc technology that allows the user to create their own CD's. This is done by means of a recording system that uses "Write once" type optical discs standardized by Philips and Sony and documented in the "Orange Book, Part II" and a CD recording device that is connected to a host system. Typically, the host system is a personal computer which also contains recording software.

WHAT IS THE ORANGE BOOK?

- The Orange Book is a document that describes the specification for CD-Write Once (CD-Recordable) technology developed by Philips and Sony.
- It defines both the physical structure and dimensions of a CD-R disc as well as the use of certain portions of the recording surface:
 - to record information (the Program area),
 - to calibrate the recorder laser power (Power Calibration area or PCA),
 - to record track information for all sessions (the Program Memory area or PMA),
 - to record the Lead-in Lead-out areas that precede and follow, respectively, the Program area.
- There are several “parts” to the Orange Book. Part II refers to CD-Recordable.

WHAT DOES ORANGE BOOK CERTIFIED MEDIA MEAN AND WHY?

- The Orange Book, Part II is the primary specification for CD-R media. Accordingly, all CD-R media should meet the Orange Book criteria for recordability and playback.
- Philips and Sony, the originators of the Orange Book, provide Orange Book certification of CD-R media.

WHAT IS MULTISESSION CD?

The principal purpose of multiple sessions is to allow additional data to be appended to a previously recorded disc.

NOTE: SOME OLDER CD READERS CAN READ ONLY THE FIRST SESSION OF A MULTISESSION DISC.

A session is defined as an area including lead-in, program data and lead-out.

- A CD-R recorder that supports multisession recording can write a disc that will have multiple sessions linked together, each containing their own lead-in, program and lead out.
- Any multisession-supported CD reader can access the data, whether it was written in the first session or a subsequent session.

Contrast this to the recording structure of a pressed CD-ROM or a CD-R written in "Disc at Once" mode that contains just one lead-in area and one lead-out area.

WHAT IS THE RECORDING SPEED OF CD-R?

The "speed" rating of a CD-Recordable/Rewritable determines how fast it can record data to blank CD-R media.

Speed designators, such as "1X", "2X", "4X" and "6X" define multiples of the original playback speed of first generation CD-ROM players:

- For a CD-ROM player or CD-Recordable/Rewritable, a 1X speed translates to 153,600 Bytes per second. This is usually rounded down to 150 Kb per second. Therefore, a "1X" recorder writes 150 Kb per second to the CD-R media.
- Likewise, a "2X" recorder records at 300 Kb per second.
- A "4X" records at 600 Kb per second.
- A "6X" records at 900 Kb per second.

NOTE: THERE ARE SOME VARIATIONS IN MEASURING SPEED, BECAUSE THERE ARE RECORDING MODES THAT PROVIDE MORE THAN 2,048 DATA BYTES PER BLOCK (AUDIO IS RECORDED AT 2,352 BYTES PER BLOCK).

NOTE: SOME CD-RECORDABLE/REWITABLES HAVE A DIFFERENT READING SPEED THAN THEIR RATED RECORDING SPEED. FOR INSTANCE, A "2X6" CD-RECORDABLE / REWITABLE CAN WRITE AT 2X SPEED AND READ BACK AT 6X SPEED (900 KB PER SECOND).

COMPACT DISC AVERAGE TRANSFER RATES

Note 1: The normal CD transfer rate from the disc is 75 blocks per second.

Note 2: The average transfer rates shown are in BYTES PER SECOND.

Read/Write Speed	Audio (2,352 Bytes/Block)	CD-ROM Mode 1 (2,048 Bytes/Block)	CD-ROM Mode 2 (2,336 Bytes/Block)
1X	176,000	153,600	175,200
2X	352,800	307,200	350,400
4X	705,600	614,400	700,800
6X	1,058,400	921,600	1,051,200

Read/Write Speed	CD-i & (XA) Form 1 (2,048 Bytes/Block)	CD-i & (XA) Form 2 (2,324 Bytes/Block)
1X	153,600	174,300
2X	307,200	348,600
4X	614,400	697,200
6X	921,600	1,045,800

Source: Craig Schwarz, Eastman Kodak Company

WHAT IS THE DIFFERENCE BETWEEN CD-R "FIXATION" AND "FINALIZATION"?

- Fixation is the process of writing the lead-in and lead-out information to the disc. This process finishes a writing session and creates a table of contents.
- Fixation is required for a CD-ROM or CD-Audio player to play the disc. Discs which are "fixated for append" can have additional sessions recorded, with their own session lead-in and lead-out, creating a multisession disc.
- When a disc is "finalized" the absolute lead-in and lead-out for the entire disc is written, along with information which tells the reader not to look for subsequent sessions.

This final table of contents (TOC) conforms to the ISO 9660 file standard.

WHAT IS "DISC AT ONCE"?

- Disc at Once is a writing mode that requires data to be written continuously, without any interruptions, until the entire data set is transferred to the CD-R.
- The lead-in, program and lead-out are written in a single event. All of the information to be recorded needs to be staged on the computer's hard disk prior to recording in the Disc at Once mode.
- This mode is usually preferred for discs that are sent to a CD-ROM replication facility when CD-R is the source media.
- Recording in the Disc at Once mode eliminates the linking and run-in and run-out blocks associated with multisession and packet recording modes, which often are interpreted as uncorrectable errors during the glass mastering process.

WHAT IS "TRACK AT ONCE"?

- Track at Once is a writing mode that allows a session to be written in a number of discrete write events, called tracks.
- The disc may be removed from the writer and read in another writer (given proper software) before the session is fixated.

The written sessions contain complete "tracks" of information.

WHAT IS "INCREMENTAL" OR "PACKET" WRITING?

- Track at Once writing is a form of incremental write which mandates a minimum track length of 300 blocks and a maximum of 99 tracks per disc.

- A track written “at once” has 150 blocks of overhead for run-in, run-out, pre-gap and linking. Packet write, on the other hand, is a method whereby several write events are allowed within a track, thus reducing the overhead.

These “packets” are bounded by 7 blocks for run-in (4), run-out (2) and link (1).

WHAT'S THE DIFFERENCE BETWEEN A “MULTISESSION” DISC AND A “MULTITRACK” DISC?

- A “session” is a unity on a CD which is bounded by lead-in and lead-out. A session contains one or several (up to 99 per disc) tracks.
- There are two types of tracks. A Red Book audio track is usually written in disc at once mode along with several other tracks in one session. These tracks have index numbers in the subchannel which differentiate one from the other and which allow selective playback.
- The other type of track is the incrementally written type described above.

Other information

For other information on Philips CD-Recordable/Rewritable products, please consult the following BBS (Bulletin Board System) or Internet sites:

BBS: +31/40/273 11 12

Internet (USA)
<http://www.pps.philips.com>

Internet (worldwide)
<http://www.philips.com>

EUROPEAN SUPPORT NUMBERS

Austria	0660-8142
Belgium	0800-15532
Denmark	800-17941
Finland	08001-13170
France	0800-917909
Germany	0130-823983
Greece	00800-311207
Ireland	1-800-553178
Italy	1678-79499
Netherlands	06-8406
Norway	800-11365
Luxembourg	0800-2974
Portugal	0505313338
Spain	900-983181
Sweden	020-795344
Switzerland	0800-553497
United Kingdom	0800-966185

Faxnumber: +31 53 4850062



The products and services described herein are not necessarily available in all countries. Due to continuous product improvements this document is subject to change without notice. Printed in Belgium.

© PHILIPS 1997

All trademarks acknowledged.