

PHILIPS

CD 753 Compact Disc Player

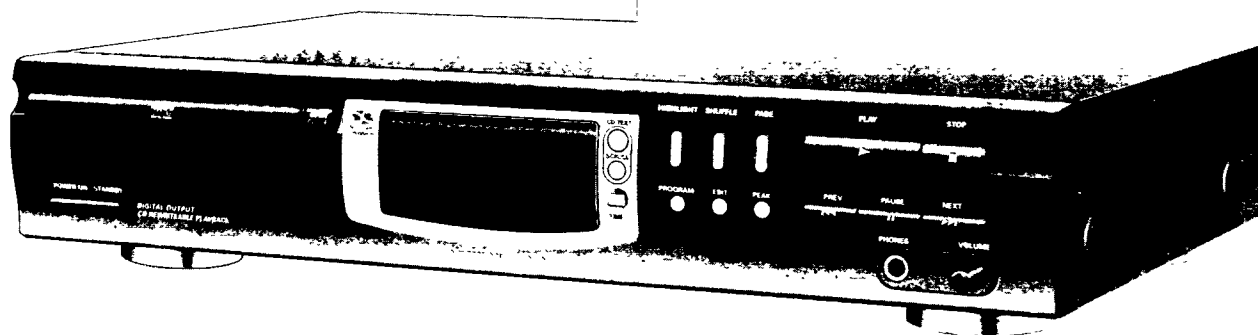

Instructions for use
Mode d'emploi
Instrucciones de manejo
Manual de instruções
使用説明書



PHILIPS

AUSTRALIA

Philips product warranty for Australia

Warranty conditions valid for Colour Television, Video Cassette Recorders, Audio Systems, and Portable Audio.

The benefits given to the purchaser by this warranty are in addition to all other rights and remedies which the purchaser has in respect of the product under the Trade Practices Act or other Commonwealth or State Law.

Philips Sound and Vision warrants its products to the purchaser as follows and subject to the stated conditions.

12 months free service

Any defect in materials or workmanship in the product occurring within 12 months from the original date of purchase will be rectified free of charge by Philips Service or one of our authorised service centers.

Conditions of warranty

1. All claims for warranty service should be made to your nearest Philips Service Branch or to a Philips authorised service dealer. Reasonable evidence of date of purchase must be provided.
2. This warranty extends only to defects occurring under normal use of the product when operated in accordance with the instructions.
3. Home service within the normal service area of Philips Service or one of our authorised service centres will be provided for television receivers with screen size 59cm and above. All other products are to be brought or sent to your nearest Philips Service Branch or to an authorised service centre.
4. This warranty does not cover:
 - a) Mileage or traveling time, pickup or delivery, cost of insurance.
 - b) Service costs arising from failure to correctly adjust the controls of the product or to observe the instructions, or inspections that reveal that the product is in normal working order.
 - c) Product failures caused by misuse, neglect, normal wear and tear, accidental breakage, transit damage, inexpert repairs or modification by unauthorised persons, lightning strikes, vermin infestation or liquid spillage.
 - d) Cleaning of video or audio heads.
 - e) Inadequate receiving antennae.
 - f) Replacement of worn or used batteries, styli or other consumables.

The conditions contained in this warranty replace and override the provisions of the World-Wide Guarantee for Products sold in Australia.

Philips Service Branches

To contact your nearest Philips Service Branch call **13 13 92** from anywhere in Australia.

Sydney
Technology Park
Australia Centre
3 Figtree Drive
Homebush NSW 2140

Newcastle & Central Coast
984 Hunter Street
Newcastle West NSW 2302

Perth
1 Fredrick Street
Belmont WA 6104

Melbourne
Cnr Wellington &
Springvale Roads
Mulgrave VIC 3170

Brisbane
10 Graystone Street
Tingalpa QLD 4173

Also Service Centres:
Adelaide

348 Torrens Road
Croydon Park SA 5003

Hobart
2A Pierce Street
Moonah TAS 7009

Wollongong
1/216 Cornmal Street
Wollongong NSW 2500

Canberra
Unit E,
66-70 Maryborough Street
Fyshwick ACT 2609

Service is also provided through 1,200 accredited service dealers throughout Australia. To find out about your nearest centre, call **13 13 92**.

Call us direct on the Philips Customer Helpline

Philips customer care lasts as long as you keep the product. Whenever you need any information on the care or operation of your product, remember it's always best to go straight to the source. Phone Philips Helpline direct on

13 13 91
7 days a week

— your call is always welcome.

Please record the following information for your records and keep in a safe place

Model No:.....

Serial No:.....

***Please retain your purchase receipt which is
required to claim service under warranty.***

Philips Electronics Australia Limited
ACN 008 445 743, 3 Figtree Drive
Homebush NSW 2140

Vers on 2, 03/97, FFCP-000

NEW ZEALAND

Guarantee and Service for New Zealand

Thank-you for purchasing this quality Philips product. Philips New Zealand Ltd guarantees this product against defective components and faulty workmanship for a period of 12 months. Any defect in materials or workmanship occurring within 12 months from the date of purchase subject to the following conditions will be rectified free of charge by the retailer from whom this product was purchased.

Conditions

1. The product must have been purchased in New Zealand. As proof of purchase, retain the original sales docket indicating the date of purchase.
2. The guarantee applies only to faults caused by defective components, or faulty workmanship on the part of the manufacturer.
3. The guarantee does not cover failures caused by misuse, neglect, normal wear and tear, accidental breakage, use on the incorrect voltage, use contrary to operating instructions, or unauthorised modification to the product or repair by an unauthorised technician.
4. Reasonable evidence (in the form of a sales docket) must be supplied to indicate that the product was purchased no more than 12 months prior to the date of your claim.

5. In the event of a failure, Philips shall be under no liability for any injury, or any loss or damage caused to property or products other than the product under guarantee.

This guarantee does not prejudice your rights under common law and statute, and is in addition to the normal responsibilities of the retailer and Philips.

How to claim

Should your Philips product fail within the guarantee period, please return it to the retailer from whom it was purchased. In most cases the retailer will be able to satisfactorily repair or replace the product.

However, should the retailer not be able to conclude the matter satisfactorily, or if you have other difficulties claiming under this guarantee, please contact

The Guarantee Controller
Philips New Zealand Ltd.

☐ P.O. Box 41.021

Auckland

☎ (09) 84 94 160

fax ☎ (09) 84 97 858

English	4	English
Français.....	13	Français
Español	22	Español
中文.....	31	中文

MEXICO **NOM**

Es necesario que lea cuidadosamente su instructivo de manejo.

	PRECAUCIÓN - ADVERTENCIA No abrir, riesgo de choque eléctrico	
	ATENCIÓN Verifique que el voltaje de alimentación sea el requerido para su aparato	
Para evitar el riesgo de choque eléctrico, no quite la tapa. En caso de requerir servicio, dirijase al personal calificado.		

Garantía para México

Este aparato está fabricado con materiales de alta calidad y ha sido cuidadosamente verificado. Philips, por lo tanto, da a usted una garantía de 12 meses a partir de su fecha de compra.

La garantía ampara la reposición de las piezas defectuosas debidas a fallas en su montaje o en los materiales, incluyendo la mano de obra necesaria para su reemplazo en nuestras Sucursales o talleres autorizados.

En caso de fallas en su aparato le rogamos se sirva poner en contacto con su distribuidor.

Esta garantía no cubrirá las averías que resulten como consecuencia de una instalación incorrecta del aparato, manifiesto maltrato o uso inadecuado del mismo.

Philips se obliga a reparar y devolver a usted su aparato en un plazo no mayor de 30 días hábiles contados a partir de la fecha de haber ingresado su aparato a uno de nuestros talleres.

Para que esta garantía sea válida, es necesario que el certificado que figura en la parte posterior de este instructivo haya sido debidamente llenado en el momento de la compra del aparato.

En caso de extravío del certificado con la presentación de la factura o remisión de su aparato podrá hacer efectiva la garantía correspondiente.

Si usted tiene alguna duda o pregunta que no le pueda solucionar su distribuidor, por favor ponerse en contacto con:

Centro de Servicio Philips
Bldv. de los Ferrocarriles No.339
Col. Industrial Vallejo, 02300
México, D.F.
☎ 728-42 00

Centro de Información al Consumidor
☎ 368-77 88 ó 91 (800) 504-62 00

GENERAL INFORMATION

Table of contents

GENERAL INFORMATION

Maintenance	4
Technical data	4

CONTROLS AND CONNECTIONS

Controls on the front	5
Connections at the back	5
At the bottom	5

INSTALLATION AND REMOTE CONTROL

Accessoires	6
Connections	
Usual connection, LINE OUT	6
Digital connection, DIGITAL OUT	6
Mains	6
Remote control	6
Batteries	6

PLAYBACK

CD Text	7
Playing a CD	7

ADDITIONAL FUNCTIONS

Selecting a track and searching	
Selecting a track during CD play	8
Selecting a track when CD play is stopped	8
Searching for a passage during CD play	8
Random order playing (SHUFFLE)	8
Repeating a CD, a track or a program	8
Repeating a part of the CD	8
Programming track numbers	9
Clearing the program	9
Loudest passage searching	9
Time display	9
Fading out and in	10
Volume adjustment	10
Locking the volume	10
Headphone listening	10
Scanning the CD	10
Recording setup	11
<i>Environmental information</i>	11

TROUBLESHOOTING

Warning	12
Troubleshooting	12



Maintenance

Clean the CD player with a soft, slightly dampened lint-free cloth. Do not use any cleaning agents as they may have a corrosive effect.

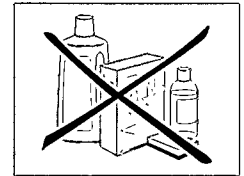

Do not expose the CD player, batteries or CDs to humidity, rain, sand or excessive heat (caused by heating equipment or direct sunlight).

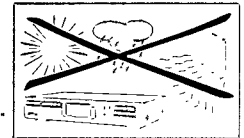

This CD player can play all kinds of Audio Discs such as CD-Recordables, CD-Rewriteables and CD-Text CDs. Do not try to play a CD-ROM, CD-I, CDV or computer CD.

If the CD player cannot read CDs correctly use a commonly available cleaning CD to clean the lens before taking the CD player to repair. Other cleaning methods may destroy the lens. Always keep the tray closed to avoid dust on the lens.

The lens may cloud over when the CD player is suddenly moved from cold to warm surroundings. Playing a CD is not possible then. Leave the CD player in a warm environment until the moisture evaporates.

To clean a CD, wipe it in a straight line from the center toward the edge using a soft, lint-free cloth. A cleaning agent may damage the disc! Never write on a CD or attach a sticker to it.



Technical data

Subject to modification without notice.

Standby power consumption	< 5W
Frequency range	20–20,000Hz
Amplitude linearity	< 0.5dB (1kHz, -90dB)
Dynamic range	100dB (1kHz)
Signal-to-noise ratio	108dB (1kHz, A-weighted)
Channel separation	98dB (1kHz)
Total harmonic distortion	0.004%, -88dB (1kHz)
Audio output	2V RMS ±3dB, 1kΩ
Digital coaxial output	75Ω acc. IEC 958
Impedance headphones	30–600Ω (5V e. m. f. from 120Ω)
Dimensions	435 × 86 × 265mm
Weight	2.9kg

CONTROLS AND CONNECTIONS

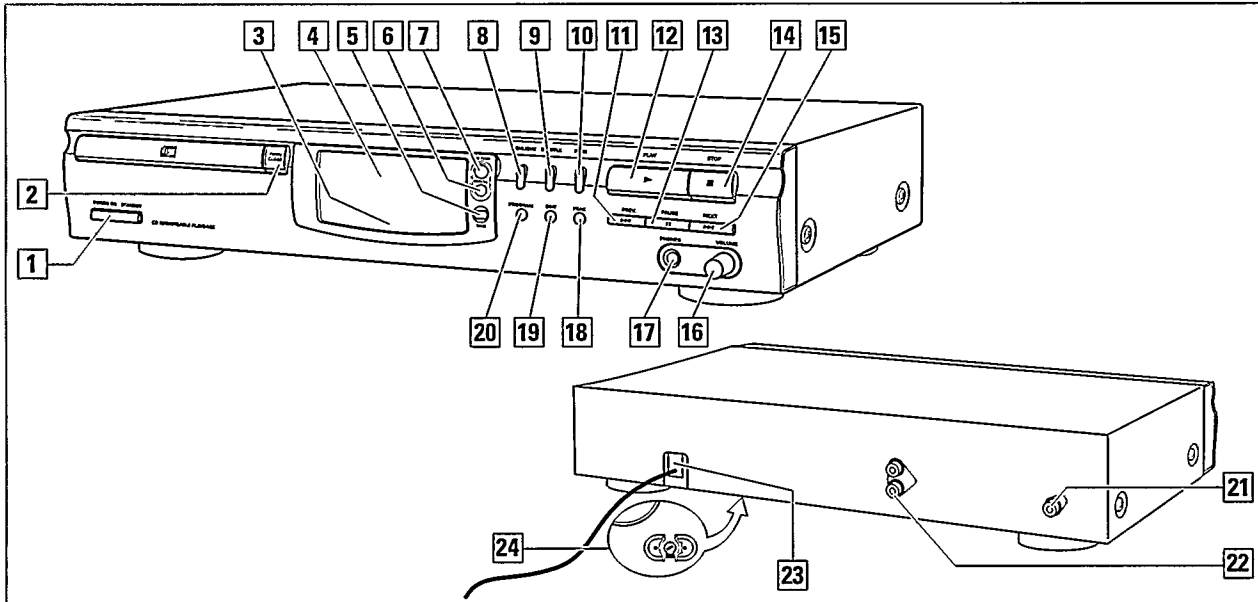

Controls on the front

- 1 POWER ON / STANDBY**.....switches the CD player on and to standby
- 2 OPEN-CLOSE**.....opens and closes the CD tray
- 3** Sensor for the infrared remote control
- 4** Display
- 5 TIME**.....switches through the different time information
- 6 SCROLL**.....scrolls CD-Text information
- 7 CD TEXT**.....switches through the different CD-Text information
- 8 HIGHLIGHT**.....plays the beginning of each track or – if a CD-Text disc contains highlights – the highlights of a CD
- 9 SHUFFLE**.....plays a CD or a program in random order
- 10 FADE**.....fades CD play out and in
- 11 PREV. ◀◀**.....selects the beginning of the current or a previous track, and searches backward
- 12 PLAY ▶**.....starts CD play
- 13 PAUSE II**.....interrupts CD play
- 14 STOP ■**.....stops CD play and clears a program
- 15 NEXT ▶▶**.....selects the beginning of a subsequent track, and searches forward

- 16 VOLUME**.....decreases or increases the volume level of the headphones
- 17 PHONES**.....6.3mm headphone socket
- 18 PEAK**.....searches the loudest passage of a CD
- 19 EDIT**.....changes the settings for recording on tape or CD-Recordable
- 20 PROGRAM**.....programs track numbers

Connections at the back

- 21 DIGITAL OUT**.....to connect the digital input of a digital audio device
- 22 LINE OUT L R**.....to connect the audio input of an amplifier
- 23 Mains lead**.....After all other connections have been made, connect this mains lead to the wall socket.

At the bottom

- 24 VOLTAGE SELECTOR**.....(Not on all versions.) Disconnect the mains lead first, if this selector must be reset.

INSTALLATION AND REMOTE CONTROL

Accessories

This CD player is supplied including:

- a remote control
- 2 batteries for the remote control
- a connection cable
- this instruction booklet

Connections

Usual connection, LINE OUT

- 1 Insert the red plug of the supplied connection cable into R and the other plug into L.
- 2 Insert the other side of the cable into the corresponding sockets of the CD or AUX input of your amplifier.

Important!

You may also use the TUNER or TAPE, but **never** the PHONO input of your amplifier!

Digital connection, DIGITAL OUT

Never connect this socket to a non-digital input – such as AUX, CD, PHONO, TAPE – of an amplifier. This output supplies a digital signal and can therefore only be connected to a digital input.

- 1 Insert an optional coaxial cable into DIGITAL OUT.
- 2 Insert the other side of the cable into the digital input of your digital device (e. g. CD Recorder).

Mains

The type plate is located on the back of the CD player.

- 1 If your set is equipped with a VOLTAGE selector (at the bottom), set this selector to your local mains voltage if necessary. *Position 120V includes 110V–127V. Position 230V includes 220V–240V.*
- 2 Connect the mains cable to the wall socket. This switches on the mains supply.

Note: To disconnect the CD player from the mains completely, remove the mains plug from the wall socket.

Remote control

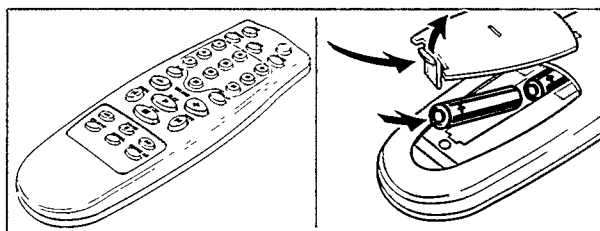

Batteries

- Open the battery compartment of the remote control and insert 2 alkaline batteries, type **AAA** (R03, UM-4).

Remove batteries if they are flat or the remote control is not going to be used for a long time.

Batteries contain chemical substances, so they should be disposed of properly.

- TIME**switches through the different time informations
- ⏻**switches the CD player to standby
- PROGRAM**programs track numbers
- FADE**fades CD play out and in
- SHUFFLE**plays a CD or a program in random order
- Digits 1–0**selects a track by number
- HIGHLIGHT**plays the beginning of each track or – if a CD-Text disc contains highlights – the highlights of a CD
- REPEAT**repeats a track, a program or the entire CD
- VOLUME –**decreases the volume level
- VOLUME +**increases the volume level
- PLAY ▶**starts CD play
- PREV. ◀**selects the beginning of the current or a previous track
- NEXT ▶**selects the beginning of a subsequent track
- STOP ■**stops CD play and clears a program
- ◀◀**searches backward
- PAUSE II**interrupts CD play
- ▶▶**searches forward
- CD TEXT**switches through the different CD-Text information
- SCROLL**scrolls CD-Text information
- REPEAT A/B**repeats a selected part of the CD

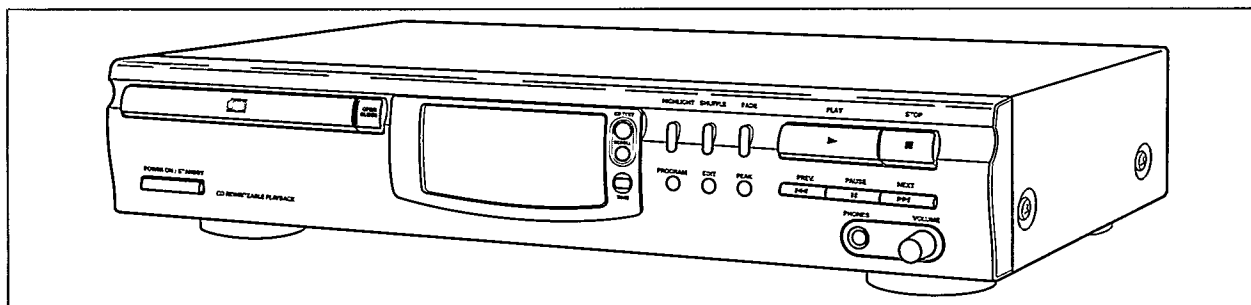

CD-Text

This CD player can show information which is stored on CD-Text discs. It will only reproduce the text which is recorded on the disc.

- 1 When inserting a disc with CD-Text the display shows **CD TEXT** and performing artist or group. In case there are various artists the album title is shown.
- 2 Press **CD TEXT** before playing a CD to switch between album title and performing artist(s) if available.
- 3 Press **CD TEXT** during CD play to switch between album title, performing artist(s) and track title if available.
- 4 At the beginning of a new track the track title is scrolled once. Then the first 12 digits of the track title are displayed.
- 5 CD-Text information is scrolled every 30 seconds. Press **SCROLL** to scroll the text through the display any time.

Playing a CD

- 1 Use **POWER ON / STANDBY** to switch on the CD player.
- 2 Press **OPEN-CLOSE** to open the CD tray.
→ **OPEN** appears on the display.
- 3 Insert an audio CD (printed side up) and press **OPEN-CLOSE** to close the CD compartment.
→ **READING** appears on the display. Then the number of tracks and the playing time is shown. If the disc contains CD-Text the display shows **CD TEXT** and CD-Text information (see "CD-Text").
- 4 Press **PLAY** ▶ to start CD play.
→ The display shows ■■■, **TRACK**, **TIME**, and the number and time of the actual track. If the disc contains CD-Text the display shows CD-Text information.
 - You can interrupt CD play by pressing **PAUSE** ■■.
→ The display shows ■■■ ■■ and the track number and time where playback was stopped.
 - Continue CD play by pressing **PAUSE** ■■ again.
- 5 Press **STOP** ■ to stop CD play.

Note: Playback will also stop if the end of the CD is reached.

ADDITIONAL FUNCTIONS

English

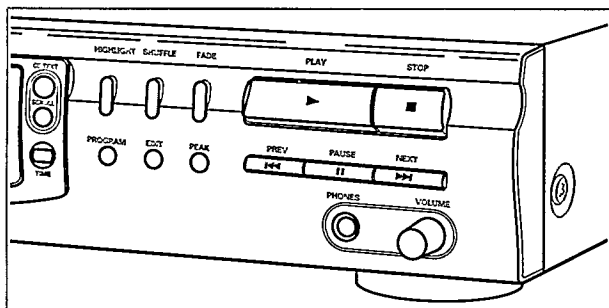

Selecting a track and searching

Selecting a track during CD play

- Briefly press PREV. ◀◀ or NEXT ▶▶ (PREV. ◀ or NEXT ▶ on the remote control) once or several times to skip to the beginning of the current, previous or subsequent track(s).
- or
- Use the digits 1–0 on the remote control to key in the number of a track.
→ CD play continues with the selected track.

Selecting a track when CD play is stopped

- 1 Briefly press PREV. ◀◀ or NEXT ▶▶ (PREV. ◀ or NEXT ▶ on the remote control) once or several times.
- or
- Use the digits 1–0 on the remote control to key in the number of a track.

- 2 Press PLAY ▶ to start CD play.
→ Playback starts with the selected track.

Searching for a passage during CD play

- 1 Hold down PREV. ◀◀ or NEXT ▶▶ (◀◀ or ▶▶ on the remote control) to find a particular passage in a backward or forward direction.
→ CD play continues at a low volume.
- 2 Release the button when you have reached the desired passage.

Note: In the shuffle and repeat mode and when playing a program, searching is only possible within the particular track.

Random order playing (SHUFFLE)

- 1 Press SHUFFLE before or during CD play to start shuffle play.
→ SHUFFLE is shown in the display. All the tracks of the CD (or program if available) will now be played in random order.
- 2 Press SHUFFLE again to return to normal CD play.

Repeating the CD, a track or a program

- 1 Press repeatedly REPEAT on the remote control during CD play.
→ The display shows the different repeating modes.
REPEAT 1: the current track is played repeatedly.
REPEAT: the entire CD or program (if available) is played repeatedly.
- 2 Press REPEAT until the display indication disappears to return to normal CD play.

Note: It is possible to activate the different playing modes at the same time, e. g. you can repeatedly play the entire CD or program in random order (PROGRAM REPEAT SHUFFLE).

Repeating a part of the CD

- 1 Press PLAY ▶ to start CD play.
- 2 Press REPEAT A/B on the remote control to mark the beginning of the passage to be repeated.
→ REPEAT is shown and A- is flashing in the display.
- 3 Press REPEAT A/B on the remote control to mark the end of the passage to be repeated.
→ REPEAT A-B is shown in the display. The part of the CD between the marked points is played repeatedly.
- 4 Press PLAY ▶ to return to normal CD play.

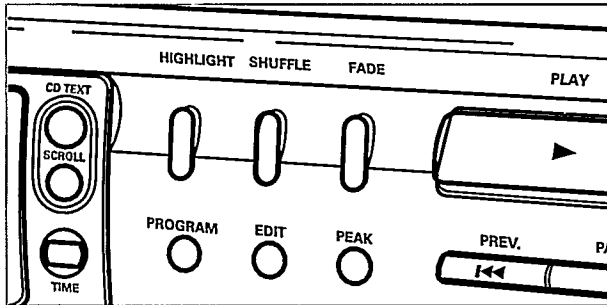

Programming track numbers

You can select a number of tracks and store these in the memory in the desired sequence. You can store any track more than once. At most, 30 tracks can be stored in the memory.

- 1 Press PROGRAM to start programming.
→ PROGRAM flashes.

Note: If you press PROGRAM while playing a CD, the actual track will be added to the program.

- 2 Press PREV. ◀◀ or NEXT ▶▶ (PREV. ◀ or NEXT ▶ on the remote control) to select the desired track.
or
 - Key in the number of a track with the digits 1-0 on the remote control.
- 3 Press PROGRAM to store the track number.
→ TRACK, TOTAL TIME, and the number of the programmed track is displayed. The number of programmed tracks is increased and the time of the track is added to the total time of the program.
- 4 Repeat steps 2 and 3 for all tracks to be programmed.
- 5 Press STOP ■ to end programming.
→ PROGRAM lights permanently.
 - It is possible to review the program using the PREV. ◀◀ or NEXT ▶▶ (PREV. ◀ or NEXT ▶ on the remote control). You can add more tracks by pressing PROGRAM like you have done before.
- 6 Press PLAY ▶ to start program play.

Note: If you try to store more than 30 tracks PROGRAM FULL scrolls through the display.

Clearing the program

- 1 If necessary press STOP ■ to stop program playing.
- 2 Press STOP ■ to clear the program.
→ PROGRAM CLEARED scrolls through the display, PROGRAM disappears and your program is cleared.

Note: The program will also be cleared if you open the tray.

Loudest passage searching

You can search for the loudest passage of a CD or program. This will help you in adjusting your recording device if required.

- 1 If necessary press STOP ■ to stop CD play.
- 2 Press PEAK to start searching.
→ PEAK starts flashing. Searching may need a few minutes. Then 4 seconds of the loudest passage are played repeatedly.
 - You can interrupt peak play by pressing PAUSE ||. Continue peak play by pressing PAUSE || again.
- 3 Press STOP ■ to stop playing.
or
 - Press PLAY ▶ to start CD play.

Time display

You can display time information which is stored on the CD.

While playing a CD or a program the number and elapsed time of the actual track, and TIME are displayed. If the disc contains CD-Text the display shows CD-Text information (see "CD-Text").

- Press TIME several times to display:
 - If the disc contains CD-Text, the number and elapsed time of the actual track, and TIME are displayed first.
 - The number and remaining time of the actual track, and REM TIME.
 - The number of the actual track, the total elapsed time of the CD, and TOTAL TIME.
 - The number of the actual track, the total remaining time of the CD, and TOTAL REM TIME.

Note: If you press TIME when the CD is not playing you may only display the total time of the CD.

ADDITIONAL FUNCTIONS

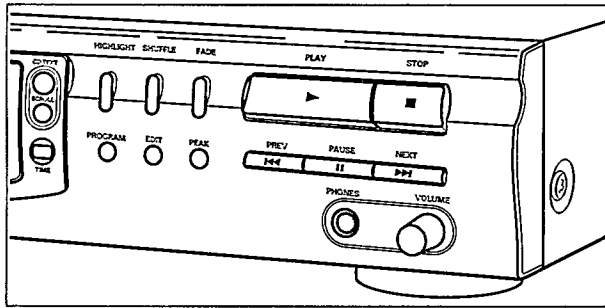

Fading out and in

You can fade out and in CD play, e. g. to stop and start a recording softly.

- 1 Press FADE during CD play to fade out.
→ The display shows ■■■■ in steps. The volume is lowered continuously until CD play is paused.
- 2 Press FADE again to fade in.
→ The display shows ■■■■ in steps. CD play starts and the volume is raised continuously to its previous level.

Note: You may use FADE anytime when CD play is paused to fade in.

Volume adjustment

The volume of the CD player can be adjusted. This affects the DIGITAL OUT output as well.

- Press VOLUME – or VOLUME + on the remote control.
→ The volume of the CD player is lowered or raised. The display shows the actual value between VOLUME MIN and VOLUME MAX.

Important!

VOLUME –/+ is altering the signal of the output. Before recording set the volume to VOLUME MAX and do not change during recording.

Locking the volume

It is possible to lock the output volume to its maximum. This affects the DIGITAL OUT output as well. Locking the volume can be useful when recording from the CD-player.

- Keep EDIT pressed for more than 2 seconds.
If the volume was unlocked:
→ The display shows VOLUME FIXED and the volume is locked.
If the volume was locked:
→ The display shows VOLUME MAX and the volume is unlocked.

Note: If you press VOLUME –/+ and the volume is locked the display shows VOLUME FIXED.

Headphone listening

- 1 Connect your headphones to the 6.3mm PHONES socket.
- 2 Use VOLUME to adjust the volume of the headphones.

Note: The maximum volume on the headphones is set through VOLUME –/+ on the remote control.

Important!

The volume of the headphones is in line with the volume of the output. Therefore do not use VOLUME –/+ during recording.

Scanning the CD

It is possible to listen to the beginning of each track of a CD or program. You can choose whether to play 10, 20 or 30 seconds of each track. If a disc contains CD-Text highlights this part of the tracks is scanned and HIGHLIGHT is displayed.

- 1 Press HIGHLIGHT repeatedly to switch through the different scan modes.
→ HIGHLIGHT, SCAN 10, SCAN 20, SCAN 30, SCAN OFF ... (SCAN OFF aborts the scan function).
- 2 As soon as the desired scan mode is displayed do not press the button again.
→ After 1 second scanning starts. The number and remaining time of the actual track, and REM TIME are displayed.
 - You can interrupt scan by pressing PAUSE ■■ . Continue scan by pressing PAUSE ■■ again.
- 3 Press STOP \blacksquare to stop scanning.
or
• Press PLAY \blacktriangleright to start CD play with the actual track.

Note: If you press HIGHLIGHT while SHUFFLE is active, shuffle will be stopped before scanning.

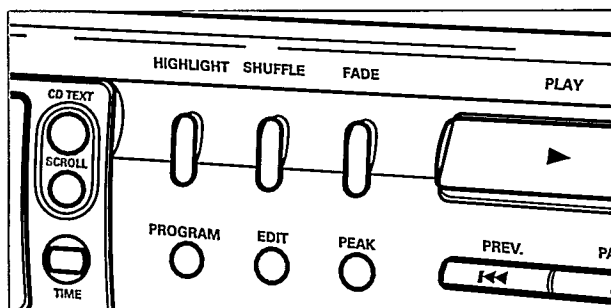

Recording setup

It is possible to set up the CD player in a way that it will calculate which tracks will fit on your recording media. It is only possible to use the edit function if a disc has not more than 29 tracks.

If you use *NORMAL* the recording stops after the last track that fits on one side of your recording media. Notice that CD-Recordables are single-sided only! If you use *OPTIMAL* some tracks will be skipped to minimise the unused space on your recording media. The sequence of the tracks stays as the original.

- 1 Insert a CD and, if desired, program track numbers.
- 2 Press EDIT to start the setup.
 - The display shows **EDIT** and *NORMAL*.
- 3 Press **PREV.** ◀◀ or **NEXT** ▶▶ (PREV. ◀ or NEXT ▶ on the remote control) to switch through the different scan modes.
 - *NORMAL*, *OPTIMAL*, *STOP*... (*STOP* aborts the edit function).
- 4 As soon as the desired edit mode is displayed press EDIT.
 - The display shows **C 90**. ➤

- 5 Press **PREV.** ◀◀ or **NEXT** ▶▶ (PREV. ◀ or NEXT ▶ on the remote control) to switch through the different recording times and media.
 - **C 100**, **C 120**, **CDR 21**, **CDR 60**, **CDR 74**, **C 30**, **C 45**, **C 60**, **C 90**...

Note: C is for cassette, CDR is for CD-Recordable and CD-Rewriteable and therefore for single-sided recording only.

- 6 As soon as the desired recording time and media is displayed press EDIT.
 - **A**, the number of tracks and the playing time are displayed.
- 7 Start your recording and press **PLAY** ▶ to start CD play.
 - If cassette (**C**) was selected the CD player pauses after playing the calculated tracks for side A. If CD-Recordable (**CDR**) was selected the CD player stops.
- 8 If required switch tape sides.
- 9 Press **PLAY** ▶ to start CD play again.
 - **B**, the number of tracks and the playing time are displayed. The remaining tracks for side B are played.

*Note: It is possible to switch between **A** and **B** by using **PREV.** ◀◀ or **NEXT** ▶▶ (PREV. ◀ or NEXT ▶ on the remote control).*

Environmental information

All redundant packing material has been omitted. We have done our utmost to make the packaging easily separable into three mono materials: cardboard (box), polystyrene foam (buffer) and polyethylene (bags, protective foam sheet).

Your set consists of materials which can be recycled if disassembled by a specialized company. Please observe the local regulations regarding the disposal of packing materials, exhausted batteries and old equipment.

TROUBLESHOOTING

English

WARNING

Under no circumstances should you try to repair the CD player yourself as this will invalidate the guarantee.

If a fault occurs, first check the points listed below before taking the set for repair.

If you are unable to solve a problem by following this checklist, consult your dealer or service center.

Problem	Possible cause	Solution
No power	Mains cable is not securely connected.	Connect mains cable properly.
No or bad sound	Volume is too low.	Adjust volume.
	Interference caused by electric equipment like TVs, computers, engines, etc.	Keep the CD player away from electrical equipment.
	Loose or wrong connections.	Connect the CD player correctly.
No or bad headphone sound	Volume is too low.	Adjust VOLUME -/+.
	Headphone plug is dirty.	Clean headphone plug.
No or low quality recording	Volume is too low.	Adjust VOLUME -/+.
	Loose or wrong connections.	Connect the CD player correctly.
No reaction to operation of any keys	Electrostatic discharge.	Disconnect the CD player from mains, reconnect after a few seconds.
INSERT DISC is displayed	No CD is inserted.	Insert a CD.
	The CD is badly scratched or dirty.	Replace or clean the CD.
	The CD is inserted upside down.	Insert CD with label upwards.
DISC NOT FINALIZED is displayed	The CD-RW (or CD-R) is not properly recorded for the use on a standard CD player.	Read the instruction booklet of your CD-Rewriteable (or CD-Recordable) recorder on how to finalize a recording.
	The CD is badly scratched or dirty.	Replace or clean the CD.
WRONG TRACK is displayed	Chosen track number is higher than the highest track number on the CD.	Key in a track number within the range of the track numbers on the CD.
0:00 is displayed	First track of the CD is longer than the first side of the chosen recording media.	Choose a recording media with a recording time longer than the first track of the CD.
VOLUME FIXED is displayed (CD 723 only)	Volume is locked.	Press EDIT for more than 2 seconds to unlock the volume.
Some CD-Text track information is not displayed	Too much information on the CD-Text disc.	Use a CD-Text disc with less information.
CD skips tracks	SHUFFLE or PROGRAM is active.	Switch off SHUFFLE or PROGRAM play.
	The CD is badly scratched or dirty.	Replace or clean the CD.
	Laser lens is dirty.	Clean with a commonly available cleaning CD.
	The laser lens is steamed up.	Wait until the lens has cleared.
Remote control does not function properly	Batteries are inserted incorrectly.	Insert batteries correctly.
	Batteries are flat.	Insert fresh batteries.
	Distance to the CD player is too large.	Reduce distance.

English

Français

Español

中文

Meet Philips at the Internet
<http://www.philips.com>

