

PHILIPS

CD 6660 CD Cassette Sound Mixer System

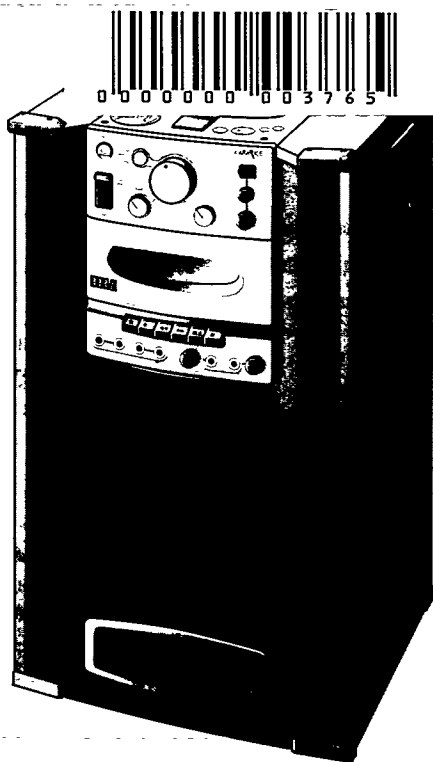

Instructions for use
Mode d'emploi
Instrucciones de manejo
Bedienungsanleitung
Gebruiksaanwijzing
Istruzioni per l'uso
Manual de utilização
Brugsanvisning
Bruksanvisning
Käyttöohje
Οδηγίες χρήσεως



PHILIPS

Important notes for users in the U.K.

Mains plug

This apparatus is fitted with an approved moulded 13 Amp plug. To change a fuse in this type of plug proceed as follows:

- Remove fuse cover and fuse
- Fix new fuse which should be a BS1362 5 Amp, A.S.T.A. or BSI approved type
- Refit the fuse cover

If the fitted plug is not suitable for your socket outlets, it should be cut off and an appropriate plug fitted in its place.

If the mains plug contains a fuse, this should have a value of 5 Amp. If a plug without a fuse is used, the fuse at the distribution board should not be greater than 5 Amp.

Note: The severed plug must be disposed to avoid a possible shock hazard should it be inserted into a 13 Amp socket elsewhere.

How to connect a plug

The wires in the mains lead are coloured with the following code: blue = neutral (N), brown = live (L). As these colours may not correspond with the colour markings identifying the terminals in your plug, proceed as follows:

- Connect the blue wire to the terminal marked N or coloured black
- Connect the brown wire to the terminal marked L or coloured red.
- Do not connect either wire to the earth terminal in the plug, marked E (or \perp) or coloured green (or green and yellow).

Before replacing the plug cover, make certain that the cord grip is clamped over the sheath of the lead - not simply over the two wires. Copyright in the U.K. Recording and playback of material may require consent. See Copyright Act 1956 and The Performer's Protection Acts 1958 to 1972.

N Norge

Advarsel: For å redusere faren for brann eller elektrisk støt, skal apparatet ikke utsettes for regn eller fuktighet.

Typeskilt finnes på apparatens bakside.

Observer: Nettbryteren er sekundært innkoplet. Den innebygde nettdelen er derfor ikke frakoplet nettet så lenge apparatet er tilsluttet nettkontakten.

**CLASS 1
LASER PRODUCT**

English 4

English

Français 16

Français

Español 29

Español

Deutsch 42

Deutsch

Nederlands 54

Nederlands

Italiano 66

Italiano

Português 78

Português

Dansk 90

Dansk

Svenska 102

Svenska

Suomi 114

Suomi

Ελληνικά 126

Ελληνικά

CONTROLS

TOP AND FRONT PANELS

See fig. 1

- ① **VOLUME** - to adjust the volume level.
- ② **DBB** - for an enhanced Dynamic Bass Boost.
- ③ **POWER** \odot - to switch the set on/off.
- ④ **Power indicator** - lights up when the set is switched on.
- ⑤ **CD/TAPE/LINE IN** - to select the sound source.
- ⑥ **REMOTE SENSOR** - infrared sensor for remote control.
- ⑦ **BASS** - for adjusting the bass (low) tones.
- ⑧ **TREBLE** - to adjust the treble (high) tones.
- ⑨ **Counter** to monitor and locate cassette tape passages.
COUNTER RESET - to reset the tape counter.
- ⑩ H - headphone socket.
- ⑪ **LINE OUT** - stereo output to an external amplifier, tape deck, etc.
- ⑫ **LINE IN** - stereo input for connection of an external source tape deck, CD player, etc.
- ⑬ **GUITAR IN** - input socket for an electric guitar, piano, synthesizer, etc.
- ⑭ **CD PLAYER:**
OPEN - to open/close the CD door.
STOP \blacksquare - to stop playback or erase a programme.
PLAY•PAUSE \blacktriangleright II - to start or interrupt CD play.
SEARCH \blacktriangleleft or \blacktriangleright - to search backwards and forwards within a track; to skip to the beginning of a current/previous or subsequent track.
SHUFFLE - to play CD tracks in random order.
PROGRAM - to programme tracks and to review the programme.
REPEAT - to repeat a track/CD programme/entire CD.
- ⑮ **Display** - to show the status of the CD player and any active KEY CHANGER adjustments.

- ⑯ **KARAOKE mode** - to select one of the following modes:
NORMAL - for normal playback of CDs and tapes.
CH 1/CH 2 - (for special karaoke CDs and tapes only) to select right or left channel playback: the original vocals or music can be completely omitted during playback.
VOCAL FADER - for suppressing the original vocals during playback on CD/TAPE/LINE IN modes.
- ⑰ **Handle**
- ⑱ **KEY CHANGER** - for changing the key of the music during playback on CD/TAPE/LINE IN modes.
- ⑲ **DIGITAL ECHO** - to adjust the microphone's echo effect.
- ⑳ **Cassette compartment**
- ㉑ **CASSETTE RECORDER keys:**
RECORD \bullet - to start recording.
PLAY \blacktriangleright - to start playback.
SEARCH:
REV/ \blacktriangleleft - to fast review/rewind the tape.
CUE/ \blacktriangleright - to cue/fast wind the tape.
STOP•OPEN \blacksquare \blacktriangle - to stop the tape and to open the cassette holder.
PAUSE II - to interrupt recording or playback.
- ㉒ **MIC 1 or 2 VOL** - to adjust the volume of the respective microphone.
- ㉓ **MIC 1 or 2** - microphone input.
- ㉔ **Bass port**

BACK PANEL

See fig. 2

- ① **Ext. DC** - 5.5 mm socket for 12 V car battery adapter.
- ② **AC MAINS** - socket for mains lead.
- ③ **Voltage Selector** - to select 120/230 V.

1

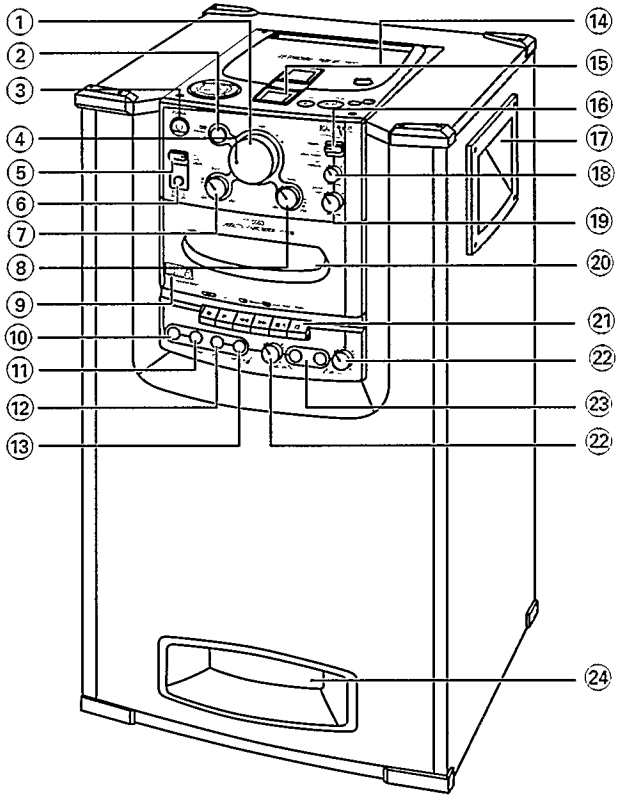

2

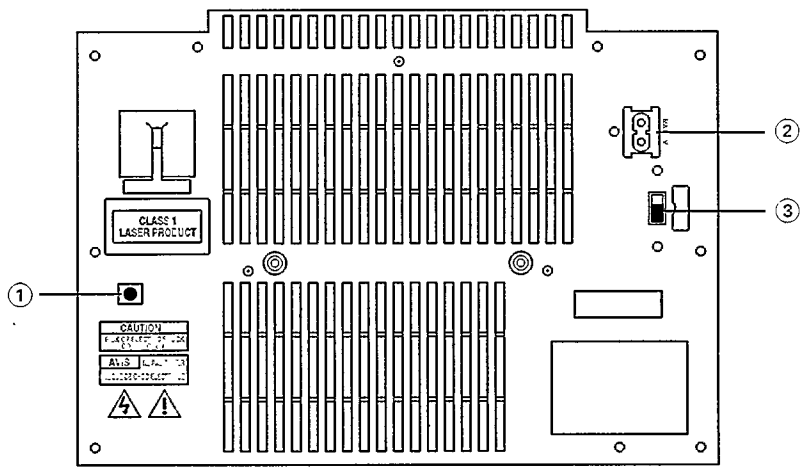

REMOTE CONTROL

- ① ► **II** - to start or interrupt CD playback.
- ② ◀ - To skip to a previous track/the beginning of a track.
▶ - To skip to a next track.
- ③ ■ - to stop playback or erase a CD programme.
- ④ **VOLUME ▲** - to increase the volume level.
VOLUME ▼ - to decrease the volume level.

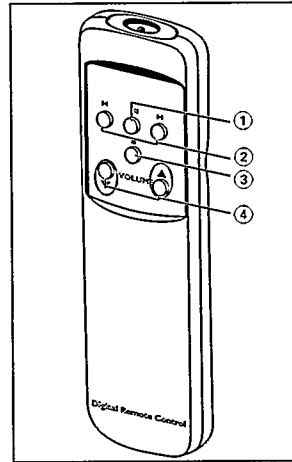

Remote control batteries (included)

1. Open the battery compartment and insert as shown two batteries, type AA, R06 or UM3 (preferably alkaline).
 2. Replace the compartment door, making sure the batteries are firmly and correctly in place. The set is now ready to operate.
- **Important!** Remove the batteries if exhausted or if they will not be used for a long period.
 - The incorrect use of batteries can cause electrolyte leakage and will corrode the compartment or cause the batteries to burst. Therefore:
 - Do not mix battery types, e.g. alkaline with zinc carbonate.
 - When inserting new batteries, replace both the (old) batteries in use at the same time.

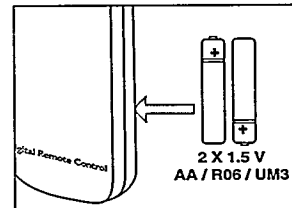

Batteries contain chemical substances, so they should be disposed of properly.

MAINS

1. Check if the mains voltage as shown on the type plate (on the back of the set) corresponds to your local mains voltage. If it does not, consult your dealer or service organisation.
2. If your set is equipped with a voltage selector, adjust the selector to match with your local mains supply.
3. Connect the mains lead to the MAINS socket and the wall socket.
→ The set is now ready to use.
4. To switch off the mains supply completely, pull the mains plug out of the wall socket.

For users in the U.K.: please follow the instructions on page 2.

Environmental Note: Save Energy.

Switching POWER on/off

Always release the **POWER** button to the off position when not using the set.

To avoid overheating of the set a safety circuit has been built in. Therefore your set may disconnect under extreme conditions. If this happens, switch off the set and let it cool down before further operation.

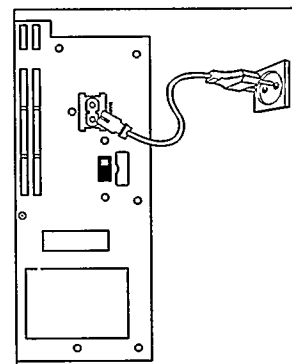

MAINS**AC Power consumption**

Set in **standby mode**: 6-7 Watts

Unplug your set from the wall socket overnight, or when not in use to save energy.

12 V Car Battery Use

A special car battery cable is required available from your dealer or service centre.

- Insert the cable into the Ext. DC socket at the back of the set first and then connect to the cigarette lighter socket.

(Only for a 12 V car battery with negative grounding.)

Environmental information

All redundant packaging material has been omitted. We have done our utmost to make the packaging easily separable into three mono materials: cardboard (box), expandable polystyrene (buffer) and polyethylene (bags, protective foam sheet).

Your set consists of materials which can be recycled if disassembled by a specialized company. Please observe the local regulations regarding the disposal of packaging materials, exhausted batteries and old equipment.

GENERAL OPERATION

1. To switch on the set, press the POWER button.
→ The power indicator of the set lights up.
2. Adjust the CD/TAPE/LINE IN selector to the desired position to select your sound source.
3. Adjust the sound using the VOLUME, TREBLE and the BASS or DBB controls.
4. If desired, you can also adjust the key of the CD/TAPE/LINE IN playback by using the KEY CHANGER.
5. To switch off the set, press the POWER button.
→ The power indicator on the set goes out

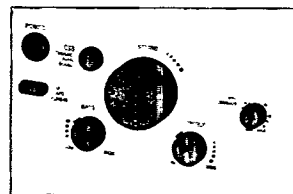
**BASS Control Notes:**

- The DBB and BASS controls are mutually exclusive functions. If the DBB function is activated, the BASS function is cancelled.
- The BASS level setting is automatically reduced if the volume is adjusted higher than half the maximum. This is a built-in safety mechanism to prevent distortion.

HEADPHONES

For headphones with a 6.35 mm socket.

- When headphones are inserted into the  socket, the speaker system is automatically disconnected.

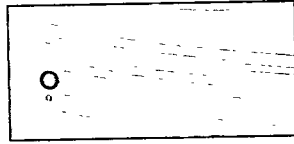

MICROPHONE CONNECTION (1 x Philips microphone supplied)

For microphones with a 6.35 mm socket. You can reproduce and also mix your voice with CD's, cassettes, a line in source or a guitar! You can also use two microphones for a karaoke duet or microphone mixing function.

1. Before you plug in the microphone, turn the respective MIC 1 or 2 VOL control to minimum volume to prevent acoustic howling.
2. Connect your microphone to the MIC 1 or 2 socket and switch on the microphone.
3. Adjust the microphone volume to your desired level with the respective MIC 1 or 2 VOL control.
4. If desired, adjust the ECHO control to create a resonance effect.
 - Set ECHO to the minimum level if you do not wish to apply the ECHO effect.

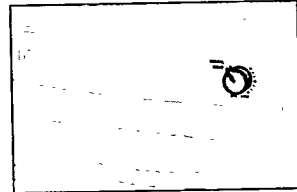
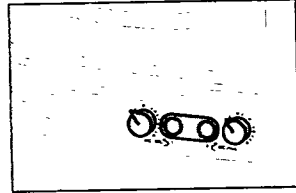

Note: When using the microphone, position it so that it is directed away from the speaker system to prevent acoustic howling.

LINE OUT

For amplifying or recording on an external source e.g. mini Hi-fi system, etc. A connection cord with a 6.35 mm jack may be required for the connection.

1. Connect the connection cord from the LINE OUT socket of the set to the LINE IN socket of the external source.
 - The connection cords should be fully inserted into the LINE OUT and LINE IN sockets of the respective sets.
2. To adjust the volume of your connected external source, use the volume control located on the external source.

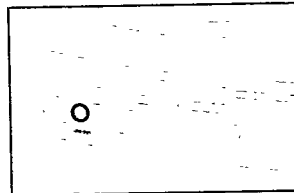

OPERATION

English

LINE IN

For amplifying or recording from an external CD player, amplifier, tuner, recorder, electric musical instruments, etc. A connection cord with a 6.35 mm jack may be required for the connection.

1. Connect the connection cord from the LINE IN socket of the set to the LINE OUT socket of the external source.
 - The connection cords should be fully inserted into the LINE IN and LINE OUT sockets of the respective sets.
2. Set the source selector to LINE IN on the Sound Mixer.
3. To adjust the sound of your connected external source, use the VOLUME, TREBLE, BASS or DBB controls located on the Sound Mixer.

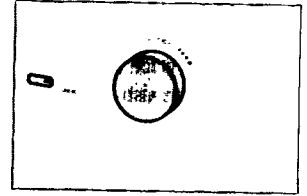
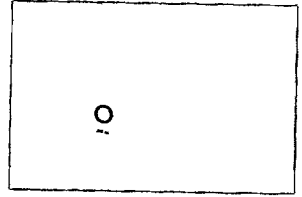

GUITAR IN

For amplifying or recording from an electric guitar or musical instrument. The GUITAR IN signal can also be mixed with the CD/TAPE/LINE IN sources. A 6.35 mm jack may be required for the GUITAR IN connection.

- Connect the connection cord from the musical instrument to the GUITAR IN socket of the set.
- Adjust the volume using the controls on the musical instrument.

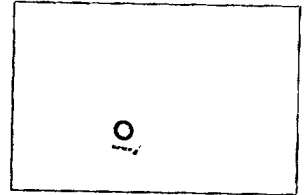

KARAOKE MODE FEATURES

CH 1 and CH 2

Special karaoke CDs and tapes are pre-recorded to enable two modes of playback: the vocal mode or the instrumental mode.

- Adjust the karaoke mode selector to either CH 1 or CH 2 to select the desired mode.

NORMAL

This allows you to listen to the original recording of Karaoke CDs/tapes without channel selection.

- Adjust the karaoke mode selector to NORMAL.

VOCAL FADER

This function suppresses the main vocals during playback and can be used in all three different source modes: CD, TAPE and LINE IN.

- Adjust the karaoke mode selector to VOCAL FADER.
 - The original vocals will now become faintly audible.

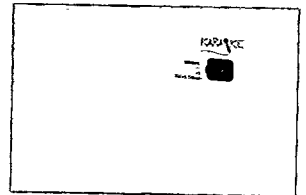

KARAOKE MODE FEATURES

KEY CHANGER

During playback of CDs, cassettes and LINE IN sources, you can use the KEY CHANGER to change the key of the music to suit your voice. The selected key information will be shown briefly in the display as a two digit number from 00-06.

- To adjust the key of the original singer and music to match your voice, turn the control clockwise from the centre position (00) for a range of six higher keys (01 - 06).
- Turn anti-clockwise if you want a lower key (01 - 06).
- If you do not wish to alter the original key, set the KEY CHANGER to the centre position.
 - In addition to the '00' display indication, a small click can be felt indicating the centre position when turning the control.

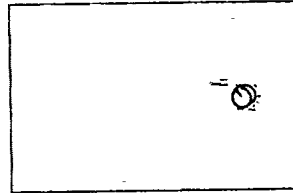

CD DISPLAY INDICATION

cd: When you select the CD mode/open the CD compartment.

no: when no disc inserted/ CD programme is erased/ error in CD operation or with the CD (see Troubleshooting)

Total track number: in stop mode or at the end of a CD programme/ playback.

▶ **and the current track number:** during playback.

▶ **II and the current track number:** CD functions and the display freezes in pause position.

SHUFFLE/REPEAT (ALL) modes: when the respective mode is activated

PROGRAM: when programme mode active.

P: when you store a track.

F: memory full, no further tracks can be programmed.

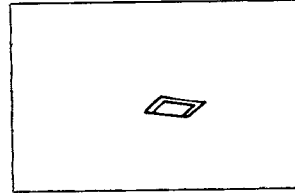

CD PLAYBACK

1. Adjust the CD/TAPE/LINE IN selector to CD position.
2. Press OPEN to open the CD player compartment
3. Insert the CD, printed side facing up and push down on the CD door to close.
4. Start playback by pressing PLAY•PAUSE ►II.
5. Adjust the sound using the VOLUME, TREBLE and the BASS or DBB controls.
6. To interrupt playback, press PLAY•PAUSE ►II. Press PLAY•PAUSE ►II again to continue playback.
7. Press STOP ■ to stop CD playback.
8. To switch off the set press the POWER button.

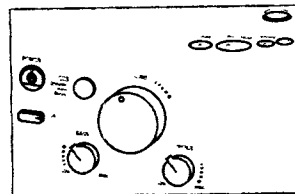

CD PLAYER

English

PLAYING A CD

Note: CD playback will also stop when:

- the CD door is opened;
- the CD has reached the end;
- you adjust the CD/TAPE/LINE IN selector to TAPE or LINE IN mode;
- you press the POWER button;
- an error has occurred.

SEARCH ◀◀ or ▶▶

Selecting a different track

- On the set, press SEARCH ◀◀ or ▶▶ once or repeatedly until the required track number appears in the display. Alternatively, on the remote control press ◀◀ or ▶▶ once or more to select the required track.
- If you have selected a track number shortly after loading a CD or in the PAUSE position, you will need to press PLAY • PAUSE ▶▶ to start playback.

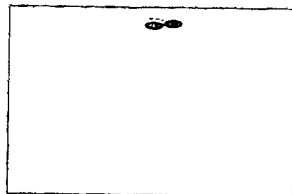

Searching for a passage within a track

1. On the set, press and hold down SEARCH ◀◀ or ▶▶.
→ The CD is played at high speed and low volume.
2. When you recognize the passage you want, release the SEARCH ◀◀ or ▶▶ controls.
→ Normal CD playback will resume at this point.

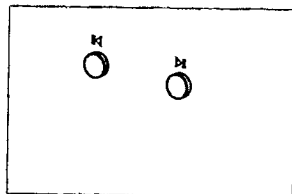

Different play modes: SHUFFLE/REPEAT

You can select and change the different play modes before or during playback.

→ The play modes can also be combined with PROGRAM **SHUFFLE** - Tracks of the entire CD or the programme are played in random order.

SHUFFLE REPEAT ALL - To repeat the entire CD or programme continuously in random order.

REPEAT ALL - Repeats the entire CD.

REPEAT (SHUFFLE REPEAT) - Plays the current (random) track continuously.

1. Press SHUFFLE/REPEAT before or during playback until the desired function appears on the display.
2. To leave the REPEAT/SHUFFLE mode, press the respective SHUFFLE or REPEAT button repeatedly until the various REPEAT/SHUFFLE modes are no longer shown on the display.
→ You can also press STOP ■ to quit playback.

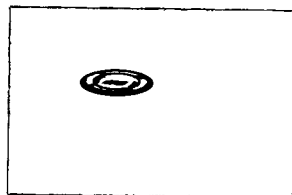

PROGRAMMING TRACK NUMBERS

Before or during playback, select and programme your CD tracks in the desired sequence. You can store any track more than once. Up to 20 tracks can be stored in the memory.

- When the programme memory is full, the display will show **F** and it will not be possible to add further tracks to your current programme.
1. Select the desired track using SEARCH ◀◀ or ▶▶ until the display shows the desired track number.
 2. Press PROGRAM to confirm the track number to be stored.
→ The display will briefly show **P**.
 3. Repeat steps 1 and 2 to select and store all desired tracks in this way.

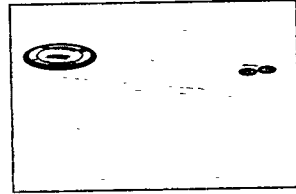

Reviewing your programme

- To review your set programme, keep PROGRAM pressed for 2 seconds and the display will show your stored track numbers in sequence.

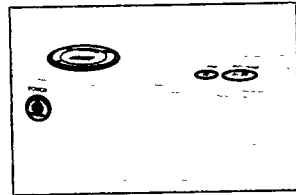

Playing your programme

- If you have programmed in the STOP position, press PLAY•PAUSE ▶ || to start playback.
- If you have programmed in the play mode, first press STOP ■ and then PLAY•PAUSE ▶ || to start playback.

Erasing a programme

You can erase a programme by:

- pressing STOP ■ twice;
- opening the CD door;
- pressing the POWER button;
- changing the sound source.

CASSETTE PLAYBACK

1. Adjust the CD/TAPE/LINE IN selector to TAPE position.
2. Press STOP•OPEN ■ ▲ to open the cassette holder.
3. Insert a recorded cassette and shut the cassette holder.
4. Press PLAY ▶ and playback will start.
5. Adjust the sound using the VOLUME, TREBLE and the BASS or DBB controls.
6. For brief interruptions, press PAUSE ||. Press PAUSE || again to resume playback.
7. During playback or fast winding, you can watch the 3 digit Counter to help you find and locate a desired passage.
 - Press the COUNTER RESET switch to reset the counter to 000.

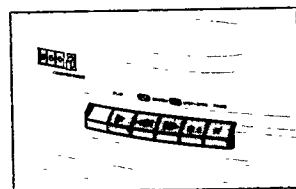
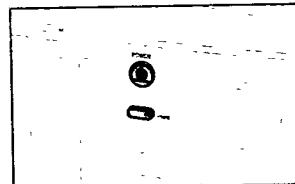

CASSETTE RECORDER

CASSETTE PLAYBACK

8. In the stop position, press SEARCH ◀◀ or ▶▶, to fast wind the tape in the respective direction.
 - To review/cue, during playback press and hold down on the respective ◀◀ SEARCH ▶▶ key to hear tape playback at high speed. Release your finger from the key to return to normal playback.
9. To stop fast winding or to stop the tape, press STOP•OPEN ■▲.
 - The keys are automatically released at the end of the tape.
 - Always make sure that the PLAY ▶ key is released when you are not using the cassette deck.
10. To switch off the set, release the POWER button.

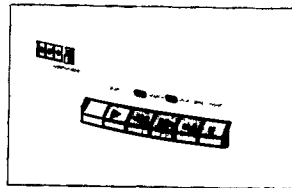

CASSETTE RECORDING

General information on cassette recording

- Recording is permissible insofar as copyright or other rights of third parties are not infringed.
- This deck is **not** suited for recording on METAL (IEC IV) type cassettes. For recording you should use NORMAL type cassettes (IEC I) or CHROME (IEC II) type cassettes on which the tabs have not been broken.
- The recording level is set automatically. Altering the VOLUME, BASS, TREBLE or DBB controls will not affect the recording in progress.
- No recording will take place during the first 7 seconds, when the leader tape passes the recorder heads.
- To prevent the accidental erasure of a recording, keep the cassette side to be safeguarded in front of you and break out the left tab. Recording on this side is no longer possible. To render this safeguard ineffective, cover the tabs with a piece of adhesive tape.
- If you do not wish to use the microphone, GUITAR IN, or LINE IN in your recording, disconnect these sources to avoid accidental mixing with the recording source.
- Do not press the SEARCH ◀◀ or ▶▶ keys during recording.

Basic recording operation

The following six steps apply to all source recordings.

1. Select your source of sound for recording (CD, TAPE, LINE IN).
2. Press STOP•OPEN ■▲ to open the cassette holder.
3. Insert a blank cassette into the cassette deck and shut the cassette holder.
4. Press RECORD ● to start recording.
5. For brief interruptions, press PAUSE II. To resume recording, press PAUSE II again.
6. To stop recording press STOP•OPEN ■▲.

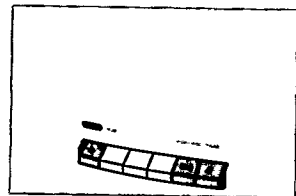

CASSETTE RECORDING

Sound Mixing, Microphone and Karaoke recording

For the musically ambitious you can play an electric guitar, a LINE IN source, sing along to a karaoke CD and if desired, use the KEY CHANGER and ECHO functions and record all this on tape.

1. Connect a microphone to the MIC 1 or 2 socket, as described under Microphone Connection.
2. Select your sound source for mixing (CD, TAPE, LINE IN).
3. Insert a blank cassette into the cassette deck and shut the cassette holder.
4. Press RECORD ● to start recording.
5. To stop recording press STOP•OPEN ■▲.

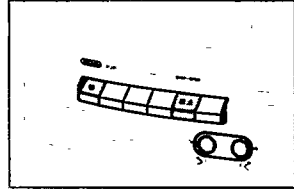

Synchro start CD recording

1. Adjust the CD/TAPE/LINE IN selector to CD position.
2. Insert a CD and if desired, programme track numbers.
3. Press STOP•OPEN ■▲ to open the cassette holder.
4. Insert a blank cassette into the cassette deck and shut the cassette holder.
5. Press RECORD ● to start recording.
→ Playing of the CD programme starts automatically from the beginning of the programme. It is not necessary to start the CD player separately.

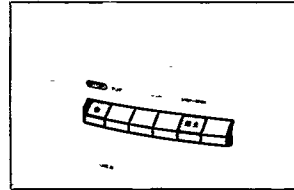

To select and record a particular passage within a track:

- a. press the SEARCH controls ◀◀ or ▶▶ on the CD player to find your passage
 - b. put the CD player on pause at the selected passage.
 - c. recording will begin from this exact point in the track when you press RECORD ●.
6. To stop recording press STOP•OPEN ■▲.

Recording from LINE IN sources

1. See the previous chapter on LINE IN to connect the LINE IN of the Sound Mixer with the LINE OUT of the external source.
2. Set the source selector to LINE IN.
3. Insert a blank cassette into the cassette deck and shut the cassette holder.
4. Press RECORD ● to start recording.
5. To stop recording press STOP•OPEN ■▲.

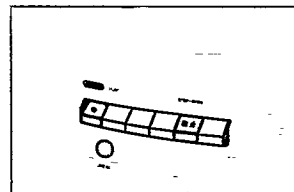

MAINTENANCE

English

PRECAUTIONS & GENERAL MAINTENANCE

- Place the set on a hard, flat surface so that it does not tilt.
- Do not expose the set, CDs, batteries or cassettes to humidity, rain, sand, direct sunlight or other places where high temperatures can occur, such as in the vicinity of heating apparatus or in motor cars parked in the sun.
- Do not cover the set. The set produces heat which must dissipate freely, so make sure that there is sufficient ventilation around the set. A minimum gap of 15 cm is necessary.
- The mechanical parts of the CD player and the cassette deck contain self-lubricating bearings and must not be oiled or lubricated.
- A chamois leather slightly moistened with water is sufficient for cleaning the housing. Do not use cleaning agents containing alcohol, spirits, ammonia or abrasives as these may harm the housing.
- The foam covering on the speaker is Velcro-fastened and fully detachable. To clean: detach the foam and gently wash in warm soapy water, or use a vacuum cleaner to remove dust.

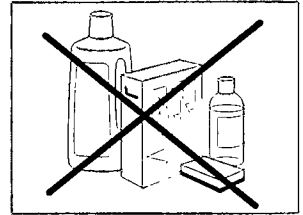
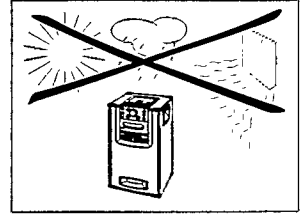

CD MAINTENANCE

- The lens of the CD player should *never be touched*.
- The lens may cloud over if the set is moved from cold to warm surroundings. The CD player will not start. Give the player some time to acclimatise.
- To take a CD out of its box, press the centre spindle while lifting the CD. Always pick up the CD by the edge and return the CD to its box after use to avoid scratching and dust.
- To clean the CD, wipe in a straight line from the centre towards the edge using a soft, lint-free cloth. Do not use cleaning agents as they may damage the disc.
- *Never write* on a CD or attach stickers to it.

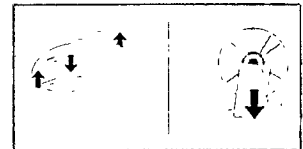

RECORDER MAINTENANCE

To ensure a good recording and playback quality, clean the indicated parts (A), (B) and (C) after every 50 hours of operation or, on average, once a month. Use a cotton bud slightly moistened with alcohol or a special head cleaning fluid.

- Open the cassette door by pressing STOP•OPEN ■▲.
- Press PLAY ► and clean the rubber pressure rollers (C).
- Then press PAUSE II and clean the capstans (B) and the heads (A).
- After cleaning, press STOP•OPEN ■.

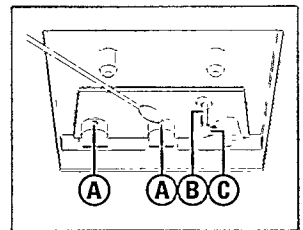

Note: Cleaning of the heads (A) can also be done by playing a cleaning cassette through once.

If a fault occurs, first check the points listed below before taking the set for repair. If you are unable to remedy a problem by following these hints, consult your dealer or service centre.

WARNING: Under no circumstances should you try to repair the set yourself, as this would invalidate the guarantee.

PROBLEM

– *POSSIBLE CAUSE*

• REMEDY

No sound/power

– *VOLUME is not adjusted.*

• Adjust the VOLUME.

– *Headphones are connected.*

• Disconnect headphones.

– *Mains lead is not securely connected.*

• Connect the mains lead properly.

– *Connection with car battery loose.*

• Check connection

CD playback does not work

– *CD is badly scratched or dirty.*

• Replace or clean the CD, see Maintenance.

– *Laser lens steamed up*

• Wait until lens has acclimatized

– *CD inserted upside down.*

• Insert CD the right way.

– *Wrong mode*

• Set the source selector CD/TAPE/LINE IN to CD

The CD skips tracks

– *CD is damaged or dirty.*

• Replace or clean the CD.

– *PROGRAM/SHUFFLE is active.*

• Switch off the PROGRAM/SHUFFLE function.

No reaction to operation of any controls/display does not function properly

– *Electrostatic discharge.*

• Disconnect the set from power supply, reconnect after a few seconds.

Poor cassette sound quality

– *Dust and dirt on the heads, capstan or pressure roller.*

• Clean the heads etc., see Maintenance.

– *Use of incompatible cassette type (METAL).*

• Only use NORMAL or CHROME for recording.

– *KEY CHANGER has been adjusted.*

• Return KEY CHANGER to centre (0) position.

– *VOCAL FADER active.*

• Adjust Karaoke Mode switch back to NORMAL.

Recording does not work

– *Cassette tab(s) may be broken out.*

• Apply a piece of adhesive tape over the missing tab space.

Remote control does not function properly

– *Batteries are exhausted.*

• Insert new batteries.

– *Batteries are incorrectly inserted.*

• Insert batteries correctly.

– *Distance or angle between the set is too large.*

• Reduce the distance or angle.

Howling noise when using microphone

– *Acoustic interference with speaker system.*

• Reduce MIC 1 or 2 VOL or direct microphone away from speaker system.

Microphone does not work

– *Microphone not switched on*

• Switch on microphone.

– *MIC VOL of corresponding MIC 1 or 2 not adjusted.*

• Turn up MIC VOL of corresponding MIC.

*This product complies with the radio interference requirements of the European Community
The type plate is located at the back of the set.*



CD6660 CD Cassette Sound Mixer System

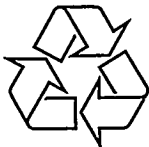

3140 115 24832

Meet Philips at the internet:
<http://www.philips.com>



TCtext/RR/0298