



Quick start guide

CD180

PHILIPS



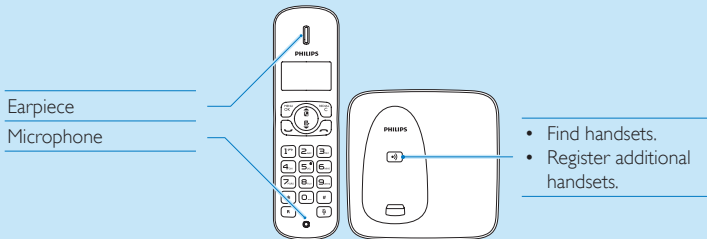

Important safety instructions

- Use only the power adapter listed in the technical data.
- Do not allow the product to come into contact with liquids.
- Risk of explosion if battery is replaced by an incorrect type.
- Dispose of used batteries according to the instructions. (Refer to the user manual online)

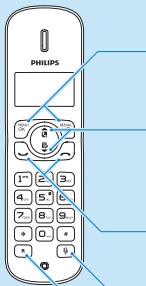
Overview







	In call	In idle mode	In menu
MENU/OK	Enter the option menu	Enter the option menu	Confirm selection
REDIAL/C	Enter the redial list	Enter the redial list	Cancel operation
	Increase the volume	Enter the phonebook	Scroll up
	Decrease the volume	Enter the call log	Scroll down
		Make and receive calls	
	End calls	Turn handset on/off (press and hold)	Exit menu/operation
	Mute/unmute the microphone		
R	Recall key* *network dependent		





 It displays the connection between the handset and the base. The more the bars are shown, the better the connection is.

 It indicates a received call in the call log.

 It indicates an outgoing call in the redial list.

 It flashes when there is a new missed call.
It remains steadily on when browsing the missed calls in call log.

 It flashes when receiving incoming call.
It remains steadily on during a call.

 The ringer is off.

 If you are using a voice mailbox from your provider, this icon flashes when there is a new message.
It remains steadily on when the voice messages are already viewed in the call log.
The icon is not shown when there is no voice message.
*This is network dependent

 It displays when you scroll up/down a list or increase and decrease the volume.

 There are more digits on the right.
Press **REDIAL/C** to read.

1 Connect

Connect the base station

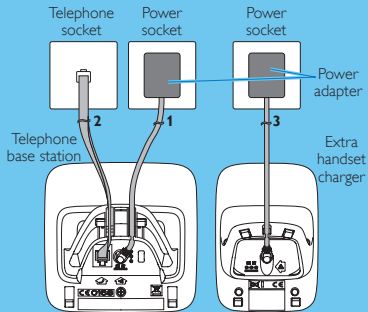

- 1 Connect each end of the power adapter to:
 - the DC input jack at the bottom of the base station;
 - the power socket on the wall.
- 2 Connect each end of the line cord to:
 - the telephone socket at the bottom of the base station;
 - the telephone socket on the wall.

For multi-handset version only:

- 3 Connect each end of the power adapter to:
 - the DC input jack at the bottom of the extra handset charger.
 - the power socket on the wall.

2 Get started

Configure your phone

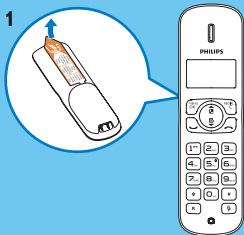

- 1 The batteries are pre-installed in the handset. Pull the battery tape off from the battery door before charging.
- 2 When using your phone for the first time, you see a welcome message (country dependent). After the welcome message, press **MENU/OK**.
- 3 Please set the country and language if prompted.
- 4 Set the date and time.
 - If the time is in 12-hour format, press  key to select **[AM]** or **[PM]**.

Charge your phone

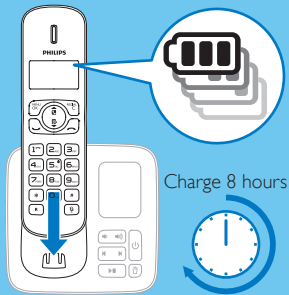

Place the handset on the base station to charge the handset. When the handset is placed correctly on the base station, you hear a docking sound.

↳ The handset starts charging.

Note Charge the batteries for 8 hours before first use.

Check the battery level



When the handset is off the base station/charger, the bars indicate the battery level (full, medium and low).





When the handset is on the base station/charger, the bars flash until charging completes.





The empty battery icon flashes and you hear an alert tone. The battery is low and needs recharging.

3 Enjoy

Call

- To make a call, press  and dial the phone number.
- To answer a call, press  when the phone rings.
- To end a call, press .

Earpiece volume



Press  or  to adjust the volume during a call.

Phonebook

Add record

- 1 Press **MENU/OK**, then select **[PHONEBOOK] > [ADD NEW]**, then press **MENU/OK** to confirm.
- 2 Enter the name, then press **MENU/OK** to confirm.
- 3 Enter the number, then press **MENU/OK** to confirm.

Call from the phonebook

- 1 Press  or, press **MENU/OK > [PHONEBOOK] > [VIEW]** to access the phonebook list.
- 2 Select a contact.
- 3 Press  to make the call.

Direct access memory

You have 2 direct access memories (Keys 1 and 2). To dial the saved phone number automatically, press and hold on the keys in idle mode.

Depending on your country, Keys 1 and 2 are preset to **[1_VOICEMAIL]** (voice mail number) and **[2_INFO SVC]** (information service number) of your network operator respectively (network dependent).

Call log

- 1 Press  and select a record.

To make a call

- 2 Press .

To view more details

- 2 Press **MENU/OK**.
- 3 Select **[VIEW]**.

To save a call record to the phonebook

- 2 Press **MENU/OK**.
- 3 Select **[SAVE NUMBER]**.
- 4 Press **MENU/OK** to confirm.
- 5 Enter the name.
- 6 Press **MENU/OK** to confirm.
- 7 Press **MENU/OK** to save.

To delete a call record

- 2 Press **MENU/OK**.
- 3 Select **[DELETE]** or **[DELETE ALL]**.
- 4 Press **MENU/OK** to confirm.

Redial list

- 1 Press **REDIAL/C** and select a record.

To make a call

- 2 Press .

To save a call record to the phonebook

- 2 Press **MENU/OK**.
- 3 Select **[SAVE NUMBER]**.
- 4 Press **MENU/OK** to confirm.
- 5 Enter the name.
- 6 Press **MENU/OK** to confirm.
- 7 Press **MENU/OK** to save.

To delete a call record

- 2 Press **MENU/OK**.
- 3 Select **[DELETE]** or **[DELETE ALL]**.
- 4 Press **MENU/OK** to confirm.

Register the handsets

You can register additional handsets to the base station. The base station can register up to 4 handsets.

- 1 Press **MENU/OK** on the handset.
- 2 Select **[SERVICES] > [REGISTER]**, then press **MENU/OK** to confirm.
- 3 Press and hold  on the base station for 5 seconds.
- 4 Enter the system PIN (0000).
- 5 Press **MENU/OK** to confirm the PIN.
↳ Registration is completed in less than 2 minutes.

Restore default settings

You can reset your phone settings to the original factory settings.

- 1 Press **MENU/OK**.
- 2 Select **[SERVICES]** > **[RESET]**, then press **MENU/OK** to confirm.
 - ↳ The handset displays a confirmation request.
- 3 Press **MENU/OK** to confirm.
 - ↳ All settings are reset
 - ↳ The welcome screen displays.

Technical data

Battery

- CORUN: 2 x AAA NiMH 1.2V Rechargeable 500mAh batteries
- SANIK: 2 x AAA NiMH 1.2V Rechargeable 500mAh batteries

Power adapter

Base and charger:

- Philips:
SSW-1920EU-2/SSW-1920UK-2/S003PV0600050/
S003PB0600050:
Input: 100-240V 50/60Hz 0.2A;
Output: 6V 500mA

Frequently asked questions

No signal bar displays on the screen.

- The handset is out of range. Move it closer to the base station.
- If the handset displays **[UNREGISTERED]**, register your handset (See the section on Register the handsets).

If I fail to register the additional handsets to the base station, what do I do?

Your base memory is full. Unregister the unused handsets and try again.

No dialing tone

- Check your phone connections.
- The handset is out of range. Move it closer to the base station.

I cannot change the settings of my voice mail, what do I do?

The voice mail service is managed by your service provider but not the phone itself. Contact your service provider to change the settings.

The handset on the charger does not charge.

- Ensure the batteries are inserted correctly.
- Ensure the handset is placed properly on the charger. The battery icon animates when charging.
- The charging contacts are dirty. Disconnect the power supply first and clean the contacts with a damp cloth.
- Batteries are defective. Purchase new ones from your dealer.

No display

- Ensure the batteries are charged.
- Ensure there are power and phone connections.

Bad audio (crackles, echo, etc.)

- The handset is nearly out of range. Move it closer to the base station.
- The phone receives interference from the nearby electrical appliances. Move the base station away from them.
- The phone is at a location with thick walls. Move the base away from them.

The handset does not ring.

Ensure the handset ringtone is turned on.

The caller ID does not display.

- The service is not activated. Check with your service provider.
- The caller's information is withheld or unavailable.

Welcome to Philips

Register your product at www.philips.com/welcome

Need help?

User manual / Online help

www.philips.com/support



Reproduction in whole or in part is prohibited without the written consent of the copyright owner.
Trademarks are the property of Koninklijke Philips Electronics N.V. or their respective owners.
© 2011 Koninklijke Philips Electronics N.V.
All rights reserved.



CE 0168

QSG_CD180_05_EN_V3.0
WK10464