

Quick Start Guide



Step A Setup

Step B Enjoy

What's in the Box?

You should find these items upon opening the box.

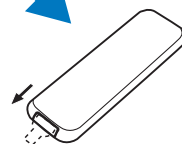
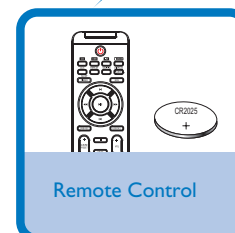
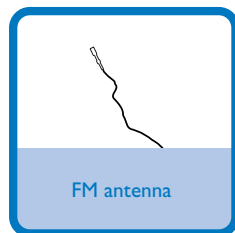
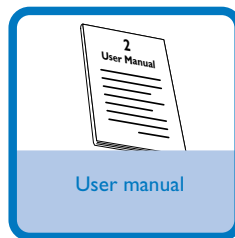
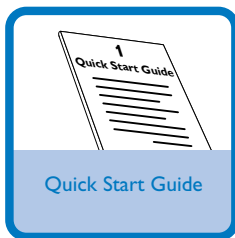

PHILIPS

Step A

Setup

Connection

- 1 For radio reception, connect the supplied FM antenna to the **FM ANTENNA** terminal.
- 2 Connect the speaker wires to the **SPEAKERS** terminals.
- 3 Connect the power cord of the system to the AC power outlet.

Tips:

- See the User Manual for how to connect other equipment to this system.
- Use the supplied AC power adaptor only! Using any other power connection device may damage your main set!

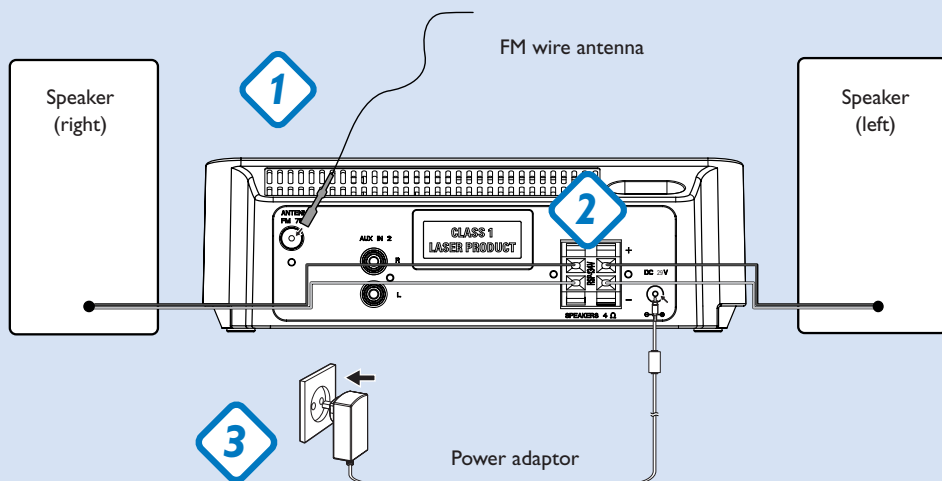

Setting the clock

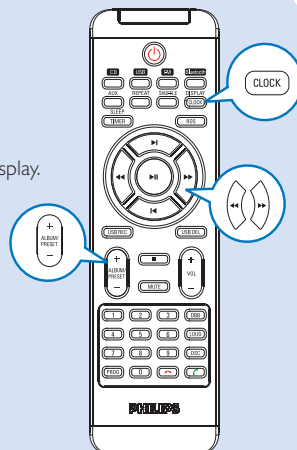

- 1 In standby mode, press **DISPLAY/CLOCK**.
- 2 Press **ALBUM/PRESET +/-** to select between 12 hour and 24 hour display.
- 3 Press **DISPLAY/CLOCK** again to confirm.
- 4 Press **ALBUM/PRESET +/-** to select the hour.
- 5 Press **DISPLAY/CLOCK** to confirm.
- 6 Repeat steps 4-5 to set minute.













Tip:

Refer to the user manual supplied for the description about compatibility of USB mass storage device, and playability of the files stored on the USB device.

Playing a USB mass storage device

- 1 Make sure that your BTM177 is being powered on.
- 2 Press **SOURCE** repeatedly (or **USB** on the remote) to enter USB mode. The LCD display shows USB.
- 3 Plug a compatible USB mass storage device to BTM177's USB port marked . If needed, use a suitable USB cable to connect between the device and BTM177's USB port. The device will automatically power on.
- 4 Press  on your BTM177 to start playback.
- 5 Press  to stop playback.

Operating a Bluetooth-enabled device via the system

- 1 Place a Bluetooth-enabled device for pairing within 10 meters from the system.
- 2 Press **SOURCE** on the top of the system (or **BLUETOOTH** on the remote control) to select the Bluetooth source.
- 3 Press and hold **PAIRING**  on the top of the system or the remote control for more than 3 seconds.
- 4 Set the Bluetooth-enabled device to search for other available Bluetooth devices until it recognizes "PHILIPS BTM177".
- 5 Select "PHILIPS BTM177" and wait until you hear a double beep from the system and the Bluetooth icon turns on.
 - Enter "0000" when prompted for a keyword.
- 6 For a paired HFP and/or HSP mobile phone, you can receive, reject or hold a call via the system with the **PAIRING** ,  and  buttons respectively.
 - For a paired A2DP device, you can enjoy music from it with the , , , ,  and  buttons via the system.

