

PHILIPS

Micro music system

BTB2670

User manual



Register your product and get support at
www.philips.com/support

Contents

1	Important	2
	Safety	2
	Notice	3

2	Your Micro Music System	5
	Introduction	5
	What's in the box	5
	Overview of the main unit	6
	Overview of the remote control	7

3	Get started	9
	Place your product	9
	Connect the radio antenna	9
	Connect power	9
	Prepare the remote control	10
	Power on	10
	Set the clock	10

4	Play	11
	Play from disc	11
	Play from USB	11
	Control play	12
	Skip tracks	12
	Program tracks	12
	Play from Bluetooth-enabled devices	13

5	Listen to the radio	14
	Listen to DAB+ radio	14
	Listen to FM radio	15

6	Adjust sound	17
	Select a preset sound effect	17
	Adjust volume level	17
	Mute sound	17

7	Other features	17
	Set the alarm timer	17
	Set the sleep timer	18
	Listen to an external device	18
	Charge your devices	18

8	Product information	19
	USB playability information	20
	Supported MP3 disc formats	20

9	Troubleshooting	21
----------	------------------------	-----------

1 Important

Safety

Read and understand all instructions before you use this micro music system. If damage is caused by failure to follow the instructions, the warranty does not apply.



This 'bolt of lightning' indicates uninsulated material within the device may cause an electrical shock. For the safety of everyone in your household, please do not remove the covering. The 'exclamation mark' calls attention to features for which you should read the enclosed literature closely to prevent operating and maintenance problems. **WARNING:** To reduce the risk of fire or electric shock, the device should not be exposed to rain or moisture and objects filled with liquids, such as vases, should not be placed on the device. **CAUTION:** To prevent electric shock, fully insert the plug. (For regions with polarized plugs: To prevent electric shock, match wide blade to wide slot.)

Warning

- Never remove the casing of this apparatus.
 - Never lubricate any part of this apparatus.
 - Never look into the laser beam inside this apparatus.
 - Never place this apparatus on other electrical equipment.
 - Keep this apparatus away from direct sunlight, naked flames or heat.
 - Ensure that you always have easy access to the power cord, plug or adaptor to disconnect the apparatus from the power.
-
- Make sure that there is enough free space around the product for ventilation.
 - Only use attachments/accessories specified by the manufacturer.
 - Battery usage **CAUTION** – To prevent battery leakage which may result in bodily injury, property damage, or damage to the product:
 - Install the battery correctly, + and - as marked on the product.
 - The battery (packed or installed) shall not be exposed to excessive heat such as sunshine, fire or the like.
 - Remove the battery when the product is not used for a long time.
 - The product shall not be exposed to dripping or splashing.
 - Do not place any source of danger on the product (e.g. liquid filled objects, lit candles).
 - Where the MAINS plug or an appliance coupler is used as the disconnect device, the disconnect device shall remain readily operable.

Hearing safety

Caution

- To avoid hearing damage, limit the time you use the headphones at high volume and set the volume to a safe level. The louder the volume, the shorter is the safe listening time.

Be sure to observe the following guidelines when using your headphones.

- Listen at reasonable volumes for reasonable periods of time.
- Be careful not to adjust the volume as your hearing adapts.
- Do not turn up the volume so high that you can't hear what's around you.
- You should use caution or temporarily discontinue use in potentially hazardous situations.
- Excessive sound pressure from earphones and headphones can cause hearing loss.

Notice

Any changes or modifications made to this device that are not expressly approved by Gibson Innovations may void the user's authority to operate the equipment.

Compliance

Hereby, Gibson Innovations declares that this product is in compliance with the essential requirements and other relevant provisions of Directive 2014/53/EU. You can find the Declaration of Conformity on www.philips.com/support.

Care of the environment

Disposal of your old product and battery



Your product is designed and manufactured with high quality materials and components, which can be recycled and reused.



This symbol on a product means that the product is covered by European Directive 2012/19/EU.



This symbol means that the product contains batteries covered by European Directive 2013/56/EU which cannot be disposed of with normal household waste.

Inform yourself about the local separate collection system for electrical and electronic products and batteries. Follow local rules and never dispose of the product and batteries with normal household waste. Correct disposal of old products and batteries helps prevent negative consequences for the environment and human health.

Removing the disposable batteries

To remove the disposable batteries, see battery installation section.

Environmental information

All unnecessary packaging has been omitted. We have tried to make the packaging easy to separate into three materials: cardboard (box), polystyrene foam (buffer) and polyethylene (bags, protective foam sheet.)

Your system consists of materials which can be recycled and reused if disassembled by a specialized company. Please observe the local regulations regarding the disposal of packaging materials, exhausted batteries and old equipment.



The Bluetooth® word mark and logos are registered trademarks owned by Bluetooth SIG, Inc. and any use of such marks by Gibson Innovations is under license.



The making of unauthorized copies of copy-protected material, including computer programs, files, broadcasts and sound recordings, may be an infringement of copyrights and constitute a criminal offence. This equipment should not be used for such purposes.

Care for your product

- Do not insert any objects other than discs into the disc compartment.
- Do not insert warped or cracked discs into the disc compartment.
- Remove the discs from the disc compartment if you are not using the product for an extended period of time.
- Only use microfiber cloth to clean the product.

This apparatus includes this label:



Note

- The type plate is located on the back of the product.

2 Your Micro Music System

Congratulations on your purchase, and welcome to Philips! To fully benefit from the support that Philips offers, register your product at www.philips.com/support.

Introduction

With this unit, you can:

- enjoy audio from discs, USB devices, Bluetooth devices, and other external devices;
- listen to FM and Digital Audio Broadcasting+ (DAB+) radio

The unit supports these media formats:









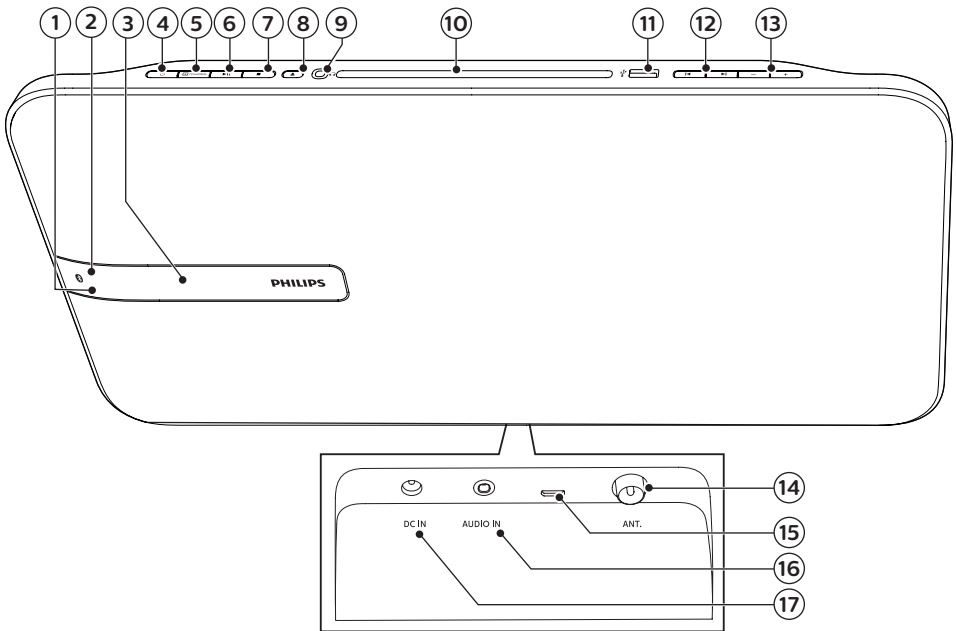

What's in the box

Check and identify the contents of your package:

- Main unit
- Table stand
- 1 x AC power adapter
- 1 x radio antenna
- Remote control (with one AAA battery)
- Printed materials

Overview of the main unit



- ① IR sensor
- ② LED indicator
 - Standby indicator: turns red when this product is switched to standby.
 - Bluetooth indicator: turns blue to indicate the Bluetooth connection status.
- ③ Display panel
 - Show current status.
- ④ 
 - Switch this product on or to standby.
- ⑤  /PAIRING
 - Press to select a source: DISC, USB, FM, DAB+, AUDIO IN, BT.
 - In Bluetooth mode, press and hold for more than 2 seconds to enter pairing mode.
- ⑥ 
 - Start or pause play.
- ⑦ 
 - Stop play.
 - Erase a program.
- ⑧ 
 - Eject a disc.
- ⑨ 
 - Headphone socket.
- ⑩ Disc slot
- ⑪ 
 - Connect USB storage devices for media play.
- ⑫ 
 - Skip to previous/next track.
 - Search within a track/disc.
 - Tune to a radio station.
 - Adjust time.

- Select a DAB+ station.

⑬ +/- (volume)

- Adjust volume.

⑭ ANT.

- Connect to the supplied radio antenna.

⑮ Micro USB socket for DAB upgrade (for use by the service center only)

⑯ AUDIO IN

- Connect external audio devices.

⑰ DC IN jack

- Connect to the supplied power adapter.

Overview of the remote control

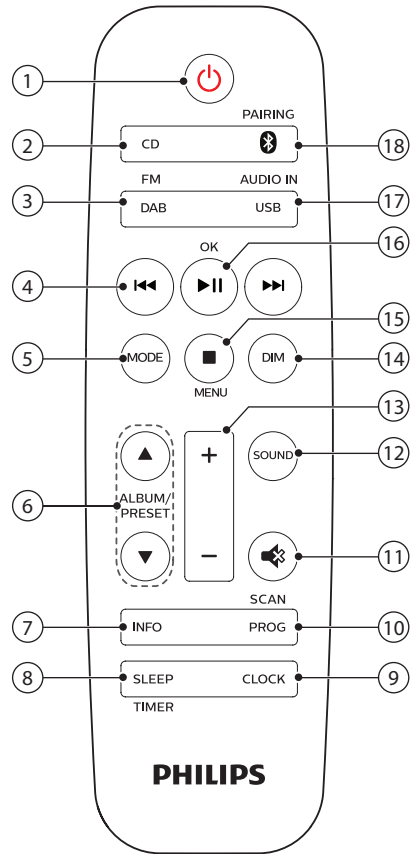

① ⏻

- Switch this product on or to standby.

② CD

- Select CD source.

③ DAB/FM

- Select FM or DAB+ source.

④ ⏮/⏭

- Skip to the previous/next track.
- Search within a track/disc/USB.

- Tune to an FM station.
 - Adjust time.
 - Select a DAB+ station.
- ⑤ **MODE**
- Select shuffle mode to play tracks randomly.
 - Select repeat mode to play a track or all tracks repeatedly.
- ⑥ **ALBUM/PRESET ▲ / ▼**
- Select a preset radio station.
 - Skip to previous/next album.
- ⑦ **INFO**
- Display playback information, or radio service information.
- ⑧ **SLEEP/TIMER**
- Set sleep timer.
 - Set alarm timer.
- ⑨ **CLOCK**
- Set the clock.
 - View clock information.
 - In standby, press and hold to toggle clock display on or off.
- ⑩ **PROG/SCAN**
- Program tracks.
 - Program radio stations.
 - Auto store radio stations.
- ⑪  **MUTE**
- Mute or restore volume.
- ⑫ **SOUND**
- Select a preset sound effect.
- ⑬ **+/- (volume)**
- Adjust volume.
- ⑭ **DIM**
- Adjust display brightness.
- ⑮ **■/MENU**
- Stop play or erase a program.
 - Enter or exit DAB+ menu.
- ⑯ **▶||/OK**
- Press to start, pause, or resume play.
 - Confirm or select a DAB+ item.
- ⑰ **USB/AUDIO IN**
- Select USB source.
 - Select AUDIO IN source.
- ⑱ **📶/PAIRING**
- Select Bluetooth source
 - In Bluetooth mode, press and hold for more than 2 seconds to enter pairing mode.

3 Get started

! Caution

- Use of controls or adjustments or performance of procedures other than herein may result in hazardous radiation exposure or other unsafe operation.

Always follow the instructions in this chapter in sequence.

Place your product

Before you place this product on the table, attach the supplied table stand to the main unit, as illustrated below.

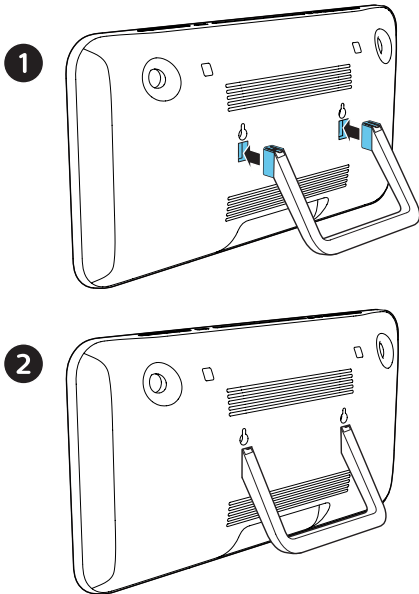

* Tip

- See the attached wall mounting sheet for how to mount this product onto wall.

Connect the radio antenna

Connect the supplied radio antenna to this product before listening to radio.

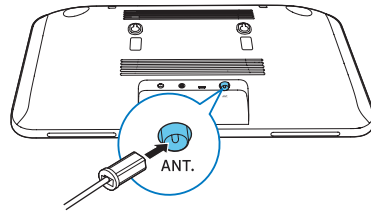

Connect power

! Caution

- Risk of product damage! Ensure that the power supply voltage corresponds to the voltage printed on the back or the underside of the unit.
- Risk of electric shock! Before you plug the AC power adaptor, make sure that the adaptor plug converter is fixed securely. When you unplug the AC power adaptor, always pull the plug, never the cord.
- Before you connect the AC power adaptor, make sure that you have completed all the other connections.

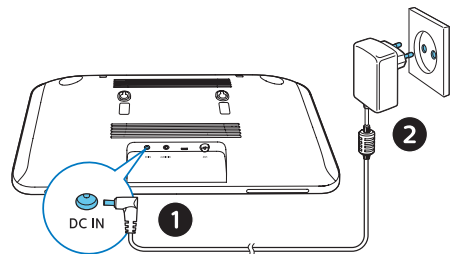

Connect the power cable to the wall socket.

Prepare the remote control

! Caution

- Risk of product damage! When the remote control is not used for long periods, remove the batteries.
- Batteries contain chemical substances, so they should be disposed of properly.

To insert the remote control battery:

- 1 Open the battery compartment.
- 2 Insert the supplied AAA battery with correct polarity (+/-) as indicated.
- 3 Close the battery compartment.

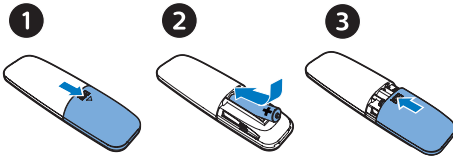

Power on

Press ϕ .

- ↳ The product switches to the last selected source.

Switch to standby mode

Press ϕ again to switch the product to standby with no clock display, or to standby with clock display.

- ↳ The red standby indicator lights up.
- In standby, you may press and hold **CLOCK** to toggle clock display on or off.

≡ Note

- The product switches to standby mode after 15 minutes inactive.
- To achieve the efficient energy saving performance, unplug any external electronic device from the USB port when the device is not in use.

Set the clock

- 1 In power on mode, press and hold **CLOCK** for more than 2 seconds to enter the clock setting mode.
↳ [24H] or [12H] is displayed.
- 2 Press \lll / \ggg to select 24H or 12H hour format, and then press **CLOCK**.
↳ The hour digits begin to blink.
- 3 Press \lll / \ggg to set the hour, and then press **CLOCK**.
↳ The minute digits begin to blink.
- 4 Press \lll / \ggg to set the minute, and then press **CLOCK**.
↳ The clock is set.



Note

- To view clock in power on mode, press briefly **CLOCK**.
- In standby, you may press and hold **CLOCK** to toggle clock display on or off.
- If clock display is turned on in standby, power consumption increases.

4 Play

Play from disc

- 1 Press **CD** to select CD source.
- 2 Insert a disc.
 - ↳ Play starts automatically. If not, press **▶||**.

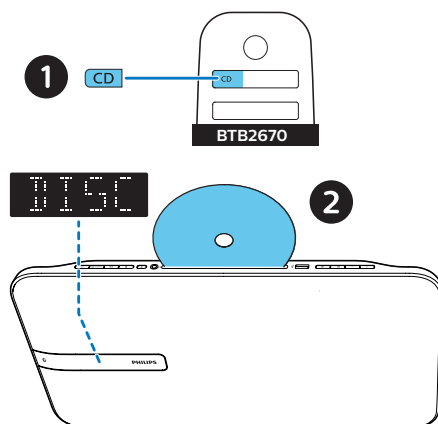

Play from USB



Note

- Make sure that the USB device contains playable audio content.

- 1 Insert a USB device into the  socket.
- 2 Press **USB** to select the USB source.
 - ↳ Play starts automatically. If not, press **▶||**.

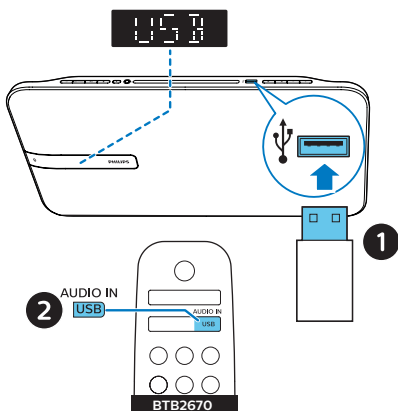

Skip tracks

For CD:

Press ◀◀ / ▶▶ to select tracks.

For MP3 disc and USB:

- 1 Press ▲ / ▼ to select an album or a folder.
- 2 Press ◀◀ / ▶▶ to select a track or a file.

Program tracks

This function allows you to program 20 tracks in the desired sequence.

- 1 In stop mode, press **PROG/SCAN** to activate the program mode.
↳ [P01] is displayed.
- 2 For MP3 tracks, press ▲ / ▼ to select an album.
- 3 Press ◀◀ / ▶▶ to select a track, and then press **PROG/SCAN** to confirm.
- 4 Repeat steps 2 to 3 to program more tracks.
- 5 Press ▶▶ to play the programmed tracks.

To erase the program

Press ■ twice.

Control play

▶|| Start, pause, or resume play.

■ Stop play.

▲ / ▼ Select an album or a folder.

◀◀ / ▶▶ Press to skip to the previous or next track.
Press and hold to search backward/forward within a track.

MODE Play a track or all tracks repeatedly.
Play tracks randomly.

+/- Increase or decrease the volume.

🔊 Mute or unmute sound.

SOUND Select a preset sound equalizer.

DIM Adjust display brightness.

INFO Show playback information.

Play from Bluetooth-enabled devices

Note

- Compatibility with all Bluetooth devices is not guaranteed.
- Any obstacle between the unit and the device can reduce the operational range.
- The effective operation range between this unit and your Bluetooth enabled device is approximately 10 meters (30 feet).
- The unit can memorize up to 8 previously connected Bluetooth devices.

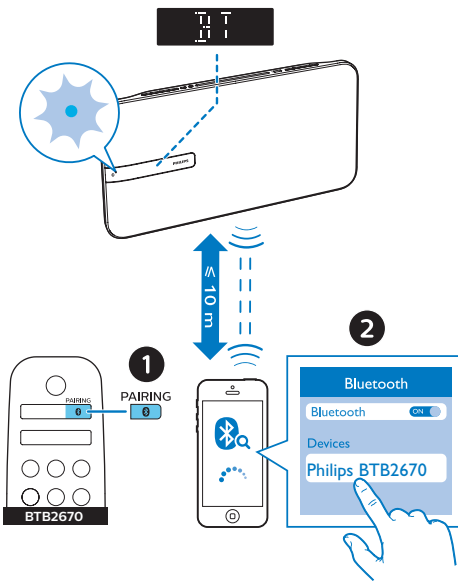

- 1 Press **0** to select the Bluetooth source.
 - ↳ [BT] (Bluetooth) is displayed.
 - ↳ The Bluetooth indicator flashes blue.
- 2 On your device that supports Advanced Audio Distribution Profile (A2DP), enable Bluetooth and search for Bluetooth devices that can be paired (refer to the user manual of the device).

- 3 Select “**Philips BTB2670**” on your Bluetooth enabled device and if necessary input ‘0000’ as the pairing password.
 - If you fail to search for “**Philips BTB2670**” or cannot pair with this product, press and hold **PAIRING** for more than 2 seconds to enter pairing mode.
 - ↳ After successful pairing and connection, the Bluetooth indicator turns solid blue, and the unit beeps twice.

- 4 Play audio on the connected device.
 - ↳ Audio streams from your Bluetooth enabled device to this product.

To disconnect the Bluetooth-enabled device:

- Deactivate Bluetooth on your device.

Pair and connect a second device

You can pair and connect a maximum of two Bluetooth-enabled devices to this product actively at the same time.

- 1 In Bluetooth mode, press and hold **PAIRING** for more than 2 seconds to enter pairing mode.
 - ↳ The Bluetooth indicator flashes blue quickly.
- 2 Connect a second Bluetooth device to this product.
 - ↳ The first connected device also stays connected to this product.
 - To play from the second connected device, stop music play from the first device, and then play music from the second device.

To connect and play from the third Bluetooth-enabled device

- Press and hold **PAIRING** for more than 2 seconds to enter pairing mode.
 - ↳ The first connected device or the device with no music playback is disconnected.

5 Listen to the radio

With this product, you can listen to DAB + radio and FM radio.

Note

- Position the antenna as far as possible from TV, or other radiation source.
- For optimal reception, fully extend and adjust the position of the antenna.

Listen to DAB+ radio

Digital Audio Broadcasting+ (DAB+) is a way of broadcasting radio digitally through a network of transmitters. It provides you with more choice, better sound quality and more information.

Store DAB+ radio stations automatically

Note

- New stations and services are added in DAB+ broadcast from time to time. To make new DAB+ stations and services available, perform scan regularly.

- 1 Press **DAB/FM** repeatedly to select DAB+ source.
 - If you enter DAB+ source for the first time or no DAB+ service is stored, [**Press OK to SCAN**] is prompted, then press **▶||/OK** to trigger scan, and skip step 2 below.

- 2 Press and hold **PROG/SCAN** for more than 2 seconds.
 - ↳ The product scans and stores all DAB+ radio stations automatically.
 - ↳ After scan, the first available station is broadcast.

Select a DAB+ radio station

After DAB+ radio stations are scanned and stored, press **◀◀/▶▶** to select a DAB+ station.

Store DAB+ radio stations manually

- 1 Press **◀◀/▶▶** to select a DAB+ radio station.
- 2 Press **PROG/SCAN** to activate program mode.
 - ↳ **[P01]** is displayed.
- 3 Press **▲/▼** to allocate a number from 1–20 to this radio station, and then press **PROG/SCAN** to confirm.
- 4 Repeat steps 1-3 to program more stations.

To select a preset DAB+ radio station:
In DAB+ mode, press **▲/▼**.

Use DAB+ menu

- 1 In DAB+ mode, press **■/MENU** to access DAB+ menu.
- 2 Press **◀◀/▶▶** to toggle the menu options.
 - **[SCAN]** (scan): Scan and store all available DAB+ radio stations.
 - **[MANUAL]** (manual): Tune to a DAB+ station manually.
 - **[PRUNE]** (prune): Remove invalid stations from the station list.
 - **[SYSTEM]** (system): Adjust system settings.

- 3 To select an option, press **▶II/OK**.
- 4 If a sub-option is available, repeat steps 2-3.
 - To exit the menu, press **■/MENU** again.

Under **[SYSTEM]** (system) menu

- **[RESET]** (reset): reset all settings to factory default.
- **[SW VER]** (software version): show the software version of this product.

Display DAB+ information

While listening to DAB+ radio, press **INFO** repeatedly to display various information (if available), such as frequency, signal strength, time, etc.

Listen to FM radio

Tune to an FM radio station

- 1 Press **DAB/FM** repeatedly to select FM source.
- 2 Press and hold **◀◀/▶▶** for more than 2 seconds.
 - ↳ The radio tunes to a station with strong reception automatically.
- 3 Repeat step 2 to tune to more stations.

To tune to a weak station:
Press **◀◀/▶▶** repeatedly until you find optimal reception.

Store FM radio stations automatically

Note

- You can store a maximum of 20 FM radio stations.

- 1 Press **DAB/FM** repeatedly to select FM source.
- 2 Press and hold **PROG/SCAN** for more than 2 seconds.
 - ↳ All available stations are programmed in the order of waveband reception strength.
 - ↳ The first programmed radio station is broadcast automatically.

Store FM radio stations manually

- 1 Tune to an FM radio station.
- 2 Press **PROG/SCAN** to activate program mode.
 - ↳ [P01] is displayed.
- 3 Press **▲/▼** to allocate a number from 1–20 to this radio station, and then press **PROG/SCAN** to confirm.
- 4 Repeat steps 1–3 to program more stations.

Note

- To overwrite a programmed station, store another station in its place.

Select a preset FM radio station

In FM mode, press **▲/▼** to select a preset number.

- While listening to FM radio, you may press **OK** to toggle stereo and mono sound.

Display RDS information

RDS (Radio Data System) is a service that allows FM stations to show additional information.

- 1 Tune to an FM radio station.
- 2 Press **INFO** repeatedly to display various RDS information (if available), such as station name, program type, time, etc.

6 Adjust sound

The following operations are applicable to all supported media.

Select a preset sound effect

- Press **SOUND** repeatedly to select a preset sound effect.

Adjust volume level

- On the remote control, press +/- (volume) repeatedly.

Mute sound

- Press  to mute or unmute the sound.

7 Other features

Set the alarm timer

This product can be used as an alarm clock. You can select the disc, radio, or .mp3 files on a USB storage device as alarm source.



Note

- Alarm timer is not available in AUDIO IN mode.
- If CD/USB source is selected, but no disc is placed or no USB device is connected, the radio source is selected automatically.

- 1 Make sure that you have set the clock.
- 2 In standby, press and hold **SLEEP/TIMER** for more than 2 seconds.
↳ The hour digits blink.
- 3 Press **⏪ / ⏩** repeatedly to set the hour, and then press **SLEEP/TIMER** to confirm.
↳ The minute digits blink.
- 4 Press **⏪ / ⏩** to set the minute, and then press **SLEEP/TIMER** to confirm.
↳ The last selected alarm source blinks.
- 5 Press **⏪ / ⏩** to select an alarm source (disc, USB, FM or DAB+ radio), and then press **SLEEP/TIMER** to confirm.
↳ **XX** blinks (XX indicates the volume level of alarm).
- 6 Press **⏪ / ⏩** to set the alarm volume, and then press **SLEEP/TIMER** to confirm.

Activate/deactivate alarm timer

In standby mode, press **SLEEP/TIMER** repeatedly to activate or deactivate timer.

- ↳ If timer is activated, **TIMER** is displayed.
- In standby, you may press and hold **CLOCK** to toggle clock display on or off.

Set the sleep timer

This music system can switch to standby automatically after a set period of time.

- When the music system is turned on, press **SLEEP/TIMER** repeatedly to select a set period of time (in minutes).
 - ↳ When sleep timer is activated, **SLEEP** is displayed.

To deactivate sleep timer

- Press **SLEEP/TIMER** repeatedly until **[OFF]** (sleep off) is displayed.
 - ↳ When sleep timer is deactivated, **SLEEP** disappears.

Listen to an external device

You can listen to an external device through this unit with an MP3 link cable.

- 1 Connect an MP3 link cable (not supplied) between:
 - **AUDIO IN** jack (3.5 mm) on the product,
 - and the headphone jack on an external device.
- 2 Press **AUDIO IN** repeatedly to select **AUDIO IN** source.

- 3 Start to play the device (see the device user manual).

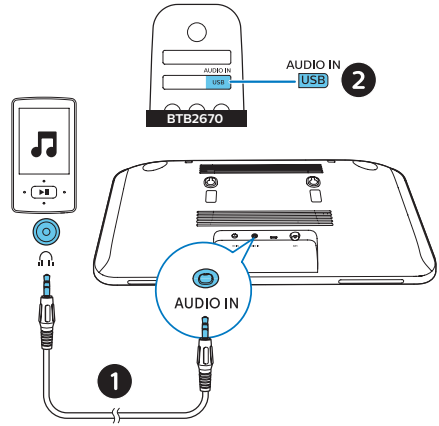

Charge your devices

With this micro music system, you can charge your external devices, such as your cell phone, MP3 player or other mobile devices.

- 1 Use a USB cable to connect the USB socket of this product with the USB socket of your devices.

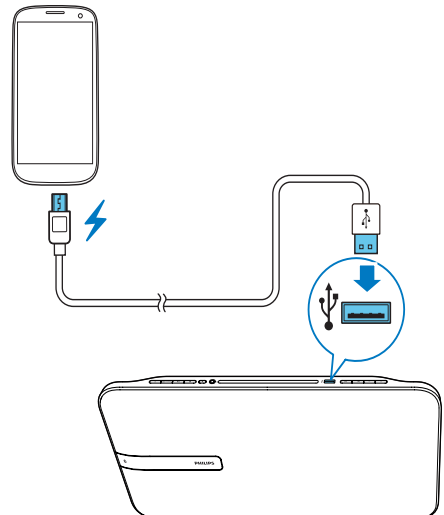

- 2 Connect the product to power.
↳ Once the device is recognized, the charging starts.



Note

- Compatibility of this product with all devices is not guaranteed.

8 Product information



Note

- Product information is subject to change without prior notice.
- **Rated output power (Amplifier):**
Total 20W (max.)
- **Acoustic frequency response:**
63Hz - 20kHz
- **Speaker driver:** 2 x 2.75" full range, 6Ω
- **Bass enhancement:** 2 x bass port
- **Support disc type:** CD, CD-R, CD-RW, MP3-CD (12 cm)
- **Bluetooth version:** V4.1 + EDR
- **Bluetooth supported profiles:** A2DP V1.2, AVRCP V1.4
- **Bluetooth frequency band / Output power:** 2.402GHz ~ 2.480GHz ISM Band / ≤ 4dBm (Class 2)
- **USB playback:**
 - Type A, USB Direct 2.0, 5V / 600mA, MSC file format, FAT 16/32
 - MP3, 32-320 Kbps and Variable bit rate
- **USB charging:**
2A max (Standby); 500mA max (USB/CD source); 1A max (BT/Radio/Audio in source)
** Actual charging current depends on the mobile devices.*
- **Tuner frequency range:** FM 87.5 - 108MHz; DAB 170MHz - 240MHz
- **Preset stations:** 20
- **AUDIO IN input level:**
600mV ±100mV RMS
- **Headphone:** 3.5mm jack

- **Power:**
 - Model (Philips branded AC power adapter): AS360-120-AE250
 - Input: 100-240 V~, 50/60 Hz, 1.2A
 - Output: DC 12.0V, 2.5A
- **Operation power consumption:** 15W
- **Standby power consumption:** < 0.5W (clock display off)
- **Dimensions (W x H x D):** 433 x 226 x 67 mm (without stand)
- **Weight:** 2.2 kg

USB playability information

Compatible USB devices:

- USB flash memory (USB2.0 or USB1.1)
- USB flash players (USB2.0 or USB1.1)
- memory cards (requires an additional card reader to work with this unit)

Supported USB formats:

- USB or memory file format: FAT12, FAT16, FAT32 (sector size: 512 bytes)
- MP3 bit rate (data rate): 32-320 Kbps and variable bit rate
- Directory nesting up to a maximum of 8 levels
- Number of albums/ folders: maximum 99
- Number of tracks/titles: maximum 999
- File name in Unicode UTF8 (maximum length: 32 bytes)

Unsupported USB formats:

- Empty albums: an empty album is an album that does not contain MP3/WMA files, and will not be shown in the display.

- Unsupported file formats are skipped. For example, word documents (.doc) or MP3 files with extension .dlf are ignored and not played.
- WMA, AAC, WAV, PCM audio files
- DRM protected WMA files (.wav, .m4a, .m4p, .mp4, .aac)
- WMA files in Lossless format

Supported MP3 disc formats

- ISO9660, Joliet
- Maximum title number: 128 (depending on file name length)
- Maximum album number: 99
- Supported sampling frequencies: 32 kHz, 44.1 kHz, 48 kHz
- Supported Bit-rates: 32~256 (kbps), variable bit rates

9 Troubleshooting

Warning

- Never remove the casing of this device.

To keep the warranty valid, never try to repair the system yourself.

If you encounter problems when using this device, check the following points before requesting service. If the problem remains unsolved, go to the Philips Web page (www.philips.com/support). When you contact Philips, make sure that the device is nearby and the model number and serial number are available.

No power

- Make sure that the AC power cord of the device is connected properly.
- Make sure that there is power at the AC outlet.
- As a power-saving feature, the system switches off automatically 15 minutes after track play reaches the end and no control is operated.

No sound

- Adjust the volume.

No response from the unit

- Disconnect and reconnect the AC power plug, then turn on the unit again.
- As a power-saving feature, the system switches off automatically 15 minutes after track play reaches the end and no control is operated.

Remote control does not work

- Before you press any function button, first select the correct source with the remote control instead of the main unit.

- Reduce the distance between the remote control and the unit.
- Insert the battery with its polarities (+/- signs) aligned as indicated.
- Replace the battery.
- Aim the remote control directly at the sensor on the front of the unit.

No disc detected

- Insert a disc.
- Check if the disc is inserted upside down.
- Wait until the moisture condensation at the lens has cleared.
- Replace or clean the disc.
- Use a finalized CD or correct format disc.

Cannot display some files in USB device

- The number of folders or files in the USB device has exceeded a certain limit. This phenomenon is not a malfunction.
- The formats of these files are not supported.

USB device not supported

- The USB device is incompatible with the unit. Try another one.

Poor radio reception

- Increase the distance between the unit and your TV or other radiation sources.
- Fully extend the radio antenna.
- You may purchase a replacement antenna cable with a L-shape plug on one end, as shown below.
 - Connect the L-shape plug to this product, and fit the plug on the other end into your wall socket.

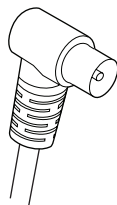

Music playback is unavailable on this unit even after successful Bluetooth connection.

- The device cannot be used to play music through this unit wirelessly.

The audio quality is poor after connection with a Bluetooth-enabled device.

- The Bluetooth reception is poor. Move the device closer to this unit or remove any obstacle between them.

Bluetooth cannot be connected with this unit.

- The device does not support the profiles required for this unit.
- The Bluetooth function of the device is not enabled. Refer to the user manual of the device to find out how to enable the function.
- This unit is not in pairing mode.
- This unit is already connected with another Bluetooth-enabled device. Disconnect that device and then try again.

The paired mobile device connects and disconnects constantly.

- The Bluetooth reception is poor. Move the device closer to this unit or remove any obstacle between them.
- Some mobile phones may connect and disconnect constantly when you make or end calls. This does not indicate any malfunction of this unit.
- For some devices, the Bluetooth connection may be deactivated automatically as a power-saving feature. This does not indicate any malfunction of this unit.

Timer does not work

- Set the clock correctly.
- Switch on the timer.

Clock/timer setting erased

- Power has been interrupted or the power cord has been disconnected.
- Reset the clock/timer.

How to keep clock display on or off in standby?

- In standby, press and hold **CLOCK** to toggle clock display on or off.



Copyright © 2017 Gibson Innovations Limited.

This product has been manufactured by, and is sold under the responsibility of Gibson Innovations Ltd., and Gibson Innovations Ltd. is the warrantor in relation to this product. The Philips trademark and the Philips Shield Emblem are registered trademarks of Koninklijke Philips N.V. used under license.

BTB2670_12_UM_V1.0

