

PHILIPS

Portable speaker

BT6000

User manual



Register your product and get support at
www.philips.com/support

Contents

1	Important	2
----------	------------------	----------

2	Your Bluetooth speaker	2
	Introduction	2
	What's in the box	3
	Overview of the speaker	3

3	Get started	4
	Power supply	4
	Turn on/off	4
	Adjust volume	5

4	Use Bluetooth devices	5
	Connect a device	5
	Play from Bluetooth device	6
	Control your phone call	6
	Disconnect a device	7
	Reconnect a device	7

5	Listen to an external device	8
----------	-------------------------------------	----------

6	Specifications	8
----------	-----------------------	----------

7	Troubleshooting	9
	General	9
	About Bluetooth device	10

8	Notice	10
	Compliance	10
	Care of the environment	10
	Trademark notice	11

1 Important



Warning

- Never remove the casing of this speaker.
 - Never place this speaker on other electrical equipment.
 - Keep this speaker away from direct sunlight, naked flames or heat.
 - Make sure that you always have easy access to the power cord, plug, or adaptor to disconnect the speaker from the power.
-
- Make sure that there is enough free space around the speaker for ventilation.
 - After use under humid circumstance, immediately clean the product with a soft dry cloth.
 - The battery shall not be exposed to excessive heat such as sunshine, fire or the like.
 - The adapter shall not be exposed to dripping or splashing.
 - No objects filled with liquids shall be placed on the adapter.
 - Do not place any sources of danger on the speaker (e.g. lighted candles).
 - Use only power supplies listed in the user manual.
 - Where the plug of the Direct Plug-in Adapter is used as the disconnect device, the disconnect device shall remain readily operable.



Note

- The type plate is located on the bottom of the speaker.

2 Your Bluetooth speaker

Congratulations on your purchase, and welcome to Philips! To fully benefit from the support that Philips offers, register your product at www.philips.com/welcome.

Introduction

This speaker has passed splash-proof test (IPX4) and can be used near water.

With this speaker, you can enjoy audio from Bluetooth-enabled devices or other external devices.

What's in the box

Check and identify the contents of your package:

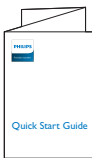
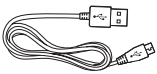
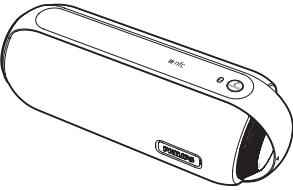

- Speaker
- USB cable for charging
- USB adapter
- Printed materials

Overview of the speaker

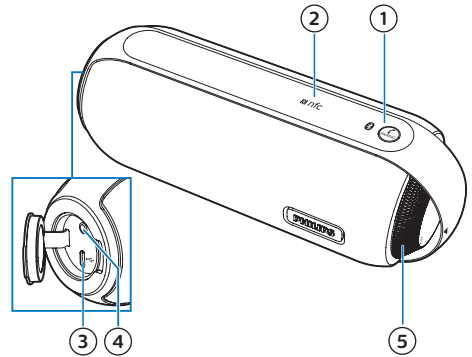

① **r/PAIRING**

- Enter Bluetooth pairing mode.
- After Bluetooth connection, respond to an incoming call.
- Clear Bluetooth pairing information.

② **NFC**

- Connect a NFC compatible device through Bluetooth.

③

- Charge the built-in battery.

④ **AUDIO IN**

- Connect an external audio device.

⑤ **Volume knob (⏻)**

- Turn the speaker on or off.
- Adjust volume.

3 Get started

Always follow the instructions in this chapter in sequence.

Power supply

Either AC power or the built-in battery can be used as power supply of this product.

Option 1: AC power

! Caution

- Risk of product damage! Make sure that the power voltage corresponds to the voltage printed on the back or underside of the speaker.
- Risk of electric shock! When you unplug the AC adapter, always pull the plug from the socket. Never pull the cord.

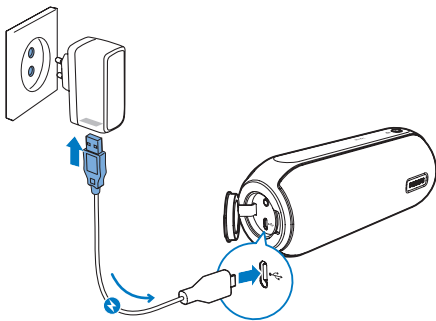

Connect the adapter to:

- the  socket on the speaker.
- the power outlet.

Option 2: Battery power

The speaker can also operate on the built-in rechargeable battery.

≡ Note

- Rechargeable battery has a limited number of charge cycles. Battery life and number of charge cycles vary by use and settings.
- It takes approximately three hours to fully charge the battery.
- The red LED indicator flashes when the battery is low.

To recharge the built-in battery:

- Connect the speaker to AC power.

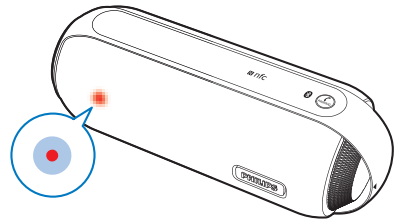

Battery indicator	Battery status
Solid red	Under charging
Off	Fully charged

Turn on/off

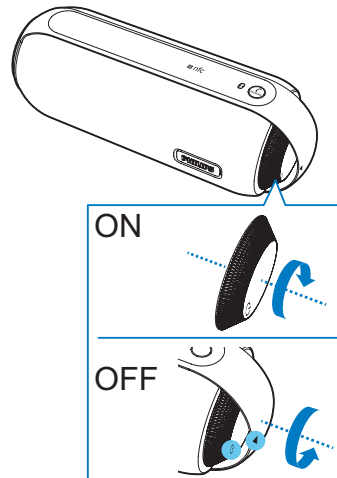

To turn the speaker on or off, rotate the knob clockwise or anticlockwise until you hear a click.

- ↳ When the speaker is turned on, the blue LED indicator flashes.
- ↳ When the speaker is turned off, the blue LED indicator lights off.

Note

- If the battery level is low, the red LED indicator flashes.
- The speaker turns off automatically when being idle for 15 minutes.

Adjust volume

During music playback, rotate the knob to increase or decrease volume.

4 Use Bluetooth devices

With this speaker, you can listen to audio from Bluetooth-enabled devices and control the incoming call through Bluetooth.

Connect a device

Note

- Make sure that Bluetooth function is enabled on your device, and your device is set as visible to all other Bluetooth devices.
- Any obstacle between this speaker and a Bluetooth device can reduce the operational range.
- Keep away from any other electronic device that may cause interference.
- The operational range between this speaker and a Bluetooth device is approximately 10 meters (30 feet).

Option 1: Connect a device through NFC

Near Field Communication (NFC) is a technology that enables short-range wireless communication between various NFC compatible devices, such as mobile phones and IC tags.

If your Bluetooth device supports NFC, you can connect it with this speaker easily.

- 1 Enable NFC on your Bluetooth device (refer to its user manual).
- 2 Turn on the speaker.
 - ↳ The blue LED indicator flashes.

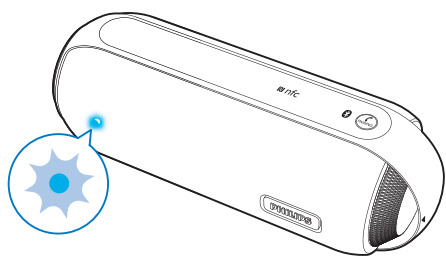

- 3 Tap the NFC tag on the top of the speaker with the NFC area of your Bluetooth device.



- 4 Follow the on-screen instructions to complete the pairing and connection.
 - ↳ After successful connection, the speaker beeps twice, and the LED indicator turns solid blue.

Option 2: Connect a device manually

- 1 On your Bluetooth device, enable Bluetooth and search for Bluetooth devices that can be paired (see the user manual of the device).
- 2 Turn on the speaker.
 - ↳ The blue LED indicator flashes.

- 3 Select **[Philips BT6000]** displayed on your device for pairing. If necessary, input "0000" as the pairing password.

- ↳ After successful connection, the speaker beeps twice, and the LED indicator turns solid blue.
- If you fail to find **[Philips BT6000]** on your device for pairing, press and hold **⏻/PAIRING** for three seconds until you hear beep sound, and then try again.

LED indicator (blue)	Description
Flashing quickly	Ready for pairing
Flashing slowly	Connecting the previously connected device
Solid blue	Connected

Play from Bluetooth device

Note

- Music play pauses when there is an incoming call, and resumes when your phone call ends.

After successful Bluetooth connection, play audio on the Bluetooth device.

- ↳ Audio streams from your Bluetooth device to the speaker.

Control your phone call

After Bluetooth connection, you can control an incoming call with this speaker.

Button	Function
↻/PAIRING	Press to answer an incoming call.
	Press and hold for three seconds to reject an incoming call.
	During a call, press to end the current call.
	During a call, press and hold for three seconds to transfer the call to your mobile device.

Clear pairing information

Press and hold ↻/PAIRING for 8 seconds.

Disconnect a device

- Press and hold ↻/PAIRING for three seconds when there is no incoming call;
- Disable Bluetooth on your device;
or
- Move the device beyond the communication range.
↳ The speaker beeps, and the blue LED indicator flashes.

Note

- Before connecting another Bluetooth device, disconnect the current device first.

Reconnect a device

- When you turn on the speaker, it tries to reconnect the last connected device automatically;
- If not successful, select [**Philips BT6000**] on your Bluetooth menu to start reconnection.

5 Listen to an external device

With this speaker, you can also listen to an external audio device such as an MP3 player.

Note

- Make sure that music playback through Bluetooth is stopped.

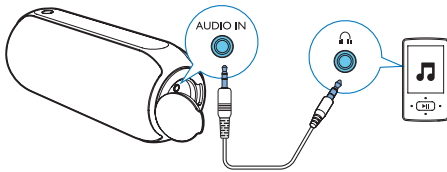

- 1 Open the protective cover on the left of the speaker.
- 2 Connect an audio input cable (not supplied) with a 3.5 mm connector on both ends to
 - the **AUDIO IN** socket on this speaker, and
 - the headphone socket on the external device.
- 3 Play audio on the external device (refer to its user manual).

Tip

- When you start music streaming from a connected Bluetooth device, the speaker switches to the Bluetooth source automatically.

6 Specifications

Note

- Product information is subject to change without prior notice.

Rated output power (Amplifier)	12W RMS
Acoustic frequency response	100-20000 Hz
Speaker driver	2 x 1.5" full range, 8 Ω
Bass enhancement	2 x passive radiator
Bluetooth version	V4.0
Bluetooth supported profiles	HFP V1.5, A2DP V1.2, AVRCP V1.4
Bluetooth frequency band / Output power	2.400GHz ~ 2.483GHz ISM Band / \leq 4dBm (Class 2)
NFC frequency	13.56 MHz
AUX input level	650mV RMS
Water resistance	IPX4
Power Supply	
- AC Power (power adapter)	Brand name: PHILIPS; Model: AKN2G-0500200VU; Input: 100-240 V~, 50/60 Hz, 0.35 A; Output: 5 V \equiv 2 A;
- Built-in battery	Li-ion battery (3.7 V, 4400 mAh)
Play time in battery mode	Approx. 8 hours

Standby Power Consumption	< 1 W
Eco Standby Power Consumption	< 0.5 W
Dimensions - Main unit (W x H x D)	188 x 71 x 70 mm
Weight - Main unit	0.5 kg

7 Troubleshooting



Warning

- Never remove the casing of this device.

To keep the warranty valid, never try to repair the system yourself.

If you encounter problems when using this device, check the following points before requesting service. If the problem remains unsolved, go to the Philips Web page (www.philips.com/support). When you contact Philips, make sure that the device is nearby and the model number and serial number are available.

General

No power

- Make sure that the AC power plug of the speaker is connected properly.
- Make sure that there is power at the AC outlet.
- Recharge your speaker.

No sound

- Adjust volume on this product.
- Adjust volume on the connected device.
- Make sure that your Bluetooth device is within the effective operational range.

No response from the speaker

- Disconnect and reconnect the power plug, then turn on the speaker again.
- Recharge the speaker.

The LED indicator is solid red, and the speaker has no response when pressing any key.

- The speaker is in DEMO mode. To exit this mode: after connecting to AC power, press and hold **⏻/PAIRING**, turn on the speaker, then release the **⏻/PAIRING** key after 15 seconds.

About Bluetooth device

The audio quality is poor after connection with a Bluetooth-enabled device.

- The Bluetooth reception is poor. Move the device closer to this product or remove any obstacle between them.

Fail to find [Philips BT6000] on your device for pairing.

- Press and hold **⏻/PAIRING** for three seconds, and then try again.

Cannot connect with the device.

- The Bluetooth function of the device is not enabled. Refer to the user manual of the device for how to enable the function.
- This product is already connected with another Bluetooth-enabled device. Disconnect that device and then try again.

The paired device connects and disconnects constantly.

- The Bluetooth reception is poor. Move the device closer to this product or remove any obstacle between them.
- For some devices, Bluetooth connection may be deactivated automatically as a power-saving feature. This does not indicate any malfunction of this product.

8 Notice

Any changes or modifications made to this device that are not expressly approved by Gibson Innovations may void the user's authority to operate the equipment.

Compliance

Hereby, Gibson Innovations declares that this product is in compliance with the essential requirements and other relevant provisions of Directive 2014/53/EU. You can find the Declaration of Conformity on www.philips.com/support.

Care of the environment

Disposal of your old product and battery



Your product is designed and manufactured with high quality materials and components, which can be recycled and reused.



This symbol on a product means that the product is covered by European Directive 2012/19/EU.



This symbol means that the product contains a built-in rechargeable battery covered by European Directive 2013/56/EU which cannot be disposed

of with normal household waste. We strongly advise you to take your product to an official collection point or a Philips service centre to have a professional remove the rechargeable battery. Inform yourself about the local separate collection system for electrical and electronic products and rechargeable batteries. Follow local rules and never dispose of the product and rechargeable batteries with normal household waste. Correct disposal of old products and rechargeable batteries helps prevent negative consequences for the environment and human health.

! Caution

- Removal of the built-in battery invalidates the warranty and may destroy the product.

Always bring your product to a professional to remove the built-in battery.

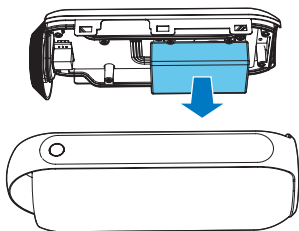

Environmental information

All unnecessary packaging has been omitted. We have tried to make the packaging easy to separate into three materials: cardboard (box), polystyrene foam (buffer) and polyethylene (bags, protective foam sheet.)

Your system consists of materials which can be recycled and reused if disassembled by a specialized company. Please observe the local regulations regarding the disposal

of packaging materials, exhausted batteries and old equipment.

Trademark notice



The Bluetooth® word mark and logos are registered trademarks owned by Bluetooth SIG, Inc. and any use of such marks by Gibson Innovations Limited is under license. Other trademarks and trade names are those of their respective owners.



The N Mark is a trademark or registered trademark of NFC Forum, Inc. in the United States and in other countries.



This is CLASS II apparatus with double insulation, and no protective earth provided.



Copyright © 2016 Gibson Innovations Limited. Revised Edition © 2017

This product has been manufactured by, and is sold under the responsibility of Gibson Innovations Ltd., and Gibson Innovations Ltd. is the warrantor in relation to this product. Philips and the Philips Shield Emblem are registered trademarks of Koninklijke Philips N.V. and are used under license.

BT6000MKII_12_UM_V2.0

