

PHILIPS

AZ 8352 CD Radio Cassette Recorder

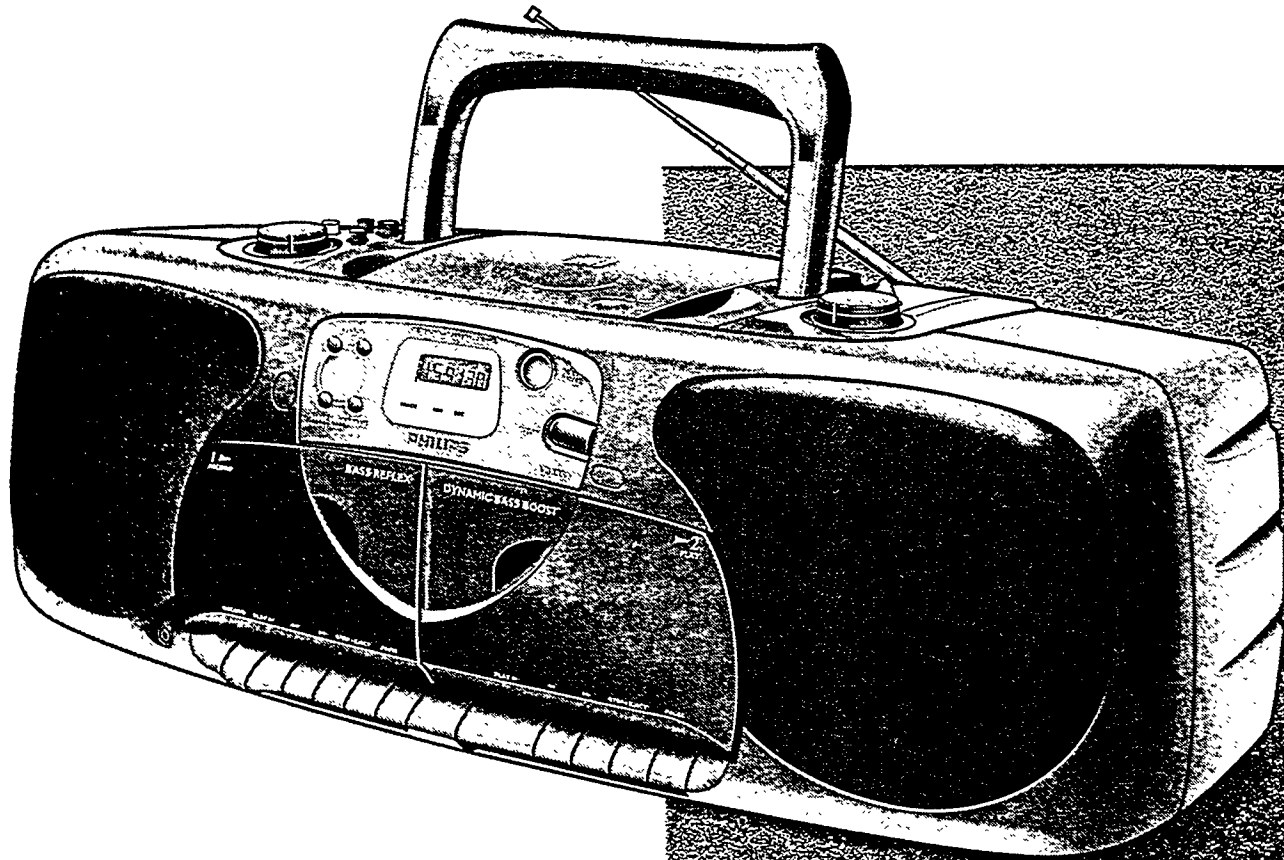

Instructions for use
Mode d'emploi
Instrucciones de manejo
Bedienungsanleitung
Gebruiksaanwijzing
Istruzioni per l'uso
Manual de utilização
Brugsanvisning
Bruksanvisning
Käyttöohje
Οδηγίες χρήσεως



PHILIPS

CLASS 1 LASER PRODUCT

IMPORTANT NOTES FOR USERS IN THE U.K.

Mains plug

This apparatus is fitted with an approved moulded 13 Amp plug. To change a fuse in this type of plug proceed as follows:

- Remove fuse cover and fuse.
- Fix new fuse which should be a BS1362 5 Amp, A.S.T.A. or BSI approved type.
- Refit the fuse cover.

If the fitted plug is not suitable for your socket outlets, it should be cut off and an appropriate plug fitted in its place.

If the mains plug contains a fuse, this should have a value of 5 Amp. If a plug without a fuse is used, the fuse at the distribution board should not be greater than 5 Amp.

Note: The severed plug must be disposed to avoid a possible shock hazard should it be inserted into a 13 Amp socket elsewhere.

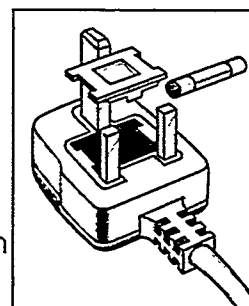

How to connect a plug

The wires in the mains lead are coloured with the following code: blue = neutral (N), brown = live (L). As these colours may not correspond with the colour markings identifying the terminals in your plug, proceed as follows:

- Connect the blue wire to the terminal marked N or coloured blue or black.
- Connect the brown wire to the terminal marked L or coloured brown or red.
- Do not connect either wire to the earth terminal in the plug, marked E (or \perp) or coloured green (or green and yellow).

Before replacing the plug cover, make certain that the cord grip is clamped over the sheath of the lead - not simply over the two wires. If in doubt, consult a qualified electrician.

(E) España

Declaración de conformidad con normas
El que suscribe, en nombre y representación de:

**Consumer Electronics Factory
Philips Hong Kong Ltd.**

declara, bajo su propia responsabilidad, que el

equipo: **Radiocasete/CD**
fabricado por: **Consumer Electronics
Factory**
en: **Far East**
marca: **Philips**
modelo: **AZ 8352**

objeto de esta declaración, cumple con la
normativa siguiente: Reglamento sobre
Perturbaciones Radioeléctricas,
Real Decreto 138/1989, Anexo V.

Hecho en: **Hong Kong, 01 - 04 - 1995**

Firma:



Nombre: **T.M. Siu**
Cargo: **Quality manager**

(MEX) México

NOM



Es necesario que lea cuidadosamente su
instructivo de manejo.

(N) Norge

Typeskilt finnes på apparatens underside.

Observer: Nettbryteren er sekundert innkopleet.
Den innebygde nettdelen er derfor ikke frakopleet
nettets så lenge apparatet er tilsluttet nettkon-
takten.

Englishpage 4 **English**

Françaispage 12 **Français**

Españolpágina 20 **Español**

Deutschpage 28 **Deutsch**

Nederlandspage 36 **Nederlands**

Italianopagina 44 **Italiano**

Portugûespágina 52 **Portugûes**

Danškside 60 **Dansk**

Svenskasida 68 **Svenska**

Suomisivu 76 **Suomi**

Ἑλληνικάσελίδα 84 **Ἑλληνικά**

1. GENERAL

2. SUPPLY

CONTENTS

1. GENERAL	4
2. SUPPLY	4
3. CONTROLS and CONNECTIONS	5
4. BACK PANEL	6
5. RADIO	6
6 CD PLAYER	7-8
7. CASSETTE DECKS	9-10
8. MAINTENANCE	10
9. TROUBLESHOOTING	11

RECYCLING

Please observe the local regulations regarding the disposal of packing materials, exhausted batteries and old equipment.

- All redundant packaging material has been omitted. We have done our utmost to make the packaging easy separable into three mono-materials:
 - cardboard (box)
 - expandable polystyrene (buffer)
 - polyethylene (bags, protective foam sheet)
- Your set consists of materials which can be recycled if disassembled by a specialized company.
- Do not dispose of exhausted batteries with your household waste.

The type plate is located on the base of the set

This product complies with the radio interference requirements of the European Community.

Recording is permissible insofar as copyright or other rights of third parties are not infringed.

SUPPLY

Battery supply

- Open the battery compartment and insert as indicated six batteries, type R20, UM1 or D-cells.

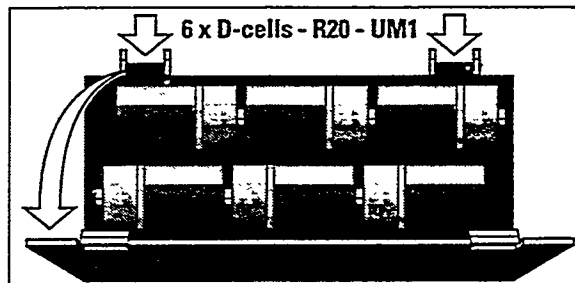

- Remove the batteries if exhausted or if they will not be used again for a long period. The battery supply is switched off when the set is connected to the mains. To change over to battery supply, pull out the plug from the MAINS socket ⑬.

Mains supply

- Check if the mains voltage as shown on the type plate (on the base of the set) corresponds to your local mains voltage. If it does not, consult your dealer or service organisation. If the set is equipped with a VOLTAGE selector ⑭, set this selector to the local mains voltage.

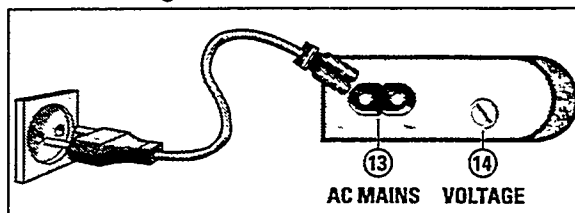

- Connect the mains lead to the MAINS socket ⑬ and the wall socket. The mains supply is switched on.
- To disconnect the set from the mains completely, withdraw the mains plug from the wall socket.

Important note for users in the U.K.

When fitting a mains plug, follow the instructions as shown on page 2.

3. CONTROLS and CONNECTIONS

English

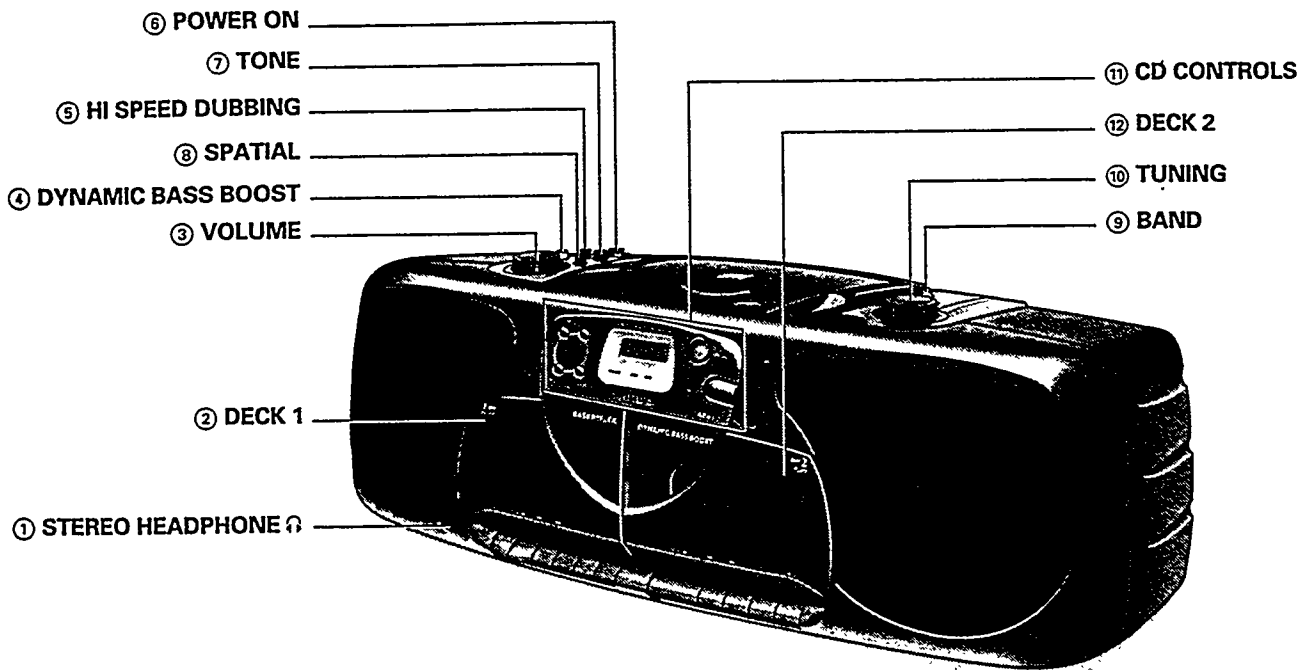

TOP AND FRONT PANEL

- ① stereo headphone socket
- ② **DECK 1 - cassette deck 1 keyboard**
(recording/playback):
RECORD ●
PLAY ►
REWIND ◀◀ - fast rewind
F.FWD ▶▶ - fast forward wind
STOP ■
PAUSE ||
- ③ **VOLUME** control
- ④ **DYNAMIC BASS BOOST** - press to boost the bass response
- ⑤ **HI SPEED DUBBING** - press to copy a cassette at high speed
- ⑥ **POWER ON** - to select the sound source
TAPE/OFF - RADIO - CD
- ⑦ **TONE** control
- ⑧ **SPATIAL** button - press to obtain a spatial sound effect (only when the sound source is stereo)
- ⑨ **BAND** selector - to select the wave band
- ⑩ **TUNING** knob
- ⑪ **CD - buttons and display**
◀◀ PREVIOUS/NEXT ▶▶:
 - in position playback or STOP, press briefly to jump to a previous ◀◀ or next ▶▶ track
 - during playback, keep pressed to search fast backward ◀◀ or forward ▶▶**PROGRAM** - press briefly to programme the displayed track number
 press longer than 1 second to display all stored track numbers

- MODE** - press so many times until the required function appears in the display:
 - **SHUFFLE** play all tracks in a random order
 - **SHUFFLE REPEAT** continuously repeat the CD in the SHUFFLE mode
 - **REPEAT ALL (PROGRAM)** continuously repeat the CD (or the stored selection - PROGRAM)
 - **REPEAT 1** continuously repeat 1 title**DISPLAY**
 - **TRACK** the total number of tracks, and during playback the number of the track being played
 - **MIN/SEC** the total playing time of the CD, and during PLAY the elapsed time of that track**OPEN-CLOSE** - to open the CD door
PLAY-PAUSE ► play and pause button
STOP ■ button
- ⑫ **DECK 2 - cassette deck 2 keyboard**
(playback only):
PLAY ►
REWIND ◀◀ - fast rewind
F.FWD ▶▶ - fast forward wind
STOP ■
PAUSE ||

STEREO HEADPHONE SOCKET ①

You can connect stereo headphones having a 3.5 mm plug to the socket ①. Inserting the plug will disconnect the speakers.

4. BACK PANEL

5. RADIO

English

BACK PANEL

- ⑬ **AC MAINS** - socket for mains lead
- ⑭ **VOLTAGE** selector (not on all versions)
- ⑮ **BATTERIES** - battery compartment
- ⑯ **MIC** - socket for external microphone

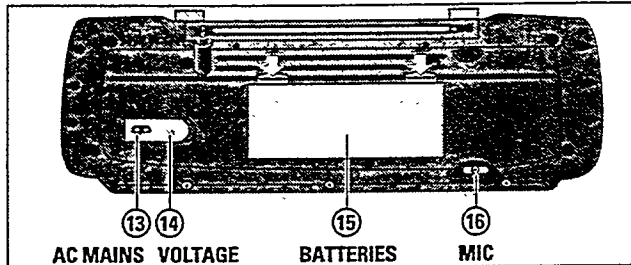

MICROPHONE SOCKET ⑯ (on the back)

For recording, you can connect a mono microphone having a 3.5 mm plug to the MIC socket ⑯, see CASSETTE RECORDING.

RADIO RECEPTION

- Set the POWER ON selector ⑥ to RADIO.
- Adjust the sound using the controls VOLUME ③ and DYNAMIC BASS BOOST ④, using TONE ⑦ and SPATIAL ⑧.
- Select the wave band using BAND selector ⑨.
(LW and SW not on all versions)
- Tune to a radio station using the TUNING knob ⑩.
 - For FM, pull out the telescopic aerial. To improve FM-reception, incline and turn the aerial. Reduce its length if the FM-signal is too strong (very close to a transmitter).
 - For AM/MW and LW, the set is provided with a built-in aerial, so the telescopic aerial is not needed. Direct the aerial by turning the whole set.
 - For SW, the telescopic aerial must be pulled out and placed in the vertical position. To improve reception, vary the length of the aerial.
- The set is switched off when the POWER ON selector ⑥ is in position TAPE/OFF and the recorder buttons are released.

6. CD PLAYER

CD HANDLING AND MAINTENANCE

- Use only Digital Audio CDs.
- To take the CD out of its box easily, press the centre spindle while lifting the CD.

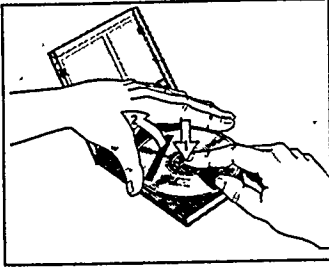

- Never write on a CD or attach any sticker to the CD.
- Always hold the CD at the edge and always store it in its box after use, label facing up.
- To remove dust and dirt, breathe on the CD and wipe it with a soft, lint-free cloth in a straight line from the centre towards the edge. Cleaning agents may damage the CD!
- Do not expose the CD to rain, moisture, sand, or to excessive heat e.g. from heating equipment or in motor cars parked in the sun.

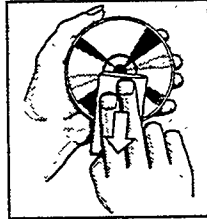

PLAYING A CD

- Set the POWER ON selector ⑥ to CD.
- Press OPEN-CLOSE to open the CD door.
- Insert the AUDIO CD, printed side facing up.
- Close the door. The CD-player starts and scans the contents list of the CD.

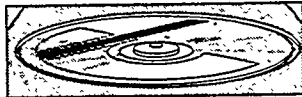

After that, the total playing time and the number of tracks appear on the display and the CD-player stops.



- Playback will start by pressing PLAY ►. As soon as playback starts, the display shows the track number and the elapsed playing time.



- Adjust the sound using the controls VOLUME ③ and DYNAMIC BASS BOOST ④, TONE ⑦ and SPATIAL ⑧.
- For brief interruptions, press PLAY-PAUSE ►. The word PAUSE then appears. To continue playback, press PLAY-PAUSE ► again.
- To stop playback, press STOP ■. The CD player also goes to position STOP:
 - by pressing OPEN-CLOSE ;
 - when the end of the CD is reached;
 - if you move the POWER ON selector ⑥;
 - if the batteries run down or if the power supply is interrupted.
- To take out the CD, open the CD door by pressing OPEN-CLOSE . Open the CD door only if the CD-player is in position STOP.
- The set is switched off when the POWER ON selector ⑥ is in position TAPE/OFF and the recorder buttons are released.



MODE (SHUFFLE and REPEAT)

By pressing the MODE button several times, all play modes will successively appear on the display:

- 1 x **SHUFFLE** to play all tracks in a random order;
- 2 x **SHUFFLE REPEAT** to repeat the CD continuously in a random order;
- 3 x **REPEAT ALL** to repeat the CD (or the programmed selection PROGRAM) continuously;
- 4 x **REPEAT 1** to repeat the actual title continuously.
- 5 x **normal** (no indication) to defeat the SHUFFLE and REPEAT modes.

To defeat the REPEAT and SHUFFLE modes, choose the normal position (no display indication).

6. CD Player

◀◀ PREVIOUS/NEXT ▶▶

By pressing *briefly* the NEXT or PREVIOUS button, you can jump to a next or previous title, or you can select a track before starting playback.

a. During PLAY

NEXT ▶▶ - go to the next track (title)

You can jump to the next title by pressing NEXT ▶▶ once.

If you want to skip more than one track, press NEXT ▶▶ more than once until the display shows the desired track number.

PREVIOUS ◀◀ - go to the previous track (title)

If you want to repeat the running title from the beginning, press PREVIOUS ◀◀ once.

If you want to repeat one of the previous titles, press PREVIOUS ◀◀ more than once until the display shows the required track number.

b. In position STOP

In position STOP with a CD inserted you can select the desired title using PREVIOUS ◀◀ or NEXT ▶▶ until the display shows the required track number. Press PLAY ▶ to start playback.

SEARCH FORWARD ▶▶ / BACKWARD ◀◀

By *keeping pressed* the NEXT or PREVIOUS button *during playback*, you can search for a particular passage within a track. The CD is played partly and at high speed, however, the sound is still recognizable.

- During playback, keep NEXT ▶▶ for search forward and PREVIOUS ◀◀ for search backward pressed.
- Release the button as soon as you recognize the required passage: the CD will be played in the normal way from this passage. If the button is pressed longer than 5 seconds, the search speed increases.

PROGRAMMING TRACK NUMBERS

You may select a number of tracks and store these in the memory in the desired sequence. You may store any track more than once. When playing, you will only hear the stored titles in the selected sequence. At most, 20 tracks can be stored in the memory. When the memory is full, the character *F* (FULL) appears.

Manual selecting

- Load the CD, but do not press PLAY ▶ yet.
- Select the desired track using the buttons ◀◀ PREVIOUS and NEXT ▶▶ until the display shows the required track number.
- Store this track by pressing PROGRAM; the character *F* appears, indicating that the track has been stored.
- Select and store in this way all desired titles.

Storing during PLAY

- During normal PLAY you may store the running title by pressing PROGRAM; the character *F* appears, indicating that the track has been stored.

Checking the program

- From the STOP-position, keep the PROG button pressed: the display shows in sequence all programmed track numbers.

Erasing a program

- You can erase the contents of the memory:
 - by pressing STOP twice: the character *C* for CLEAR appears;
 - by opening the CD door using OPEN-CLOSE ;
 - if you move the POWER ON selector ⑥;
 - if the batteries get exhausted or if the power supply is interrupted.

How to play the stored selection

- To play your selection, the CD-player should be in position STOP; then press PLAY ▶: now, the word PROGRAM appears.
- To repeat the selection continuously, choose the mode REPEAT ALL.
- Playing the selection in the SHUFFLE or SHUFFLE REPEAT mode is not possible.

7. CASSETTE DECK

COMPACT CASSETTES

- For recording, use a NORMAL cassette (IEC type I) on which the tabs are not broken out. This deck is not suited for recording on CHROME (IEC II) or METAL (IEC IV) cassettes.
- For playback, any cassette type may be inserted.
- At the very beginning and end of the tape, no recording will take place during the 7 seconds when the leader tape passes the recorder heads.
- To prevent the accidental erasure of a recording,

keep the cassette side to be safeguarded in front of you and break out the left tab. Now, recording on this side is no longer possible.

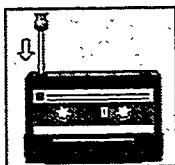

To render this safeguard ineffective, cover the aperture with a piece of adhesive tape.

- Do not expose the cassettes to rain, moisture, sand, or to excessive heat e.g. from heating equipment or in motor cars parked in the sun.

CASSETTE RECORDING (on deck 1 only)

Preparation

During recording, the deck 2 buttons should not be pressed (except for PLAY ► during dubbing).

- On deck 1, press STOP ■ to open the cassette holder.
- Insert the cassette into deck 1.
- When monitoring during recording, adjust the sound using the controls VOLUME ③ and DYNAMIC BASS BOOST ④ and, TONE ⑦ and SPATIAL ⑧. These controls do not affect the recording.
- For fast winding, press REWIND ◀◀ or F.FWD ▶▶. To stop, press STOP ■.

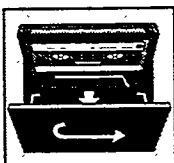

CD synchro start - recording from the CD-player

- Set the POWER ON selector ⑥ to CD. It's not necessary to start the CD-player separately: by pressing RECORD ● the CD-player starts automatically:
 - if the CD-player is in position STOP, recording will start from the beginning of the CD (or from the beginning of the programmed selection);
 - if the CD-player is in position PAUSE, recording will start from this position.

Recording from the radio

- Set the POWER ON selector ⑥ to RADIO.

Microphone recording

- Set the POWER ON selector ⑥ to TAPE.
- Set the HI SPEED DUBBING button ⑤ to normal speed
- Do not press this button during recording
- Connect a mono microphone having a 3.5 mm plug to the MIC socket ⑩ (on the back).
- Set the VOLUME control ③ to MIN. (monitoring during microphone recordings is not possible).

Starting and stopping the recording

- Start recording by pressing RECORD ●.
- For brief interruptions, press PAUSE II. To restart recording, press this button once more.
- To stop recording, press STOP ■. On pressing again, the cassette holder will open.
- The set is switched off when the POWER ON selector ⑥ is in position TAPE/OFF and the recorder buttons are released.

DUBBING - Copying from deck 2 to 1

When copying, it is recommended to use fresh batteries or to connect the set to the mains supply.

- Set the POWER ON selector ⑥ to TAPE. Do not move this selector during dubbing.
- Set the HI SPEED DUBBING button ⑤ to:
 - ■ for normal speed copying;
 - ◡ for high speed copying.Do not press this button during dubbing.
- Press both STOP ■ buttons and insert a recorded cassette into deck 2 and a cassette which is suited for recording into deck 1.
- Press on deck 1 PAUSE II and then RECORD ●.
- To start dubbing, press PLAY ► on deck 2. PAUSE II is then released.
- By pressing PAUSE II on deck 1, you can omit undesired passages while deck 2 continues. To restart copying, press PAUSE II once more.
- Using PAUSE II of deck 2, deck 1 will record a blank part.
- To stop dubbing, press both STOP ■ buttons; the set is then switched off.

7. CASSETTE DECK

8. MAINTENANCE

English

CASSETTE PLAYBACK

Playback on deck 1 or 2

Deck 1 will not play if the PLAY ► button on deck 2 is pressed.

- Set the POWER ON selector ⑥ to TAPE.
- Press STOP ■ to open the cassette holder.
- Insert a recorded cassette.
- For fast winding, press ◀◀ or ▶▶. To stop, press STOP ■.
- Press PLAY ► and playback will start.
- Adjust the sound using the controls VOLUME ③ and DYNAMIC BASS BOOST ④, using TONE ⑦ and SPATIAL ⑧.
- To stop, press STOP ■; the set is then switched off.

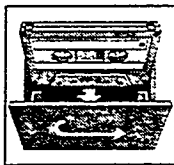

On pressing again, the cassette holder will open.

When the end of the tape is reached, the recorder buttons are released.

CONTINUOUS PLAY - deck 2 followed by deck 1

- Set the POWER ON selector ⑥ to TAPE.
 - Press both STOP ■ buttons and insert a recorded cassette into both decks.
 - Press on deck 2 PLAY ► and on deck 1 PAUSE || and PLAY ►: deck 2 will play and deck 1 stands still.
- As soon as deck 2 stops (at the end of the cassette or when its STOP ■ button is pressed), PAUSE || is released and deck 1 will start playing back.
- To stop, press STOP ■; the set is then switched off.

GENERAL

- The mechanical parts of the CD player and the cassette decks contain self-lubricating bearings and must not be oiled or lubricated.
- A chamois leather slightly moistened with water is sufficient for cleaning the housing.
- Do not use cleaning agents as these may harm the housing.
- Do not leave the set, batteries, CDs or cassettes for any length of time in direct sunlight or other places where high temperatures can occur, such as in the vicinity of heating apparatus.
- Do not expose the set, batteries, CDs or cassettes to humidity or rain.

CD-PLAYER MAINTENANCE

- The lens (X) must not be cleaned.

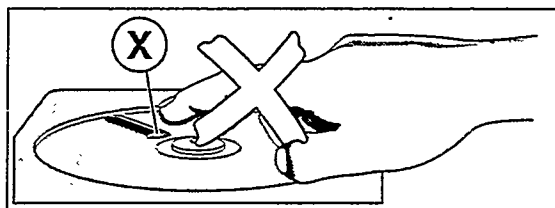

- The lens may cloud over if the CD player is moved from cold to warm surroundings. The CD player will not start. Do not clean the lens, but give the player some time to acclimatise.

CASSETTE DECK MAINTENANCE

To ensure a good recording and playback quality, clean the indicated parts (A)(B)(C) after every 50 hours of operation or, on average, once a month.

- Open the cassette holder using STOP ■.
- Use a cotton bud slightly moistened with alcohol or a special head cleaning fluid.
- Press PLAY ► and clean the rubber pressure rollers (C).
- Then press PAUSE || and clean the capstans and the heads (A).
- After cleaning, press STOP ■.

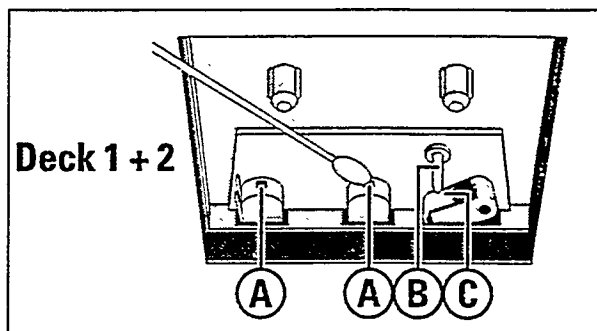

- Cleaning of the heads (A) can also be done by playing a cleaning cassette through once.

9. TROUBLESHOOTING

TROUBLESHOOTING

If a fault occurs, first check the points listed below before taking the set for repair. If you are unable to remedy a problem by following these hints, consult your dealer or service centre.

WARNING

Under no circumstances should you try to repair the set yourself, as this would invalidate the guarantee.

PROBLEM

- POSSIBLE CAUSE
- REMEDY

No sound

- VOLUME is not adjusted
- Adjust the VOLUME
- Headphones are connected
- Disconnect headphones
- Batteries are exhausted
- Insert fresh batteries
- Batteries are incorrectly inserted
- Insert the batteries correctly
- Mains lead is not securely connected
- Connect the mains lead properly

Poor radio reception

- Weak radio aerial signal
- Aim the aerial for best reception:
 - FM: incline and rotate telescopic aerial
 - AM (MW/LW): rotate the entire set
 - SW: extend telescopic aerial vertically
- Interference caused by the vicinity of electrical equipment like TVs, video recorders, computers, thermostats, fluorescent lamps (TL), engines etc.
- Keep the radio away from electrical equipment

NO DISC or ERROR indication

- CD is badly scratched or dirty
- Replace or clean the CD, see Maintenance
- No CD inserted
- Insert CD
- CD inserted upside down
- Insert CD with printed side facing up
- Laser lens is steamed up
- Wait until lens has acclimatized

The CD skips tracks

- CD is damaged or dirty
- Replace or clean the CD
- SHUFFLE or PROGRAM is active
- Switch off SHUFFLE or PROGRAM play

Poor cassette sound quality

- Dust and dirt on the heads, capstan or pressure roller
- Clean the heads, capstan and pressure roller, see Maintenance

Recording does not work

- Cassette tab(s) may be broken out
- Apply a piece of adhesive tape over the missing tab space

English.....page 4

Français.....page 12

Españolpágina 20

Deutsch.....page 28

Nederlands.....page 36

Italianopagina 44

Português.....página 52

Danskside 60

Svenskasida 68

Suomisivu 76

Ελληνικάσελίδα 84

