

# PHILIPS

AZ 7594 Portable Compact Disc Player

AZ 7595

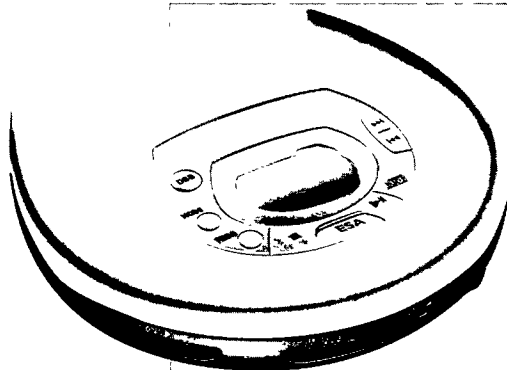

Instructions for use  
Mode d'emploi  
Instrucciones de manejo  
使用説明書



**PHILIPS**



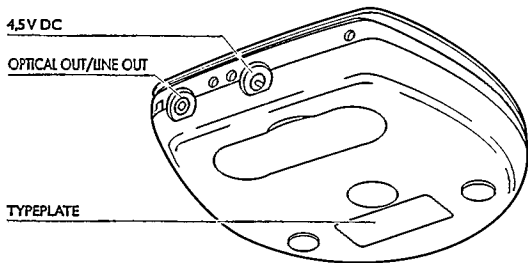
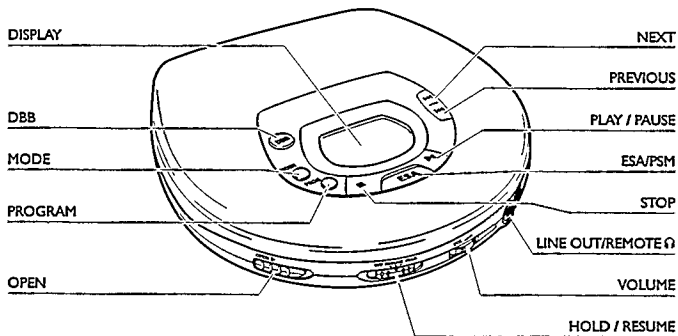

---

## **Australia**

Guarantee and Service.....page 62

## **Mexico**

Es necesario que lea cuidadosamente su instructivo de manejo.

**NOM**

Garantía .....pág. 64

## **New Zealand**

Guarantee and Service.....page 65

|                |                    |      |                           |       |
|----------------|--------------------|------|---------------------------|-------|
| <b>English</b> | Controls .....     | 6    | Operation .....           | 12-16 |
|                | Power Supply ..... | 7-8  | General information ..... | 17    |
|                | Connections .....  | 9-11 | Troubleshooting .....     | 18-19 |

**English**

|                 |                    |       |                               |       |
|-----------------|--------------------|-------|-------------------------------|-------|
| <b>Français</b> | Commandes .....    | 20    | Fonctionnement .....          | 26-30 |
|                 | Alimentation ..... | 21-22 | Généralités .....             | 31    |
|                 | Branchements ..... | 23-25 | Recherche des<br>pannes ..... | 32-33 |

**Français**

|                |                   |       |                                |       |
|----------------|-------------------|-------|--------------------------------|-------|
| <b>Español</b> | Mandos .....      | 34    | Funcionamiento.....            | 40-44 |
|                | Alimentación..... | 35-36 | Información general.....       | 45    |
|                | Conexiones.....   | 37-39 | Detección de<br>anomalías..... | 46-47 |

**Español**

|           |            |       |            |       |
|-----------|------------|-------|------------|-------|
| <b>中文</b> | 控制器 .....  | 48    | 操作 .....   | 54-58 |
|           | 電源供給 ..... | 49-50 | 一般說明 ..... | 59    |
|           | 連接 .....   | 51-53 | 故障排除 ..... | 60-61 |

**中文**

# CONTROLS

please refer to the illustration on page 3

English

- DISPLAY** ..... shows the different playing modes, tracks, and times
- ▶▶ ..... skips and searches forward
- ◀◀ ..... skips and searches backward
- VOLUME** ..... adjusts the volume level at the headphone socket
- RESUME/HOLD** ..... activates the RESUME function and/or HOLD function (locking all buttons)
- MODE** ○ ..... selects the different playing modes: SHUFFLE→SHUFFLE REPEAT ALL→REPEAT→REPEAT ALL→SCAN→off
- PROG P** ..... stores tracks in a program and reviews the program
- DBB** ..... **Dynamic Bass Boost:** enhances the bass response, DBB 1→DBB 2→DBB 3→off  
**Press this button for more than 3 seconds to switch off/on acoustic feedback.**
- STOP** ■ ..... stops CD play, deletes various settings, switches off the CD player, and activates charging.
- OPEN** ..... opens the lid of the CD player
- ▶|| ..... starts and pauses CD play
- ESA / PSM** ..... **Electronic Shock Absorption** is the buffer memory for uninterrupted sound/**Power Save Mode** is for maximum battery playtime. ESA→PSM→off
- LINE OUT/**
- REMOTE** Ⓞ ..... Headphone and remote control socket (3.5 mm)
- OPTICAL OUT** ..... connects the CD player to a (optical) digital/analog in socket on an amplifier or a digital recorder by means of an optical cable or a signal lead
- 4.5 V DC** ..... Socket for external power supply

*Notes: -The display is backlit for several seconds after key operations.*

*-Status feedback (e.g. PAUSE, battery empty, etc.) and key operations are accompanied by an acoustic signal through the headphone.*

***This set complies with the radio interference requirements of the European Community.***

# POWER SUPPLY

English

## Mains adapter (supplied or optionally available)

AY 3160 mains adapter 4.5 V/400 mA direct current, positive pole to the center pin

- 1 Make sure that the local voltage corresponds to the voltage of the adapter.
- 2 Connect the mains adapter to the player's 4.5 V DC socket and to the wall outlet.

*Note: -Use only the AY 3160 adapter, other products may damage the set.  
-No acoustic feedback when using the adapter.*

*-Always disconnect the adapter when you are not using it.*

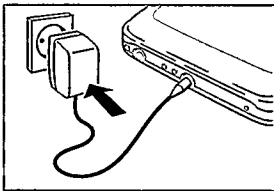

## Batteries, type LR6, UM3 or AA (supplied or optionally available)

Open the battery compartment and insert 2 alkaline batteries or the rechargeable battery pack.

Typical playing times under normal conditions:

Alkaline batteries: 15 hours (ESA off)  
12 hours (ESA on)  
18 hours (PSM on)

Remove batteries if empty or if the CD player is not to be used for a longer period of time.

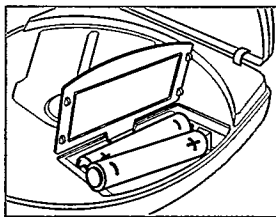

*Note: The battery condition will be indicated in the display:*

*-Full batteries: no indication.*

*-Weak batteries:  - symbol flashes. This symbol is not available when rechargeable batteries are used.*

*-Empty batteries:  -symbol flashes and the message  $\text{b} \text{A} \text{L} \text{t}$  appears.*

*-Replace the batteries or connect the mains adapter.*

**Batteries contain chemical substances, therefore they should be disposed of properly.**

# POWER SUPPLY

English

## Recharging the Philips battery pack on board (supplied or optionally available)

AY 3360 NiMH/AY 3361 NiCd battery pack for recharging on board

The battery pack will be recharged if the mains adapter is connected, the set is switched off and you press the STOP ■ button.

→ Display indication during charging: *CHARGE* and 

Approx. charging time: 5.5 hours (NiMH)

3.5 hours (NiCd)

→ Display indication when fully charged: *FULL* and 

*Note: - Use only the Philips battery pack, as other rechargeable batteries cannot be recharged on board.*

*- To ensure a long life for your battery pack, charging will be interrupted automatically at high ambient temperatures (Display indication: *HOT*).*

## Battery Box (supplied or optionally available)

Attach the battery box AY 3770 to the CD player and insert 2 alkaline batteries.

For maximum playtime (app. 40 hours) use new alkaline batteries in the battery box and in the CD Player. **Do not use rechargeable batteries in combination with alkaline batteries.**

*Note: - Rechargeable battery packs cannot be used in the battery box.*

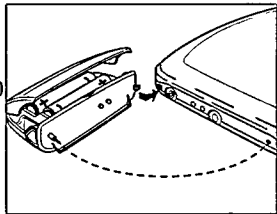



# CONNECTIONS

## Connecting the headphones (supplied)

Connect the supplied headphones with the LINE OUT/ REMOTE  jack.

AY 3675

*Note : Use this jack also for connecting your HiFi system (signal lead) or your car radio (adapter cassette or signal lead). In both cases, the volume of the CD player has to be set to position 8.*

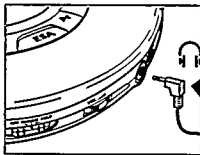

English

## Use your head when using headphones

**Hearing safety:** Do not play your headphones at a high volume. Hearing experts advise that continuous use at high volume can permanently damage your hearing.

**Traffic safety:** Do not use headphones while driving a vehicle. It may create a hazard and it is illegal in many countries. Even if your headphones are an open-air type designed to let you hear outside sounds, do not turn up the volume so high that you cannot hear what is going on around you.

# CONNECTIONS

English

## Connecting the remote control (supplied or optionally available)

AY 3764 cord remote control

AY 3765 LCD cord remote control

The buttons on the remote control have the same functions as the corresponding ones on the CD player.

**VOLUME:** to adjust the main volume that has been preset (position 8) with the volume control on the CD player.

- 1 Switch off the CD player (press STOP ■ twice).
- 2 Connect the remote control **firmly** to the LINE OUT/REMOTE Ⓡ jack of the CD player.

## Optical Out / Line Out (not on all models)

- 1 Connect the set to an **external** power source.
- 2 Turn down the volume of your stereo system.
- 3 Connect the (optical) signal lead (supplied or optionally available) to the OPTICAL OUT / LINE OUT socket of the CD player and to the DIGITAL IN (OPTICAL) / AUX socket of the other set (amplifier, digital cassette deck etc.).

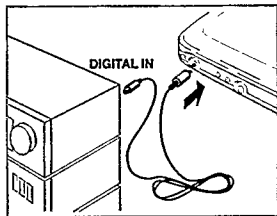

- 4 Adjust the sound with the controls of the stereo system.

*Note: A connection at OPTICAL OUT deactivates ESA/PSM.*

→ *Display indication: LINE*

# CONNECTIONS

English

## Connections for in-car use (supplied or optionally available)

AY 3545 - car voltage converter (4.5 V/600 mA, DC, positive pole to the center pin)

AY 3501 - car adapter cassette

- 1 Find a safe place for the CD player on a horizontal, vibration-free and stable surface where it is no danger to or in the way of the driver or passengers.
- 2 Connect the DC plug of the voltage converter to the DC socket of your CD player

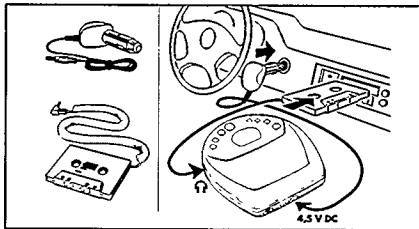

- (only for a 12 V car battery, negative grounding).**
- 3 Insert the voltage converter into the cigarette lighter socket. If necessary, clean the cigarette lighter socket to obtain a good electrical contact.
  - 4 Turn down the volume and **switch off the autoreverse function of your car radio cassette player.**
  - 5 Connect the adapter cassette plug to the LINE OUT/ REMOTE socket of the CD player.
  - 6 Insert the adapter cassette carefully into the car radio's cassette compartment.
  - 7 Make sure that the cord does not hinder your driving.
  - 8 Start the CD player, turn its volume to position 8 and adjust the sound with the car radio controls.

To remove the adapter cassette press the eject button of the car radio.

Always remove the voltage converter from the cigarette lighter socket when the CD player is not in use.

### Notes on in-car use:

- Avoid excessive heat from the car heating or from direct sunlight (e.g., in a parked car in the summer).
- If your car radio has a LINE IN jack, it is best to use it for the car radio connection instead of the adapter cassette. Connect the signal lead to this LINE IN jack and the LINE OUT/REMOTE socket of the CD player.

# OPERATION

English

## Inserting the CD

- Push gently on the CD center so that it fits onto the hub.

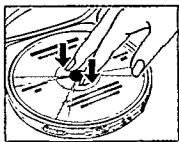

## Removing the CD

- Hold the CD by its edge and press the hub gently.

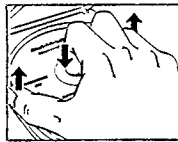

## Playing a CD

- 1 Open the lid by pushing the OPEN slide control to the side.

- 2 Insert an audio CD, printed side up. Push down on the left-hand side to close the lid.

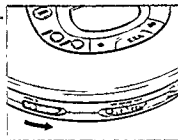

- 3 Press the ►|| button to start CD play.

→ Display indication: (example)

1 = current track / 2:56 = elapsed time of current track

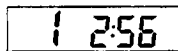

- 4 Adjust the sound using the VOLUME and DBB controls.

- 5 Interrupt CD play by pressing the ►|| button. Continue CD play by pressing the ►|| button again.

→ Display indication: time of the current position (flashing).

- 6 Press the STOP ■ button to stop CD play.

→ Display indication: (example)

17 = total number of tracks / 51:06 = total playing time

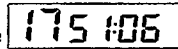

If you press the STOP ■ button again, you will switch off the set.

*Notes: -If no button is pressed for 10 seconds, the set will switch off automatically.*

*-Playing a CD-Rewriteable starts with a slight delay.*



# OPERATION

English

## MODE ○ – different playing modes

By pressing the MODE ○ button, you can successively activate the playing modes:

**SHUFFLE:** The tracks are played *in random order* until all of them have been played once.

**SHUFFLE REPEAT ALL:** All tracks are played *repeatedly in random order* until you leave this mode.

**REPEAT:** The track is played *repeatedly* until you leave this mode.

**REPEAT ALL:** The CD is played *repeatedly* until you leave this mode.

**SCAN:** Each track is scanned for 10 seconds until you leave this mode or all tracks have been played once.

Press the MODE ○ button again to deactivate all modes.

- ➔ The selected playing mode is indicated in the display.
- ➔ During play: CD play continues automatically with the selected playing mode.
- ➔ In stop position: press the ►|| button to start CD play.

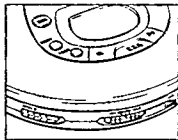

# OPERATION

English

## PROG P – programming of tracks (max. 99 tracks)

- 1 Select the desired track with PREV ◀◀ or NEXT ▶▶.
- 2 As soon as the desired track is displayed, press the PROG button to store the track in the memory.
  - Display indication: track number / P / total number of stored tracks, e.g.

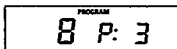

*Note:*

- When you press PROG and there is no track selected, the display indicates *SELECT*.

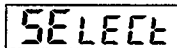

### Playing the program:

If you have selected the tracks in STOP mode, press the PLAY/PAUSE ▶|| button.

If you have selected the tracks during CD play, first press STOP ■ and then the PLAY/PAUSE ▶|| button.

- Display indication: PROGRAM.
- Your program will be played in the selected playing mode (e.g. SHUFFLE).

### Reviewing the settings:

Press the PROG button for more than 2 seconds.

- Display indication: each stored track successively flashes for a short moment.

### Erasing the program in STOP mode:

Press the STOP ■ button to erase the program.

- PROGRAM disappears on the display and your program is erased.
- *ERROR* lights up briefly on the display.

*Note: Interrupting the power supply or opening the lid will erase the program.*

# OPERATION

English

## ESA – Electronic Shock Absorption Memory PSM – Power Save Mode

Press the ESA button repeatedly to switch to ESA→PSM→off.

- The ESA/PSM symbol lights up in the display.
- The ESA memory continuously stores in advance the CD data to be played. This is to prevent sound skipping during play due to shock and vibration.
- Prolonged shocks and vibrations may empty the ESA memory completely and CD play will be interrupted.

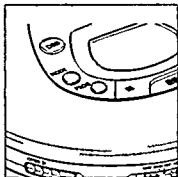

*Note: When switching the ESA and PSM feature on and off, CD play will be delayed or interrupted for a short time.*

## RESUME / HOLD

### RESUME – playing from where you have stopped

- 1 Activate the RESUME feature by sliding the RESUME/HOLD switch to the center setting.
- 2 If you stop CD play by pressing the STOP ■ button, the last position played will be stored.
- 3 Press ►|| to resume CD play from the position it was stopped at.

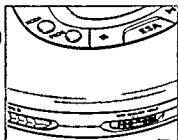

### HOLD – deactivating all buttons

Activate the HOLD feature by sliding the RESUME/HOLD switch to the far right.

- Now all buttons are locked until you switch the feature off again. If you press a button (except OPEN), the display will indicate HOLD.

*Note: - In the HOLD position, the RESUME function is automatically activated.  
- Opening the lid erases the information about the position played last.*



# GENERAL INFORMATION

English

- Do not touch the lens (X) of the CD player!
- Do not expose the CD player, batteries or CDs to rain and dampness, sand and dust or to excessive heat caused by heating equipment, or to direct sunlight.

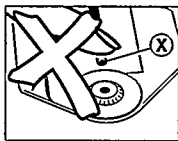

- The lens may cloud over when the set is suddenly moved from cold to warm surroundings. Playing a CD is not possible then. Leave the CD player in a warm environment until the moisture evaporates.
- You can clean the CD player with a soft and slightly dampened chamois leather. Do not use any cleaning agents as they may have a corrosive effect.

- Always pick up the CD by the edge and put it back in its box after use.



- To clean the CD, wipe it off in a straight line from the center towards the edge using a soft, lint-free cloth. A cleaning agent may damage the disc!

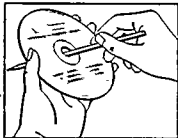

- When a new CD does not stay on the hub remove the small burrs around the center hole with a pen or similar instrument.
- Active mobile phones in the vicinity of the CD player may cause malfunctions.

## Environmental information

- Please observe the local regulations regarding the disposal of packing materials, exhausted batteries and obsolete equipment.
- All redundant packaging material has been omitted. We have done our utmost to make the packaging easily separable into three mono-materials: cardboard (box), expandable polystyrene (buffer), and polyethylene (bags, protective foam sheet).
- Your set consists of materials which can be recycled if disassembled by a specialized company.

# TROUBLESHOOTING

English

If a fault occurs, please check the points listed below before taking your set for repair.

If you are not able to remedy a problem by following these hints, consult your dealer or service facility.

| <b>PROBLEM</b>   | <b>POSSIBLE CAUSE</b>  | <b>SOLUTION</b>  |
|--|--|--|
| <b>No power or no CD play start</b>                                    | <b>Batteries</b>   |  |
|  | Batteries inserted incorrectly                                 | Insert the batteries correctly                                 |
| <b>Display: no indication</b>  | Use of new batteries   | Press ►II  |
|  | Batteries are empty  | Change/recharge the batteries                                  |
|  | Contact pins are dirty   | Clean them with a cloth  |
|  | <b>Mains adapter</b>   |  |
| <b>CD play does not start or is interrupted</b>                        | Loose connection   | Connect the adapter securely                                   |
|  | <b>In-car use</b>  |  |
|  | Cigarette lighter is not powered when ignition is switched off | Switch on ignition or insert batteries                         |
| <b>CD play does not start or is interrupted</b>                        | <b><i>HOLD feature is activated</i></b>                        | <b><i>Switch off the HOLD feature</i></b>                      |
|  | CD lid is not closed securely                                  | Close the lid securely   |
|  | Moisture condensation  | Leave the player in a warm place until the moisture evaporates |
| <b>Display: no indication or no disc</b>                               | CD is not or incorrectly inserted                              | Insert a CD, label facing up                                   |
|  | CD is badly scratched  | Use another CD   |
|  | CD is dirty  | Clean the CD   |
| <b>Battery recharging on board does not work, no CHARGE indication</b> | Use of wrong batteries   | Only a battery pack can be recharged on board                  |
|  | Contacts are dirty   | Clean them with a cloth  |
| <b>Play does not start from the first track</b>                        | RESUME or SHUFFLE or PROGRAM is activated                      | Switch off RESUME, SHUFFLE or PROGRAM                          |

# TROUBLESHOOTING

Under no circumstances should you try to repair the unit yourself, as this will invalidate the warranty.

English

| <b>PROBLEM</b>   | <b>POSSIBLE CAUSE</b>  | <b>SOLUTION</b>  |
|--|--|--|
| <b>General malfunction</b>   | Electrostatic discharge from the user via the CD player                | Disconnect the set from the power supply or take out the batteries for a few seconds |
| <b>No sound or bad sound quality</b>   | PAUSE is activated   | Press ►  |
|  | Loose or wrong connections   | Check connections  |
|  | Volume is not turned up  | Adjust the volume  |
|  | Headphones worn the wrong way  | Pay attention to the <b>L</b> (left) and <b>R</b> (right) indications                |
|  | Headphone plug is dirty  | Clean the headphone plug   |
|  | Strong magnetic fields near the CD player                              | Change the player's position or connections  |
|  | <b>In-car use</b>  |  |
| Strong vibrations  |  | Find another place for the set   |
| Adapter cassette is inserted incorrectly                                       |  | Insert the adapter cassette correctly  |
| Temperature inside car is too high/low   |  | Let the CD player adjust to the temperature  |
| Cigarette lighter/socket is too dirty  |  | Clean the cigarette lighter/socket   |
| Wrong playback direction of the autoreverse feature of the car cassette player |  | Change the autoreverse direction   |
| <b>Hum or noise in car</b>   | Unfit car radio input socket   | Use the adapter cassette   |
| <b>Malfunctions with remote control operation</b>                              | Remote control is not firmly connected to the LINE OUT/REMOTE Ⓞ socket | Check connections  |

# AUSTRALIA

## Philips product warranty for Australia

Warranty conditions valid for Colour Television, Video Cassette Recorders, Audio Systems, and Portable Audio.

The benefits given to the purchaser by this warranty are in addition to all other rights and remedies which the purchaser has in respect of the product under the Trade Practices Act or other Commonwealth or State Law.

Philips Sound and Vision warrants its products to the purchaser as follows and subject to the stated conditions.

### 12 months free service

Any defect in materials or workmanship in the product occurring within 12 months from the original date of purchase will be rectified free of charge by Philips Service or one of our authorised service centers.

### Conditions of warranty

1. All claims for warranty service should be made to your nearest Philips Service Branch or to a Philips authorised service dealer. Reasonable evidence of date of purchase must be provided.
2. This warranty extends only to defects occurring under normal use of the product when operated in accordance with the instructions.
3. Home service within the normal service area of Philips Service or one of our authorised service centres will be provided for television receivers with screen size 59cm and above. All other products are to be brought or sent to your nearest Philips Service Branch or to an authorised service centre.
4. This warranty does not cover:
  - a) Mileage or traveling time, pickup or delivery, cost of insurance.
  - b) Service costs arising from failure to correctly adjust the controls of the product or to observe the instructions, or inspections that reveal that the product is in normal working order.
  - c) Product failures caused by misuse, neglect, normal wear and tear, accidental breakage, transit damage, inexpert repairs or modification by unauthorised persons, lightning strikes, vermin infestation or liquid spillage.
  - d) Cleaning of video or audio heads.
  - e) Inadequate receiving antennae.
  - f) Replacement of worn or used batteries, styli or other consumables.

The conditions contained in this warranty replace and override the provisions of the World-Wide Guarantee for Products sold in Australia.

# AUSTRALIA

## Philips Service Branches

To contact your nearest Philips Service Branch call **13 13 92** from anywhere in Australia.

### Sydney

Technology Park  
Australia Centre  
3 Figtree Drive  
Homebush NSW 2140

### Newcastle & Central Coast

984 Hunter Street  
Newcastle West NSW 2302

### Perth

1 Fredrick Street  
Belmont WA 6104

### Melbourne

Cnr Wellington &  
Springvale Roads  
Mulgrave VIC 3170

### Brisbane

10 Graystone Street  
Tingalpa QLD 4173

### Also Service Centres:

#### Adelaide

348 Torrens Road  
Croydon Park SA 5008

#### Hobart

2A Pierce Street  
Moonah TAS 7009

#### Wollongong

1/216 Corrimal Street  
Wollongong NSW 2500

#### Canberra

Unit F,  
66-70 Maryborough Street  
Fyshwick ACT 2609

Service is also provided through 1,200 accredited service dealers throughout Australia. To find out about your nearest centre, call **13 13 92**.

## Call us direct on the Philips Customer Helpline

Philips customer care lasts as long as you keep the product. Whenever you need any information on the care or operation of your product, remember it's always best to go straight to the source. Phone Philips Helpline direct on

**13 13 91**  
**7 days a week**

— your call is always welcome.

Please record the following information for your records and keep in a safe place.

Model No:.....

Serial No:.....

***Please retain your purchase receipt which is required to claim  
service under warranty.***

Philips Electronics Australia Limited  
ACN 008 445 743, 3 Figtree Drive  
Homebush NSW 2140

# NEW ZEALAND

## Guarantee and Service for New Zealand

Thank-you for purchasing this quality Philips product.

Philips New Zealand Ltd guarantees this product against defective components and faulty workmanship for a period of 12 months. Any defect in materials or workmanship occurring within 12 months from the date of purchase subject to the following conditions will be rectified free of charge by the retailer from whom this product was purchased.

### Conditions

1. The product must have been purchased in New Zealand. As proof of purchase, retain the original sales docket indicating the date of purchase.
2. The guarantee applies only to faults caused by defective components, or faulty workmanship on the part of the manufacturer.
3. The guarantee does not cover failures caused by misuse, neglect, normal wear and tear, accidental breakage, use on the incorrect voltage, use contrary to operating instructions, or unauthorised modification to the product or repair by an unauthorised technician.
4. Reasonable evidence (in the form of a sales docket) must be supplied to indicate that the product was purchased no more than 12 months prior to the date of your claim.
5. In the event of a failure, Philips shall be under no liability for any injury, or any loss or damage caused to property or products other than the product under guarantee.

This guarantee does not prejudice your rights under common law and statute, and is in addition to the normal responsibilities of the retailer and Philips.

### How to claim

Should your Philips product fail within the guarantee period, please return it to the retailer from whom it was purchased. In most cases the retailer will be able to satisfactorily repair or replace the product.

However, should the retailer not be able to conclude the matter satisfactorily, or if you have other difficulties claiming under this guarantee, please contact

### The Guarantee Controller

Philips New Zealand Ltd.

✉ P.O. Box 41.021

Auckland

☎ (09) 84 94 160

fax ☎ (09) 84 97 858

---

**Meet Philips at the Internet**  
**<http://www.philips.com>**



**CLASS 1  
LASER PRODUCT**