

PHILIPS

AZ 7462 Portable Compact Disc Player
AZ7464
AZ7465

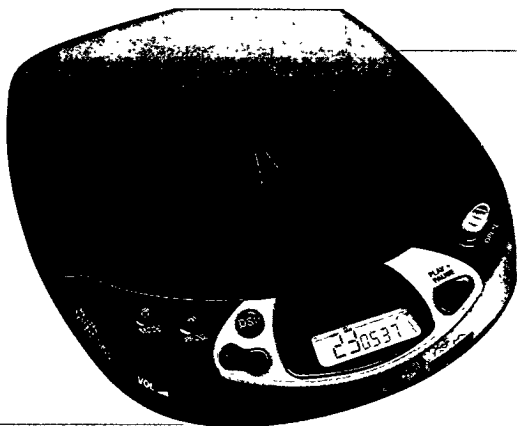

Instructions for use
Mode d'emploi
Instrucciones de manejo
使用説明書



PHILIPS

Australia

Guarantee and Service.....page 60

New Zealand

Guarantee and Service.....page 61

Mexico

Es necesario que lea cuidadosamente su instructivo de manejo.

VOH

Garantía.....pág. 62

English	Controls	4-5	Operation.....	10-14
	Accessories	6	General Information	15
	Power Supply.....	7	Troubleshooting.....	16-17
	Connections.....	8-9		

English

Français	Commandes.....	18-19	Fonctionnement.....	24-28
	Accessoires	20	Généralités	29
	Alimentation	21	Recherche de pannes...30-31	
	Branchements	22-23		

Français

Español	Mandos	32-33	Funcionamiento.....	38-42
	Accesorios	34	Información general	43
	Suministro de energía	35	Detección de anomalías	44-45
	Conexiones.....	36-37		

Español

中文	控制器	46-47	操作	52-56
	附件	48	一般說明	57
	電源供給	49	故障排除	58-59
	連接	50-51		

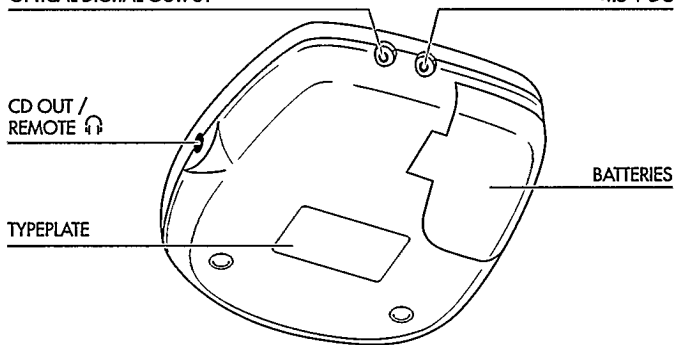
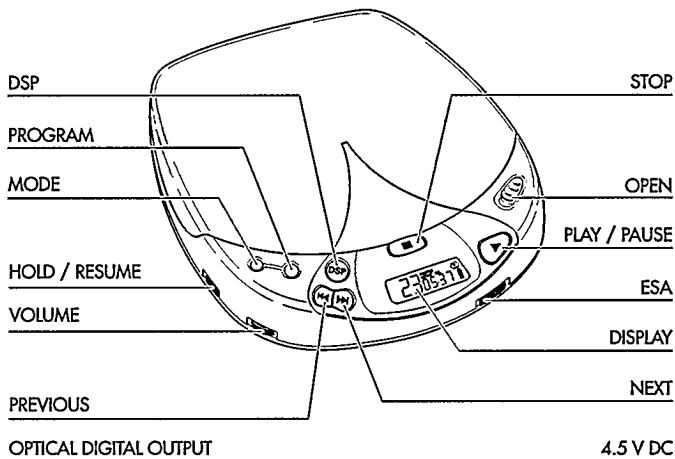

CONTROLS

- DISPLAY** Window for showing the different playing modes, tracks and times
- ▶▶** Button for selecting the next music track or, if held down, for searching forward for a particular passage on the CD
- ◀◀** Button for selecting the previous music track or, if held down, for searching-backward for a particular passage on the CD
- VOLUME** Control for adjusting the volume at the headphone output
- RESUME/HOLD** Switch for activating the RESUME function (resuming CD play) and/or HOLD (blocking all buttons) function
- MODE** ○ Button for selecting the different playing modes:
SHUFFLE→SHUFFLE REPEAT ALL→REPEAT 1→REPEAT ALL
→SCAN→off
- PROG** Button for storing tracks in a program and for reviewing the program
- DSP** **Digital Sound Processing:** Button for selecting the different sound settings at the headphone output:
ROCK→POP→CAR→INCREDIBLE SOUND→off
- STOP** ■ Button for stopping CD play, deleting various settings, switching off the CD player and activating charging.
- OPEN** Slide control for opening the lid of the CD player
- ▶||** Button for starting and pausing CD play
- ESA** **Electronic Shock Absorption:** Switch for activating the electronic buffer memory for an undisturbed sound
- CD OUT /**
- REMOTE** Ⓜ Headphone and remote control socket (3.5 mm)
- Digital out (optical)** For connecting the CD player to a Digital in (optical) socket in an amplifier or a digital recorder by means of an optical cable
- 4,5 V DC** Socket for external power supply
- Battery compartment** for inserting batteries

Note: In case of power supply via the DC jack (mains adapter or cigarette lighter in your car) the display is backlit. In battery mode, the illumination is activated for 10 seconds after key operations.

ACCESSORIES

Accessories

SBC 1059 - signal lead with 3.5 mm stereo plug and two cinch plugs.

Accessories for power supply

AY 3160 mains adapter 4.5 V/400 mA Direct current, plus-pole to the center pin

Note: Use only the PHILIPS AY 3160 adapter, other products may damage the set.

AY 3360 - NiMH battery pack for recharging on board (AZ 7465)

AY 3361 - NiCad battery pack for recharging on board

Remote controls

Cord remote control (AZ 7464)

LCD cord remote control (AZ 7465)

- The buttons on the cord remote control have the same functions as the corresponding ones on the CD player.

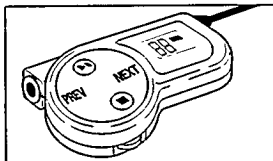

PLAY/PAUSE, PREVIOUS/NEXT, STOP: press on the indicated part of the switch

VOLUME: for reducing the main volume that has been adjusted with the volume control on the CD player

TECHNICAL DATA

Frequency range	20 - 20000 Hz
Signal-to-noise ratio	typ. 95 dBA
Channel separation	typ. 70 dBA
Total harmonic distortion	typ. 0.05 %
Conversion.....	Bitstream D/A Converter
Batteries.....	2 x 1.5 V, type AA / LR6 / UM3
Dimensions (w x h x d).....	134 x 30.5 x 154 mm
Weight (without/with batteries)	approx. 250/290 gms

POWER SUPPLY

Mains adapter

- 1 Make sure that the local voltage corresponds to the voltage of the adapter (see accessories).
 - 2 Connect the mains adapter to the player's 4.5 V DC socket and to the wall outlet.
- Always disconnect the adapter when you are not using it.

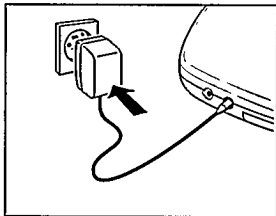

Batteries, type LR6, UM3 or AA (supplied or optional available)

- Open the battery compartment and insert the rechargeable battery pack or 2 alkaline batteries.

Typical playing times under normal conditions:
Alkaline batteries: 5.5 hours (ESA off)
4.5 hours (ESA on)

- Remove the batteries if they are empty or the CD player is not to be used for a long period of time.

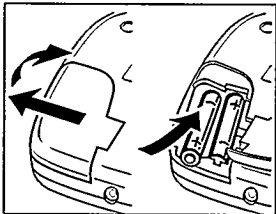

Note: In the right-hand corner of the display the battery condition will be indicated:

-Full batteries: no indication.

-Weak batteries:  -symbol lights up. This symbol is not available when rechargeable batteries are used.



*-Empty batteries:  -symbol flashes and the message *б R E E* appears. Replace the batteries or connect the mains adapter.*

Batteries contain chemical substances, therefore they should be disposed of properly.

CONNECTIONS

Recharging of Philips battery pack on board

The battery pack will be recharged if the mains adapter is connected, the set is switched off and you press the STOP ■ button.

- Display indication during charging: *CHARGE* and 
- Approx. charging time: 5.5 hours.
- Display indication if fully charged: *FULL* and 

Notes:

- *When using rechargeable batteries, we advise the use of the Philips battery pack only, as conventional separate Nickel-Cadmium batteries cannot be recharged on board.*
- *To ensure a long life for your battery pack, charging will automatically be interrupted at high ambient temperatures (Display indication: *HOT*).*

Connecting headphones (supplied)

- Connect the supplied headphones (16 ohms/3.5mm jack plug) with the CD OUT/REMOTE  jack.

Note : Use this jack also for connecting your HiFi system (signal lead) or your car radio (adapter cassette or signal lead). In both cases, the volume of the CD player has to be set to maximum position (10).

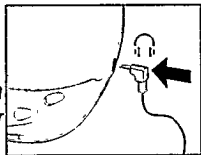

Use your head when using headphones

Hearing safety: Do not play your headphones at a high volume. Hearing experts advise that continuous use at high volume can permanently damage hearing.

Traffic safety: Do not use headphones while driving a vehicle. It may create a hazard and it is illegal in many countries. Even if your headphones are an open-air type designed to let you hear outside sounds, do not turn up the volume so high that you cannot hear what is going on around you.

Connecting the remote control

- 1 Switch off the CD player (press STOP ■ twice).
- 2 Connect the remote control *firmly* to the REMOTE ⤵ jack of the CD player.

Optical Digital Out (AZ 7465)

- 1 Connect the set to an external power source.
- 2 Turn down the volume of your stereo system.
- 3 Connect the optical signal lead (supplied or optional available) to the OPTICAL OUT socket of the CD player and to the DIGITAL IN (OPTICAL) socket of the other set (amplifier, digital cassette deck etc.).

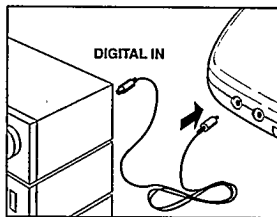

- 4 Adjust the sound with the controls of the stereo system.

Note: ESA has to be switched off when using the DIGITAL OUT socket.

OPERATION

Inserting the CD

- Push gently on the CD center so that it fits onto the hub.

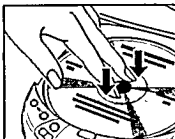

Removing the CD

- Hold the CD by its edge and press the hub gently.

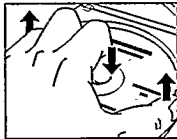

Playing a CD

- 1 Open the lid by pushing the OPEN slide control to the side.
- 2 Insert an audio CD, printed side up.
- 3 Close the lid by pushing down on the right-hand side.

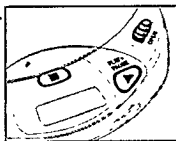

- Display indication of: (example)
17 = total number of tracks / 51:06 = total playing time

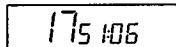

- 4 Press the ►|| button to start CD play.

- Display indication of: (example)
4 = current track / 2:56 = elapsed time of current track

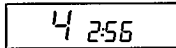

- 5 Adjust the sound using the controls VOLUME and DSP.
 - 6 You can interrupt CD play by pressing the ►|| button. Continue CD play by pressing the ►|| button again.
→ Display indication of: time of the current position (flashing).
 - 7 Press the STOP ■ button to stop CD play.
→ Display indication of: total number of tracks / the total playing time.
- If you press the STOP ■ button again, you will switch off the set.

Note: If no button is pressed for 90 seconds, the set will switch off automatically.



Selecting another track

- Briefly press the **⏮** or **⏭** button once/several times to skip to the beginning of the current/previous or next track(s).
 - Display indication of: selected track number.
 - During play: CD play continues automatically with the selected track.
 - In stop position: press the **▶||** button to start CD play.

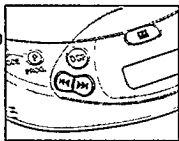

Searching for a passage during CD play

- 1 Hold down the **⏮** or **⏭** button to find a particular passage in forward or backward direction.
 - After 2 seconds, searching will start at high speed.
- 2 Release the button when you have reached the desired passage.

Note: Searching is only possible within the particular track when you are in one of these modes: SHUFFLE, REPEAT 1 or PROGRAM. Searching is not possible in the SCAN mode.

OPERATION

MODE ○ – different playing modes

- By pressing the MODE ○ button, you can successively activate the playing modes:

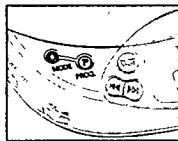

SHUFFLE: The tracks are played *in random order* until all of them have been played once.

SHUFFLE REPEAT ALL: All tracks are played *repeatedly in random order* until you leave this mode.

REPEAT 1: The track is played *repeatedly* until you leave this mode.

REPEAT ALL: The CD is played *repeatedly* until you leave this mode.

SCAN: Each track is scanned for 10 seconds until you leave this mode or all tracks have been played once.

- The selected playing mode is indicated in the display.
- During play: CD play continues automatically with the selected playing mode.
- In stop position: press the ►|| button to start CD play.

Notes:

- You can choose from 12 different playing modes when you combine all the above-mentioned modes with PROGRAM.
- Deactivate all modes with the MODE ○ button.

PROG – programming of tracks (max. 25 tracks)

- 1 Select the desired track with PREV ◀◀ or NEXT ▶▶.
- 2 As soon as the desired track is displayed, press the PROG button to store the track in the memory.

→ Display indication of: track number
/ P / total number of stored tracks, e.g.

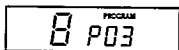

Notes:

- When you try to store more than 25 tracks, the display indicates *FULL*.
- When you press PROG and there is no track selected, the display indicates *SELECE*.

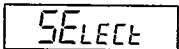
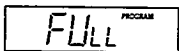

Playing the program:

- If you have selected the tracks in STOP mode, press the PLAY/PAUSE ▶|| button.
- If you have selected the tracks during CD play, first press STOP ■ and then the PLAY/PAUSE ▶|| button.
 - Display indication: PROGRAM.
 - Your program will be played in the selected playing mode (e.g. shuffle).

Reviewing the settings:

- Press the PROG button for more than 2 seconds.
 - Display indication: each stored track successively flashes for a short moment.

Erasing the program in STOP mode:

- Press the STOP ■ button to erase the program.
 - PROGRAM disappears on the display and your program is erased.
 - *ERROR* lights up briefly on the display.

Note: Interrupting the power supply or opening the lid will also erase the program.

OPERATION

ESA – Electronic Shock Absorption Memory

- Activate the ESA memory by sliding the ESA switch to the right.
 - The ESA symbol lights up in the display.
 - The ESA memory continuously stores in advance the CD data to be played. This is to prevent sound skipping during play due to shock and vibration.
 - Prolonged shocks and vibrations may empty the ESA memory completely. Then the display shows *SERR* and there will be no sound.

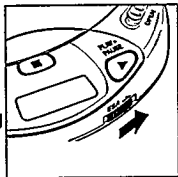

Note: When switching the ESA feature on and off, CD play will be delayed or interrupted for a short time.

RESUME / HOLD

RESUME – playing from where you have stopped

- Activate the RESUME feature by sliding the RESUME/HOLD switch to the middle.
- If you stop CD play by pressing the STOP ■ button, the last played position will be stored.
- Press ►|| to resume CD play from the position where it was stopped.

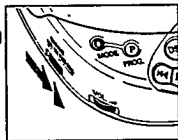

HOLD – deactivating all buttons

- Activate the HOLD feature by sliding the RESUME/HOLD switch to the far right.
 - Now all buttons are deactivated and will not function until you switch the feature off again. If you press a button (except OPEN), the display will indicate HOLD.

Notes:

-In the hold position, the resume function is automatically activated.

-Do not open the lid as this erases the information about the last position played.

GENERAL INFORMATION

Maintenance

- The lens (⊗) of the CD player should never be touched!
- Do not expose the CD player, batteries or CDs to rain and dampness, sand and dust or to excessive heat caused by heating equipment, or to direct sunlight.
- The lens may cloud over when the set is suddenly moved from cold to warm surroundings. Playing a CD is not possible then. Leave the CD player in a warm environment until the moisture evaporates.
- You can clean the CD player with a soft and slightly dampened chamois leather. Do not use any cleaning agents as they may have a corrosive effect.
- Always pick up the CD by the edge and put it back in its box after use.
- To clean the CD, wipe it off in a straight line from the center towards the edge using a soft, lint-free cloth. A cleaning agent may damage the disc!
- When a new CD does not stay on the hub, this is caused by small burrs around the center hole of the CD. Remove the burrs by rubbing the edge of the center hole with a pen or similar instrument.

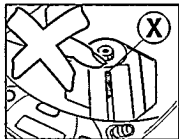

Environmental information

Please observe the local regulations regarding the disposal of packing materials, exhausted batteries and obsolete equipment.

- All redundant packaging material has been omitted. We have done our utmost to make the packaging easily separable into three mono-materials: cardboard (box), expandable polystyrene (buffer), and polyethylene (bags, protective foam sheet).
- Your set consists of materials which can be recycled if disassembled by a specialized company.
- Do not dispose of exhausted batteries with your household waste.

TROUBLESHOOTING

- If a fault occurs, please check the points listed below before taking your set for repair.
- If you are not able to remedy a problem by following these hints, consult your dealer or service facility.

PROBLEM	POSSIBLE CAUSE	REMEDY
No power or no CD play start	Batteries	
	Batteries incorrectly inserted	Insert the batteries correctly
Display: no indication	Use of new batteries	Press ►II
	Batteries are empty	Change/recharge the batteries
	Contact pins are dirty	Clean them with a cloth
	mains adapter	
CD play does not start or interrupts	Loose connection	Connect the adapter securely
	In-car use	
	Cigarette lighter is not powered when ignition is switched off	Switch on ignition or insert batteries
CD play does not start or interrupts	<i>HOLD feature is activated</i>	<i>Switch off the HOLD feature</i>
	CD lid is not closed securely	Close the lid securely
	Moisture condensation	Leave the player in a warm place until the moisture evaporates
Display: no indication or no disc	CD is not or incorrectly inserted	Insert a CD, label facing up
	CD is badly scratched	Use another CD
	CD is dirty	Clean the CD
Battery-recharging on board does not work, no CHARGE-indication	Use of wrong batteries	Only a battery pack can be recharged on board
	Contacts are dirty	Clean them with a cloth
Play does not start from the first track	RESUME or SHUFFLE or PROGRAM is activated	Switch off RESUME, SHUFFLE or PROGRAM

TROUBLESHOOTING

Under no circumstances should you try to repair the unit yourself, as this will invalidate the warranty.

English

PROBLEM	POSSIBLE CAUSE	REMEDY
No sound or bad sound quality	PAUSE is activated	Press ►
	Loose or wrong connections	Check connections
	Volume is not turned up	Adjust the volume
	Headphones worn the wrong way	Pay attention to the L (left) and R (right) indications
	Headphone plug is dirty	Clean the headphone plug
	Strong magnetic fields near the CD player	Change the player's position or connections
	Electrostatic discharge from the user via the CD player	Press ◀◀ or ▶▶ once or press ► twice
	In-car use	
	Strong vibrations	Find another place for the set
	Adapter cassette is incorrectly inserted	Insert the adapter cassette correctly
Temperature inside car is too high/low	Let the CD player adjust to the temperature	
Cigarette lighter/socket is too dirty	Clean the cigarette lighter/socket	
Wrong playback direction of the autoreverse feature of the car cassette player	Change the autoreverse direction	
Hum or noise in-car	Unfit car radio input socket	Use the adapter cassette
Malfunctions with remote control operation	Remote control is not firmly connected to the CD OUT/REMOTE ↻ socket	Check connections

AUSTRALIA

Guarantee and Service valid for Australia

The benefits given to the purchaser by this warranty are in addition to all other rights and remedies, which, under the Trade Practices Act or other Commonwealth or State law, the purchaser or owner has in respect of the product.

The Philips product carries the following warranties:

- C-series HiFi-systems 12 months.
- Compact Disc Players: 12 months.
- Home Audio Systems: 6 months.
- Clock radios, portable radios, cassette recorders, cassette players and radio recorders: 90 days.

Any defect in materials or workmanship occurring within the specified period from the date of delivery, will be rectified free of charge by the retailer from whom this product was purchased.

Note: Please retain your purchase docket to assist prompt service.

Conditions of this warranty

1. All claims for warranty service must be made to the retailer from whom this product was purchased. All transport charges incurred in connection with warranty service or replacement will be paid by the purchaser.
2. These warranties do not cover batteries and extend only to defects in materials or workmanship occurring under normal use of the product where operated in accordance with our instructions.

**Philips Consumer Products Division
Technology Park
Figtree Drive, Australia Centre
Homebush 2140
New South Wales**

Guarantee and Service for New Zealand

Thank-you for purchasing this quality Philips product.

Philips New Zealand Ltd guarantees this product against defective components and faulty workmanship for a period of 12 months. Any defect in materials or workmanship occurring within 12 months from the date of purchase subject to the following conditions will be rectified free of charge by the retailer from whom this product was purchased.

Conditions

1. The product must have been purchased in New Zealand. As proof of purchase, retain the original sales docket indicating the date of purchase.
2. The guarantee applies only to faults caused by defective components, or faulty workmanship on the part of the manufacturer.
3. The guarantee does not cover failures caused by misuse, neglect, normal wear and tear, accidental breakage, use on the incorrect voltage, use contrary to operating instructions, or unauthorised modification to the product or repair by an unauthorised technician.
4. Reasonable evidence (in the form of a sales docket) must be supplied to indicate that the product was purchased no more than 12 months prior to the date of your claim.
5. In the event of a failure, Philips shall be under no liability for any injury, or any loss or damage caused to property or products other than the product under guarantee.

This guarantee does not prejudice your rights under common law and statute, and is in addition to the normal responsibilities of the retailer and Philips.

How to claim

Should your Philips product fail within the guarantee period, please return it to the retailer from whom it was purchased. In most cases the retailer will be able to satisfactorily repair or replace the product.

However, should the retailer not be able to conclude the matter satisfactorily, or if you have other difficulties claiming under this guarantee, please contact

The Guarantee Controller

Philips New Zealand Ltd.

✉ P.O. Box 41.021

Auckland

☎ (09) 84 94 160

fax ☎ (09) 84 97 858

Garantía para México

Este aparato está fabricado con materiales de alta calidad y ha sido cuidadosamente verificado. Philips, por lo tanto, da a usted una garantía de 12 meses a partir de su fecha de compra.

La garantía ampara la reposición de las piezas defectuosas debidas a fallas en su montaje o en los materiales, incluyendo la mano de obra necesaria para su reemplazo en nuestras Sucursales o talleres autorizados.

En caso de fallas en su aparato le rogamos se sirva poner en contacto con su distribuidor.

Esta garantía no cubrirá las averías que resulten como consecuencia de una instalación incorrecta del aparato, manifiesto maltrato o uso inadecuado del mismo.

Philips se obliga a reparar y devolver a usted su aparato en un plazo no mayor de 30 días hábiles contados a partir de la fecha de haber ingresado su aparato a uno de nuestros talleres.

Para que esta garantía sea válida, es necesario que el certificado que figura en la parte posterior de esté instructivo haya sido debidamente llenado en el momento de la compra del aparato.

En caso de extravío del certificado con la presentación de la factura o remisión de su aparato podrá hacer efectiva la garantía correspondiente.

Si usted tiene alguna duda o pregunta que no le pueda solucionar su distribuidor, por favor ponerse en contacto con:

**Oficinas Centrales de Servicio,
Av. Coyoacán No. 1051,
Col. del Valle,
03100 México, D.F.
☎ 5-75-20-22 o 5-75-01-00**

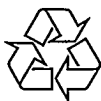

**CLASS 1
LASER PRODUCT**