

# PHILIPS

AZ 7262 Portable Compact Disc Player

AZ 7267

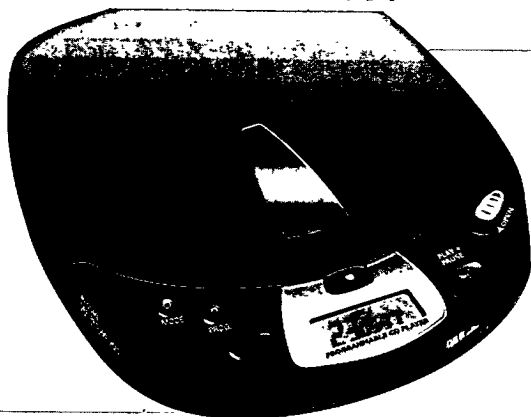

Instructions for Use  
Mode d'emploi  
Instrucciones de manejo  
Bedienungsanleitung  
Gebruiksaanwijzing  
Istruzioni per l'uso  
Bruksanvisning  
Brugsanvisning  
Käyttöohje  
Manual de utilização  
Οδηγίες χρήσεως



**PHILIPS**

**English**

<b>English</b>	Controls .....6	Operation .....11-15
	Accessories .....7	General information.16-17
	Power Supply .....8	Troubleshooting .....18-19
	Connections .....9-10	

**Français**

<b>Français</b>	Commandes .....20	Fonctionnement .....25-29
	Accessoires .....21	Généralités .....30-31
	Alimentation.....22	Recherche des
	Branchements .....23-24	pannes .....32-33

**Español**

<b>Español</b>	Mandos .....34	Funcionamiento.....39-43
	Accesorios.....35	Información general.44-45
	Alimentación .....36	Detección de
	Conexiones.....37-38	anomalías.....46-47

**Deutsch**

<b>Deutsch</b>	Bedienungselemente ....48	Bedienung .....53-57
	Zubehör .....49	Allg. Informationen ..58-59
	Stromversorgung.....50	Fehlersuche.....60-61
	Anschlüsse.....51-52	

**Nederlands**

<b>Nederlands</b>	Bedieningstoetsen .....62	Bediening .....67-71
	Accessoires .....63	Algemene informatie 72-73
	Voeding.....64	Problemen
	Aansluitingen.....65-66	oplossen.....74-75

**Italiano**

<b>Italiano</b>	Comandi .....76	Funzionamento .....81-85
	Accessori .....77	Informazioni generali 86-87
	Alimentazione .....78	Ricerca guasti .....88-89
	Collegamenti.....79-80	

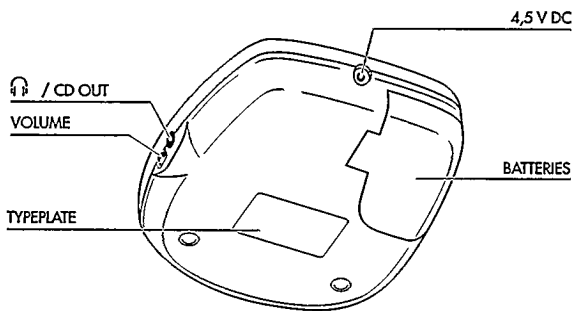
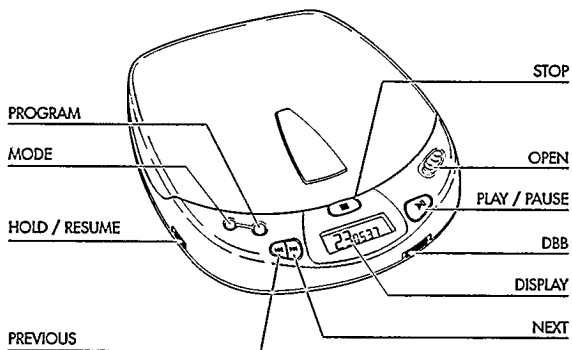

## **Deutschland**

Hiermit wird bescheinigt, daß dieses Gerät in Übereinstimmung mit den Bestimmungen der Amtsblattverfügung 1046/1984 funktentstört ist.

Der Deutschen Bundespost wurde das Inverkehrbringen dieses Gerätes angezeigt und die Berechtigung zur Überprüfung der Serie auf Einhaltung der Bestimmungen eingeräumt.

## **Norge**

Typeskilt finnes på apparatens underside.

<b>Svenska</b>	Reglage .....90	Bruksanvisning.....95-99
	Tillbehör.....91	Allmänna
	Strömförsörjning .....92	upplysningar.....100-101
	Anslutningar.....93-94	Felsökning .....102-103

**Svenska**

<b>Dansk</b>	Betjeningsknapper .....104	Anvendelse .....109-113
	Tilbehør.....105	Generel information114-115
	Strømforsyning.....106	Fejlfinding .....116-117
	Tilslutninger .....107-108	

**Dansk**

<b>Suomi</b>	Käyttöpainikkeet .....118	Käyttö.....123-127
	Tarvikkeet .....119	Yleistä .....128-129
	Virransyöttö.....120	Tarkistusluettelo ..130-131
	Kytkenät .....121-122	

**Suomi**

<b>Português</b>	Comandos.....132	Funcionamento.....137-141
	Acessórios.....133	Informações gerais142-143
	Alimentação .....134	Avarias .....144-145
	Ligações .....135-136	

**Português**

<b>Έλληνικά</b>	Χειριστήρια.....146	Γενικές
	Εξαρτήματα.....147	πληροφορίες .....156-157
	Τροφοδοσία .....148	Διόρθωση
	Συνδέσεις .....149-150	βλαβών .....158-159
	Λειτουργία.....151-155	

**Έλληνικά**

# CONTROLS

please refer to the illustration on page 3

English

- DISPLAY** ..... Window for showing the different playing modes, tracks and times
- ▶▶** ..... Button for selecting the next music track or, if held down, for searching forward for a particular passage on the CD
- ◀◀** ..... Button for selecting the previous music track or, if held down, for searching-backward for a particular passage on the CD
- VOLUME** ..... Control for adjusting the volume at the headphone output
- RESUME/HOLD** ..... Switch for activating the RESUME function (resuming CD play) and/or HOLD (blocking all buttons) function
- MODE** ○ ..... Button for selecting the different playing modes:  
SHUFFLE→SHUFFLE REPEAT ALL→REPEAT 1→REPEAT ALL  
→SCAN→off
- PROG P** ..... Button for storing tracks in a program and for reviewing the program
- DBB** ..... **Dynamic Bass Boost**: Button for boosting the bass response
- STOP** ■ ..... Button for stopping CD play, deleting various settings, switching off the CD player and activating charging.
- OPEN** ..... Slide control for opening the lid of the CD player
- ▶||** ..... Button for starting and pausing CD play
- 🔌 / CD OUT** ..... Headphone and remote control socket (3.5 mm)
- 4.5 V DC** ..... Socket for external power supply
- Battery compartment** for inserting batteries

*This set complies with the radio interference requirements of the European Community.*

# ACCESSORIES

## Accessories

*(supplied or optional available from your dealer or Philips Service Center)*

English

*Note: Please ask your dealer for detailed information since not all accessories may be available in your country.*

SBC 1059 - signal lead with 3.5 mm stereo plug and two cinch plugs.

### **Accessories for power supply**

AY 3160 mains adapter 4.5 V/400 mA Direct current, plus-pole to the center pin

*Note: Use only the AY 3160 adapter, other products may damage the set.*

AY 3361 - NiCad battery pack for recharging on board

# POWER SUPPLY

English

## Mains adapter (supplied or optional available)

- 1 Make sure that the local voltage corresponds to the voltage of the adapter (see accessories).
  - 2 Connect the mains adapter to the player's 4.5 V DC socket and to the wall outlet.
- Always disconnect the adapter when you are not using it.

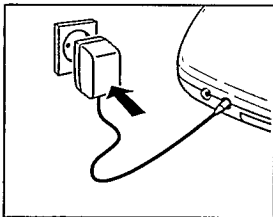

## Batteries, type LR6, UM3 or AA (supplied or optional available)

- Open the battery compartment and insert the rechargeable battery pack or 2 alkaline batteries.

Typical playing times under normal conditions:  
Alkaline batteries: 6 hours

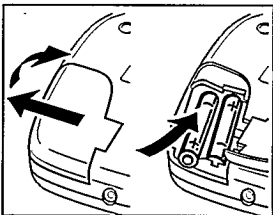

- Remove the batteries if they are empty or the CD player is not to be used for a long time.



*Note: In the right-hand corner of the display the battery condition will be indicated:*

*-Full batteries: no indication.*

*-Weak batteries:  -symbol lights up.*

*-Empty batteries:  -symbol flashes and the message  appears. Replace or recharge the batteries or connect the mains adapter.*

**Batteries contain chemical substances, therefore they should be disposed of properly.**



# CONNECTIONS

English

## Connecting headphones (supplied)

- Connect the supplied headphones (16 ohms/ 3.5mm jack plug) with the  / CD OUT jack.

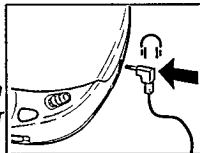

*Note : Use this jack also for connecting your HiFi system (signal lead) or your car radio (adapter cassette or signal lead). In both cases, the volume of the CD player has to be set to position 6-8.*



## Use your head when using headphones

**Hearing safety:** Do not play your headphones at a high volume. Hearing experts advise that continuous use at high volume can permanently damage hearing.

**Traffic safety:** Do not use headphones while driving a vehicle. It may create a hazard and it is illegal in many countries. Even if your headphones are an open-air type designed to let you hear outside sounds, do not turn up the volume so high that you cannot hear what is going on around you.

## Recharging of Philips battery pack on board *(supplied or optional available)*

The battery pack will be recharged if the mains adapter is connected, the set is switched off and you press the STOP ■ button.

- Display indication during charging: *CHARGE* and 
- Approx. charging time: 7 hours.
- Display indication if fully charged: *FULL* and 

### *Notes:*

- *When using rechargeable batteries, we advise the use of the Philips battery pack only, as conventional separate Nickel-Cadmium batteries cannot be recharged on board.*
- *To ensure a long life for your battery pack, charging will automatically be interrupted at high ambient temperatures (Display indication: *HOT*).*

# OPERATION

English

## Inserting the CD

- Push gently on the CD center so that it fits onto the hub.

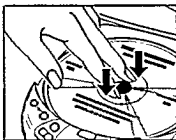

## Removing the CD

- Hold the CD by its edge and press the hub gently.

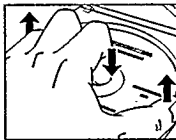

## Playing a CD

- 1 Open the lid by pushing the OPEN slide control to the side.

- 2 Insert an audio CD, printed side up.

- 3 Close the lid by pushing down on the right-hand side.

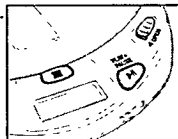

- Display indication of: (example)

17 = total number of tracks / 51:06 = total playing time

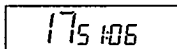

- 4 Press the ►|| button to start CD play.

- Display indication of: (example)

4 = current track / 2:56 = elapsed time of current track

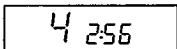

- 5 Adjust the sound using the controls VOLUME and DBB.

- 6 You can interrupt CD play by pressing the ►|| button. Continue CD play by pressing the ►|| button again.

- Display indication of: time of the current position (flashing).

- 7 Press the STOP ■ button to stop CD play.

- Display indication of: total number of tracks / the total playing time.

- If you press the STOP ■ button again, you will switch off the set.

*Note: If no button is pressed for 90 seconds, the set will switch off automatically.*

# OPERATION



## Selecting another track

- Briefly press the **◀◀** or **▶▶** button once/several times to skip to the beginning of the current/previous or next track(s).
  - Display indication of: selected track number.
  - During play: CD play continues automatically with the selected track.
  - In stop position: press the **▶||** button to start CD play.

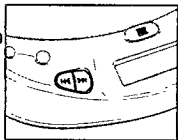

## Searching for a passage during CD play

- 1 Hold down the **◀◀** or **▶▶** button to find a particular passage in forward or backward direction.
  - After 2 seconds, searching will start at high speed.
- 2 Release the button when you have reached the desired passage.

*Note: Searching is only possible within the particular track when you are in one of these modes: SHUFFLE, REPEAT 1 or PROGRAM. Searching is not possible in the SCAN mode.*

## MODE ○ – different playing modes

- By pressing the MODE ○ button, you can successively activate the playing modes:

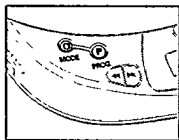

SHUFFLE: The tracks are played **in random order** until all of them have been played once.

SHUFFLE REPEAT ALL: All tracks are played **repeatedly in random order** until you leave this mode.

REPEAT 1: The track is played **repeatedly** until you leave this mode.

REPEAT ALL: The CD is played **repeatedly** until you leave this mode.

SCAN: Each track is scanned for 10 seconds until you leave this mode or all tracks have been played once.

- The selected playing mode is indicated in the display.
- During play: CD play continues automatically with the selected playing mode.
- In stop position: press the ►|| button to start CD play.

### Notes:

- You can choose from 12 different playing modes when you combine all the above-mentioned modes with PROGRAM.
- Deactivate all modes with the MODE ○ button.

# OPERATION

## PROG – programming of tracks (max. 15 tracks)

- 1 Select the desired track with PREV ◀◀ or NEXT ▶▶.
- 2 As soon as the desired track is displayed, press the PROG button to store the track in the memory.

→ Display indication of: track number  
/ P / total number of stored tracks, e.g.

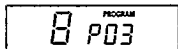

### Notes:

- When you try to store more than 15 tracks, the display indicates *FULL*.
- When you press PROG and there is no track selected, the display indicates *SELECT*.

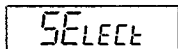
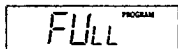

### Playing the program:

- If you have selected the tracks in STOP mode, press the PLAY/PAUSE ▶|| button.
- If you have selected the tracks during CD play, first press STOP ■ and then the PLAY/PAUSE ▶|| button.
  - Display indication: PROGRAM.
  - Your program will be played in the selected playing mode (e.g. shuffle).

### Reviewing the settings:

- Press the PROG button for more than 2 seconds.
  - Display indication: each stored track successively flashes for a short moment.

### Erasing the program in STOP mode:

- Press the STOP ■ button to erase the program.
  - PROGRAM disappears on the display and your program is erased.
  - CLEAR lights up briefly on the display.

*Note: Interrupting the power supply or opening the lid will also erase the program.*

## DBB - Dynamic Bass Boost

- Activate DBB by sliding the DBB switch to the right.

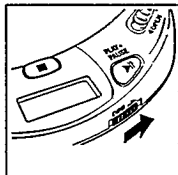

## RESUME / HOLD

### RESUME – playing from where you have stopped

- Activate the RESUME feature by sliding the RESUME/HOLD switch to the middle.
- If you stop CD play by pressing the STOP ■ button, the last played position will be stored.
- Press ►|| to resume CD play from the position where it was stopped.

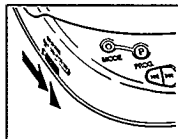

### HOLD – deactivating all buttons

- Activate the HOLD feature by sliding the RESUME/HOLD switch to the far right.
  - Now all buttons are deactivated and will not function until you switch the feature off again. If you press a button (except OPEN), the display will indicate HOLD.

### Notes:

- In the hold position, the resume function is automatically activated.
- Do not open the lid as this erases the information about the last position played.

# GENERAL INFORMATION

English

## Technical Data

Frequency range.....	20 - 20000 Hz
Signal-to-noise ratio .....	typ. 88 dBA
Total harmonic distortion .....	typ. 0.05 %
Conversion.....	Bitcheck Continuous Calibration
Batteries.....	2 x 1.5 V, type AA / LR6 / UM3
Dimensions (w x h x d).....	134 x 30.5 x 154 mm
Weight (without/with batteries) .....	approx. 250/290 gms



# GENERAL INFORMATION

## Maintenance

- The lens (X) of the CD player should never be touched!
- Do not expose the CD player, batteries or CDs to rain and dampness, sand and dust or to excessive heat caused by heating equipment, or to direct sunlight.
- The lens may cloud over when the set is suddenly moved from cold to warm surroundings. Playing a CD is not possible then. Leave the CD player in a warm environment until the moisture evaporates.
- You can clean the CD player with a soft and slightly dampened chamois leather. Do not use any cleaning agents as they may have a corrosive effect.
- Always pick up the CD by the edge and put it back in its box after use.
- To clean the CD, wipe it off in a straight line from the center towards the edge using a soft, lint-free cloth. A cleaning agent may damage the disc!
- When a new CD does not stay on the hub, this is caused by small burrs around the center hole of the CD. Remove the burrs by rubbing the edge of the center hole with a pen or similar instrument.

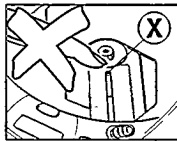

## Environmental information

- Please observe the local regulations regarding the disposal of packing materials, exhausted batteries and obsolete equipment.
- All redundant packaging material has been omitted. We have done our utmost to make the packaging easily separable into three mono-materials: cardboard (box), expandable polystyrene (buffer), and polyethylene (bags, protective foam sheet).
  - Your set consists of materials which can be recycled if disassembled by a specialized company.
  - Do not dispose of exhausted batteries with your household waste.

# TROUBLESHOOTING

- If a fault occurs, please check the points listed below before taking your set for repair.
- If you are not able to remedy a problem by following these hints, consult your dealer or service facility.

PROBLEM	POSSIBLE CAUSE	SOLUTION
No power or no CD play start	<b>Batteries</b>	
	Batteries incorrectly inserted	Insert the batteries correctly
Display: no indication	Use of new batteries	Press ►II
	Batteries are empty	Change/recharge the batteries
	Contact pins are dirty	Clean them with a cloth
	<b>mains adapter</b>	
	Loose connection	Connect the adapter securely
	<b>In car use</b>	
	Cigarette lighter is not powered when ignition is switched off	Switch on ignition or insert batteries
CD play does not start or interrupts	<b><i>HOLD feature is activated</i></b>	<b><i>Switch off the HOLD feature</i></b>
	CD lid is not closed securely	Close the lid securely
	Moisture condensation	Leave the player in a warm place until the moisture evaporates
Display: no indication or no disc	CD is not or incorrectly inserted	Insert a CD, label facing up
	CD is badly scratched	Use another CD
	CD is dirty	Clean the CD
Battery-recharging on board does not work, no CHARGE-indication	Use of wrong batteries	Only a battery pack can be recharged on board
	Contacts are dirty	Clean them with a cloth
Play does not start from the first track	RESUME or SHUFFLE or PROGRAM is activated	Switch off RESUME, SHUFFLE or PROGRAM

# TROUBLESHOOTING

Under no circumstances should you try to repair the unit yourself, as this will invalidate the warranty.

English

<b>PROBLEM</b>	<b>POSSIBLE CAUSE</b>	<b>SOLUTION</b>	
<b>No sound or bad sound quality</b>	PAUSE is activated	Press ►II	
	Loose or wrong connections	Check connections	
	Volume is not turned up	Adjust the volume	
	Headphones worn the wrong way	Pay attention to the L (left) and R (right) indications	
	Headphone plug is dirty	Clean the headphone plug	
	Strong magnetic fields near the CD player	Change the player's position or connections	
	Electrostatic discharge from the user via the CD player	Press ◀◀ or ▶▶ once or press ►II twice	
	<b>In car use</b>		
	Strong vibrations	Find another place for the set	
	Adapter cassette is incorrectly inserted	Insert the adapter cassette correctly	
Temperature inside car is too high/low	Let the CD player adjust to the temperature		
Cigarette lighter/socket is too dirty	Clean the cigarette lighter/socket		
Wrong playback direction of the autoreverse feature of the car cassette player	Change the autoreverse direction		
<b>Hum or noise in car</b>	Unfit car radio input socket	Use the adapter cassette	
<b>Malfunctions with remote control operation</b>	Remote control is not firmly connected to the ⚡ / CD OUT socket	Check connections	









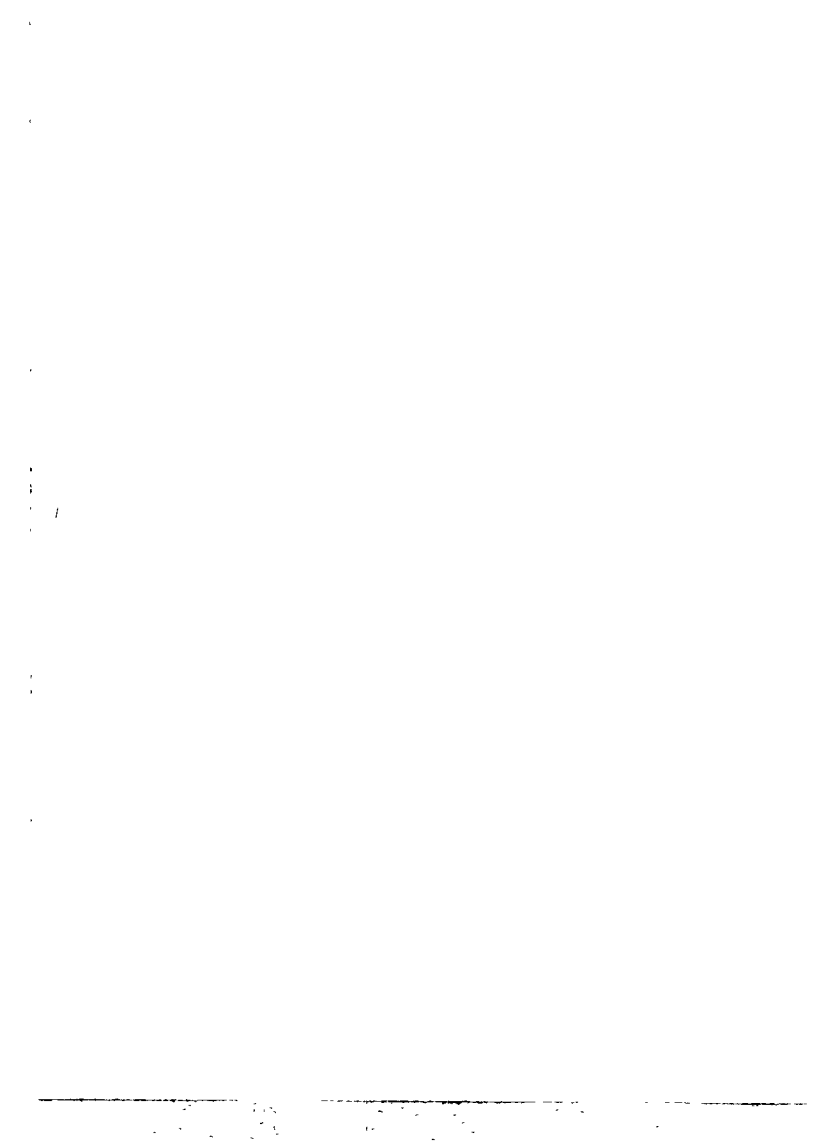



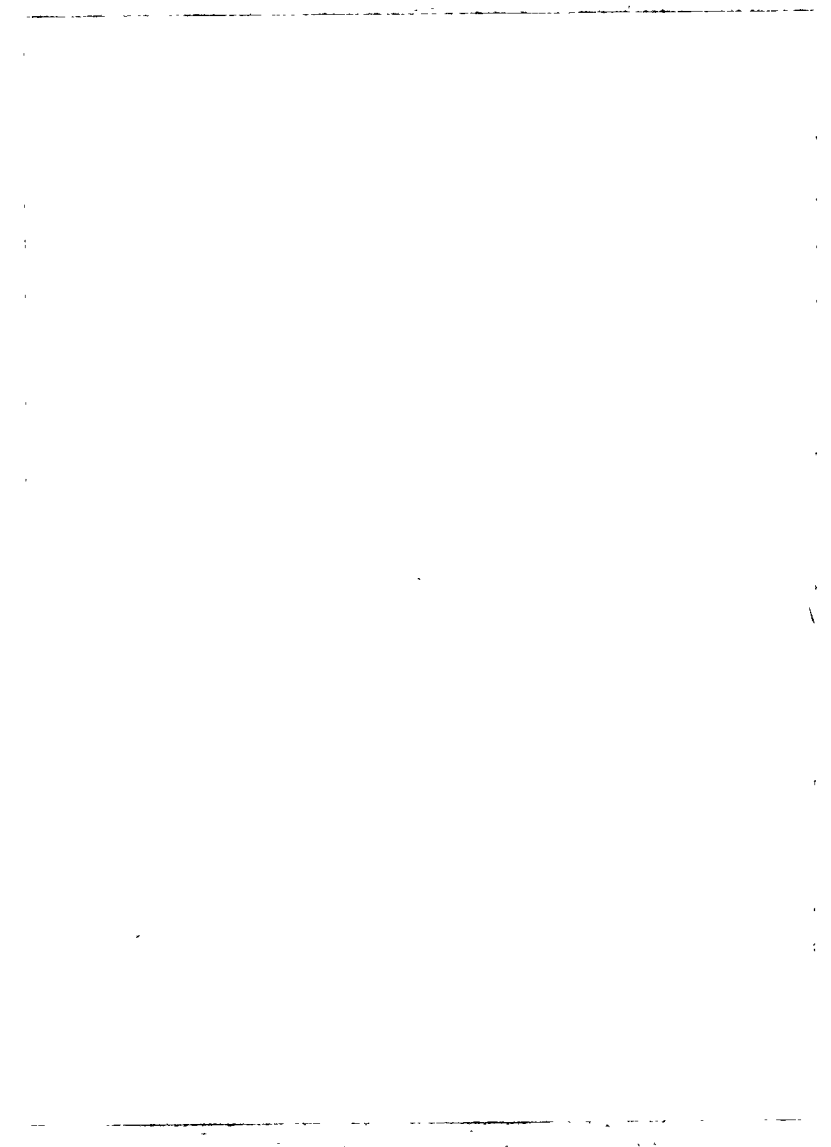

---

**CLASS 1  
LASER PRODUCT**

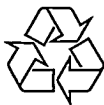

3103 306 15502

printed in Hong Kong

Vie CHC11696