

PHILIPS

AZ 7162 / AZ 7167 Portable Compact Disc Player



Instructions for Use
Mode d'emploi
Instrucciones de manejo
Bedienungsanleitung
Gebruiksaanwijzing
Istruzioni per l'uso
Bruksanvisning
Brugsanvisning
Käyttöohje
Οδηγίες χρήσεως
Manual de utilização



PHILIPS

English

English	Controls4-5	Operation8-10
	Power Supply6	General information..11
	Recharging7	Troubleshooting ...12-13
	Connections7	

Français

Français	Commandes14-15	Fonctionnement ...18-20
	Alimentation16	Généralités21
	Recharge17	Dépistage des
	Branchements.....17	pannes22-23

Español

Español	Mandos24-25	Funcionamiento ...28-30
	Alimentación26	Información general..31
	Recarga27	Detección de
	Conexiones.....27	anomalías.....32-33

Deutsch

Deutsch	Bedienungselemente34-35	Bedienung38-40
	Stromversorgung36	Allg. Informationen...41
	Aufladen37	Fehlersuche42-43
	Anschlüsse37	

Nederlands

Nederlands	Bedieningsknoppen..44-45	Bediening48-50
	Voeding46	Algemene gegevens..51
	Opladen.....47	Verhelpen van
	Aansluitingen47	storingen.....52-53

Italiano

Italiano	Comandi54-55	Funzionamento58-60
	Alimentazione56	Informazioni generali..61
	Ricarica57	Ricerca guasti.....62-63
	Collegamenti57	

Svenska	Kontroller64-65	Användning68-70	Svenska
	Strömförsörjning.....66	Allmän information...71	
	Laddning67	Felsökning72-73	
	Anslutningar.....67		
Dansk	Betjeningsknapper ...74-75	Anvendelse.....78-80	Dansk
	Strømforsyning76	Generel information..81	
	Opladning.....77	Fejlsøgning.....82-83	
	Tilslutninger77		
Suomi	Käyttöpainikkeet..84-85	Käyttö88-90	Suomi
	Käyttäjännite.....86	Yleistä91	
	Kuulokkeiden.....87	Tarkistusluettelo ...92-93	
	Kytkenät.....87		
Ελληνικά	Χειριστήρια.....94-95	Γενικές πληροφορίες.....101	Ελληνικά
	Τροφοδοσία.....96	Διόρθωση	
	Συνδέσεις.....97	βλαβών102-103	
	Επαναφόρτιση97		
	Εξαρτήματα.....98-100		
Português	Comandos104+105	Funcionamento.108-110	Português
	Alimentação106	Informações gerais .111	
	Recarga107	Avarias112-113	
	Ligações107		

CONTROLS

English

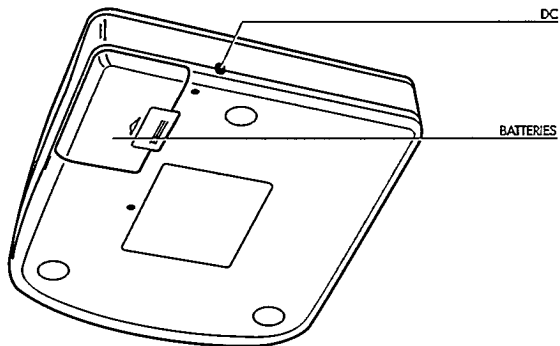
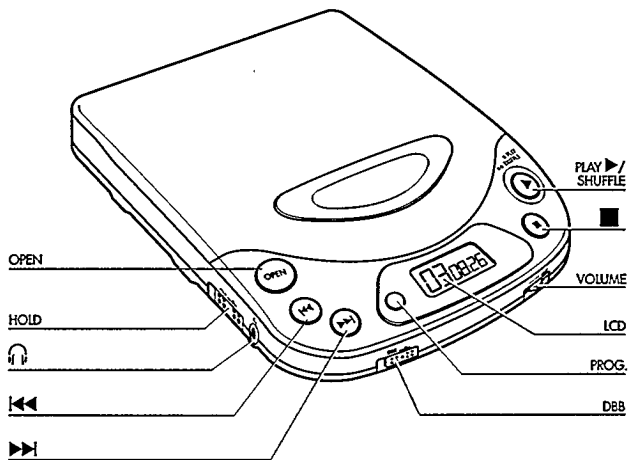

*This set complies with the radio interference requirements of the European Community.
The typeplate is located on the base of the set.*

CONTROLS

- LCD**Window for showing the different playing modes, tracks and times
- OPEN**Button for opening the lid of the CD player
- VOLUME**Control for adjusting the volume at the headphone output
- PLAY ►/SHUFFLE**Button for starting CD play and for playing all tracks in a random order
-Button for stopping CD play, deleting various settings, and switching off the CD player
- ◀◀**Button for selecting the previous music track or, if held down, for searching backward for a particular passage on the CD
- ▶▶**Button for selecting the next music track or, if held down, for searching forward for a particular passage on the CD
- PROG.**Button for storing tracks in a program and for checking the program
- DBB****Dynamic Bass Boost:** switch for boosting the bass response
- HOLD**Switch for activating the HOLD feature (blocking all buttons)
- 🎧**Headphone jack (3.5mm)
- DC**Jack for external power supply
- Battery compartment** ..which holds four batteries

Use your head when using headphones

Hearing safety: Do not play your headphones at a high volume. Hearing experts advise that continuous use at high volume can permanently damage hearing.

Traffic safety: Do not use headphones while driving a vehicle. It may create a hazard and it is illegal in many countries. Even if your headphones are an open-air type designed to let you hear outside sounds, do not turn up the volume so high that you cannot hear what is going on around you.

POWER SUPPLY

English

Mains adapter SBC 6619/6622 *(supplied or optional available)*

- 1 Make sure that the local voltage corresponds to the voltage of the adapter.
 - 2 Connect the mains adapter to the player's DC socket and to the wall outlet.
- Always disconnect the adapter if you are not using it.

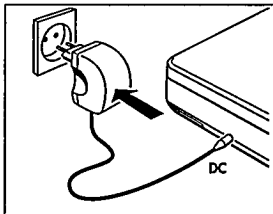

Batteries, type R6, UM3 or AA *(supplied or optional available)*

- Open the battery compartment and insert four rechargeable Nickel-Cadmium batteries or alkaline batteries.

Approx. playing times under normal conditions:

-Alkaline batteries: 12 hours

-Nickel-Cadmium batteries: 4 hours

- Remove the batteries if they are empty or the CD player is not to be used for a long time.

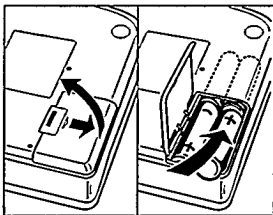

Recharging of Philips SBC 6445 Ni-Cad batteries on board

The batteries are ***always and automatically recharged*** when the mains adapter is connected. Approx. charging time: 14 hours.

Notes:

- When using *Nickel-Cadmium batteries*, we advise to use the *Philips batteries SBC 6445 only*, as conventional *Nickel-Cadmium batteries* cannot be recharged on board.
- To ensure a long life for your *Nickel-Cadmium batteries*, charging will automatically be interrupted at high ambient temperatures (e.g. in a car during summer).
- If you don't use the *Philips batteries SBC 6445* frequently, we advise to completely discharge and recharge the batteries approx. once a month.

Connecting headphones (supplied)

- Connect the supplied headphones (16-32 ohms /3.5mm jack plug) with the  jack.

Note : Use this jack also for connecting
- your HiFi system (signal lead) or your car radio: in both cases the volume of the CD player has to be set to midposition (approx. 6-8).

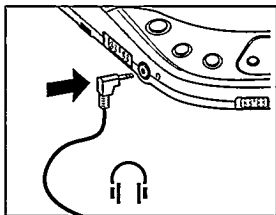

OPERATION

English

Playing a CD

- 1 Open the lid by pressing the OPEN button.
- 2 Insert an audio CD, printed side up.
- 3 Close the lid by pushing it on its left side.
- 4 Press the PLAY ►/SHUFFLE button to start CD play.
→ Display indication of: (example)
2 = current track / 1:08 = elapsed time of current track

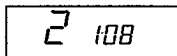

- 5 Adjust the sound using the controls VOLUME and DBB.
- 6 If you press the PLAY ►/SHUFFLE button during CD play, all tracks will be played in a random order. Press the button again, to return to normal CD play.

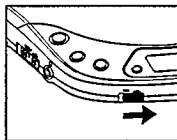

- 7 Press the ■ button to stop CD play.
→ Display indication of: (example)
23 = total number of tracks / 69:33 = total playing time

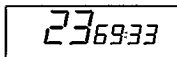

- If you press the ■ button again, you will switch off the set.

Note: If no button is pressed for 60 seconds, the set will switch off automatically.

Inserting the CD

- Push gently on the CD center so that it fits onto the hub.

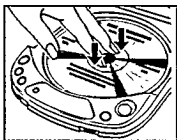

Removing the CD

- Hold the CD by its edge and press the hub gently.

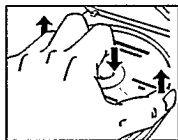



Selecting another track

- Briefly press the **◀◀** or **▶▶** button once/several times to skip to the beginning of the current/previous or next track(s).
 - Display indication of: selected track number.
 - During play: CD play continues automatically with the selected track.
 - In stop position: press the **▶**/SHUFFLE button to start CD play.

Searching for a passage during CD play

- 1 Hold down the **◀◀** or **▶▶** button to find a particular passage in forward or backward direction.
 - CD play continues at a low volume.
- 2 Release the button when you have reached the desired passage.

Note: In the shuffle mode or when playing a program, searching is only possible within the particular track.

HOLD – Deactivating all buttons

- Slide the switch to the right to deactivate all buttons (except the button OPEN).
 - Display indication: HOLD.
 - Now, the set is protected against accidentally touching of the buttons when carrying the CD player around.

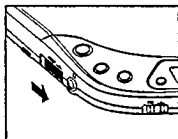

OPERATION

PROG -- programming of tracks

You may select a number of tracks and store these in the memory in the desired sequence. You may store any track more than once. At most, 20 tracks can be stored in the memory.

- 1 Select with ◀◀ or ▶▶ the desired track.
- 2 As soon as the desired track is displayed, press the PROG. button to store the track in the memory.
→ Display indication of: track number / P / total number of stored tracks (example).
- 3 Select and store in this way all desired tracks.

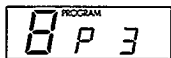

- You can review your settings by pressing the PROG. button for more than 1 second.
→ The display shows in sequence all stored track numbers.
If no program is stored, NO PROG appears on the display.

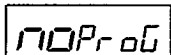

Notes:

- When you try to store more than 20 tracks, the display indicates FULL.
- When you press PROG. and there is no track selected, the display indicates SELECT.

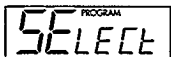

Playing the program:

- If you have selected the tracks in STOP mode, press the PLAY ▶/SHUFFLE button.
- If you have selected the tracks during CD play, first press the ■ and then the PLAY ▶/SHUFFLE button.

Erasing the program in STOP mode:

- Press the ■ button to erase the program.
→ On the display CLEAR briefly lights up, and PROGRAM disappears.



Note: Interrupting the power supply or opening the lid will also erase the program.

GENERAL INFORMATION

Maintenance and CD handling

- The lens (⊗) of the CD player should never be touched!
- Do not expose the CD player, batteries or CDs to rain, dampness, sand, dust or excessive heat caused by heating equipment, or to direct sunlight (for example inside a car parked in the sun).
- The lens may cloud over when the set is suddenly moved from cold to warm surroundings. Playing a CD is then not possible. Leave the CD player in a warm environment until the moisture evaporates.
- You can clean the CD player with a soft and slightly dampened chamois leather. Do not use any cleaning agents as they may have a corrosive effect.
- Always pick up the CD by the edge and put it back in its box after use.
- To clean the CD, wipe it off in a straight line from the center towards the edge using a soft, lint-free cloth. A cleaning agent may damage the disc!
- When a newly purchased CD does not stay on the hub, this is caused by small burrs around the center hole of the CD. Remove the burrs by rubbing the edge of the center hole with a pen or other such instrument.



English

Environmental information

- Please observe the local regulations regarding the disposal of packing materials, exhausted batteries, and old equipment.
- All redundant packaging material has been omitted. We have done our utmost to make the packaging easy separable into three mono-materials: cardboard (box), expandable polystyrene (buffer), polyethylene (bags, protective foam sheet)
- Your set consists of materials which can be recycled if disassembled by a specialized company.
- Do not dispose of exhausted batteries with your household waste.

TROUBLESHOOTING

English

- If a fault occurs, please check the points listed below before taking your set for repair.
- If you are not able to remedy a problem by following these hints, consult your dealer or service facility.

Problem	Possible cause	Remedy
No power	Batteries Batteries incorrectly inserted	Insert the batteries correctly
	Batteries are empty	Change/recharge the batteries
	Contact pins are dirty	Clean them with a cloth
	Mains adapter Loose connection	Connect the adapter securely
	In-car use Cigarette lighter is not powered when ignition is switched off	Insert batteries as an additional power supply
CD play does not start or interrupts Display: -no indication or -HOLD or -ERROR or -NO DISC	CD lid is not securely closed	Close the lid securely
	HOLD feature is activated	Switch off the HOLD feature
	Moisture condensation	Leave the player in a warm place until the moisture evaporates
	CD is not or incorrectly inserted	Insert a CD, label facing up
	CD is badly scratched	Use another CD
	CD is dirty	Clean the CD
	Batteries are empty	Change/recharge the batteries
Battery-recharging on board doesn't work	Use of wrong batteries	Only SBC 6445 NiCd batteries can be recharged on board
	Contacts are dirty	Clean them with a cloth

TROUBLESHOOTING

Under no circumstances should you try to repair the unit yourself, as this will invalidate the warranty.

English

Problem	Possible cause	Remedy
No sound or bad sound quality	<u>Loose or wrong connections</u>	Check connections
	Volume is not turned up	Adjust the volume
	Headphones worn the wrong way	Pay attention to the L (left) and R (right) indications
	Headphone plug is dirty	Clean the headphone plug
	Strong magnetic fields near the CD player	Change the player's position or connections
	Electrostatic discharge from the user via the CD player	Press ◀◀ or ▶▶ once or press PLAY ▶/SHUFFLE twice
	In-car use	
	Strong vibrations	Find another place for the set
	Adapter cassette is incorrectly inserted	Insert the adapter cassette correctly
	Temperature inside car is too high/low	Let the CD player acclimatize
Cigarette lighter/jack is too dirty	Clean the cigarette lighter/jack	
Wrong playback direction of the auto reverse feature of the car cassette player	Change the auto reverse direction	
Hum or noise in-car	Unfit car radio input jack	Use the adapter cassette













Deutschland

Hiermit wird bescheinigt, daß dieses Gerät in Übereinstimmung mit den Bestimmungen der Amtsblattverfügung 1046/1984 funktionsstört ist.
Der Deutschen Bundespost wurde das Inverkehrbringen dieses Gerätes angezeigt und die Berechtigung zur Überprüfung der Serie auf Einhaltung der Bestimmungen eingeräumt.

Norge

Typeskilt finnes på apparatens underside.

**CLASS 1
LASER PRODUCT**

