

# PHILIPS

AZ 6837 Portable Compact Disc Player

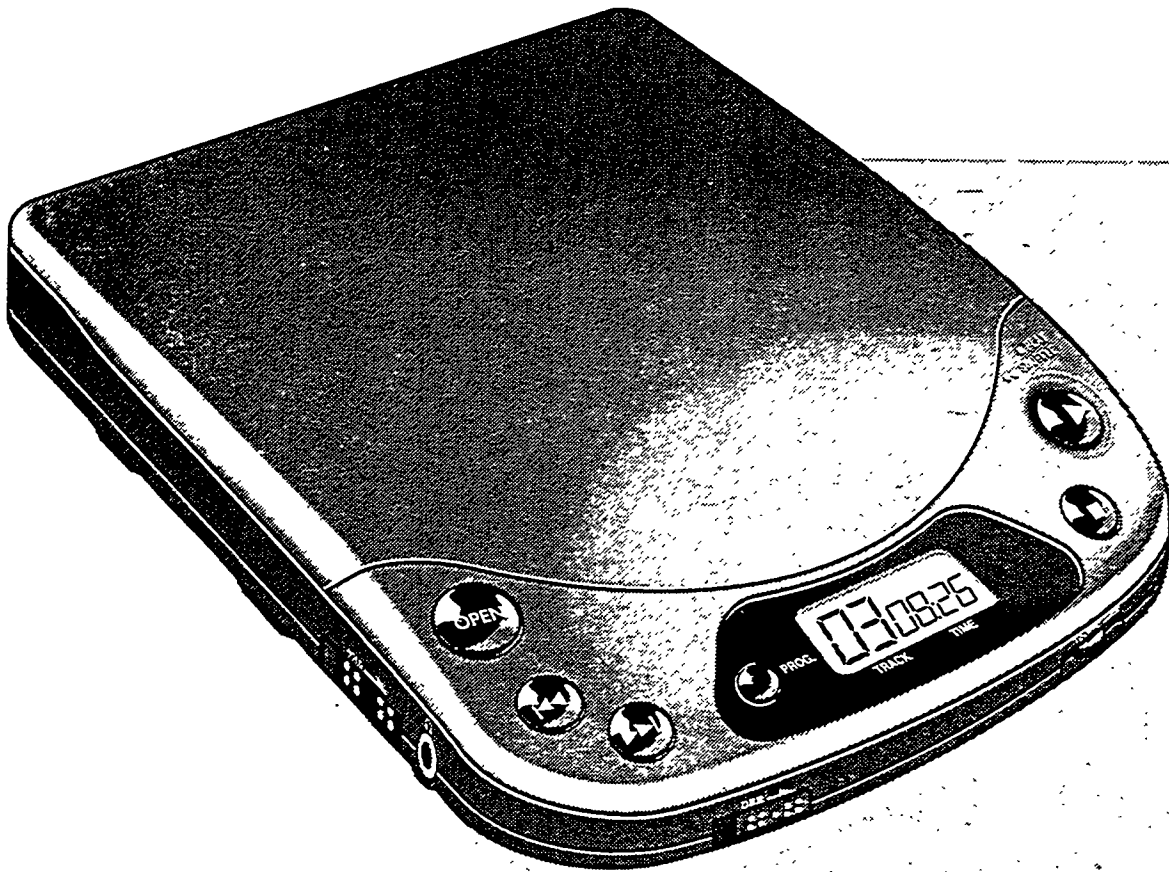

Instructions for Use  
Mode d'emploi  
Instrucciones de manejo  
使用説明書



# PHILIPS

---

**Australia**

Guarantee and Service .....page 52

**New Zealand**

Guarantee and Service .....page 53

**Mexico**

Es necesario que lea cuidadosamente su instructivo de manejo. ....**NOM**  
Garantía .....pág. 54

## Ottimizzazione della calibratura del percorso (A partire da software aprile 1996)

Per un adeguamento del percorso rilevato dal computer di navigazione al tratto realmente percorso è possibile usare il punto „Correzione del sensore“ nel menu „Regolazioni“. Il valore di calibratura per i sensori sulla ruota può essere qui spostato da -3,0 % fino a +3,0 % con passi di 0,1 %. E' necessario procedere alla correzione di questo valore solo quando sullo schermo vedete che il simbolo del veicolo sulla cartina digitalizzata è decisamente troppo indietro o troppo avanti in confronto alla posizione reale. Durante un viaggio su rettilineo potete verificare questa situazione usando come punti di riferimento sia ponti sull'autostrada che incroci di strade. Se dopo un tratto dritto di ad. es. 5 km si rileverà un ritardo di circa 50 m, al valore percentuale esistente si dovrà allora addizionare un ulteriore valore di +1%. Per fare questo procedete così:

1. Percorrete un tratto senza forti curve di una lunghezza di 5 - 10 km.
2. Sminate la differenza fra la carta sullo schermo e la realtà aiutandovi con ponti sull'autostrada, incroci o sbocchi. Durante questo confronto la velocità di marcia non deve mai superare i 100 km/h.
3. In caso di ritardo si deve addizionare, e in caso di anticipo defalcare, il valore percentuale rilevato ed a veicolo fermo immettere poi il risultato nel menu „Correzione del sensore“ (se possibile non cambiare più di 1 % per passo). Lo svolgimento della registrazione è il seguente: mediante i tasti cursore selezionare il punto „Fattore di corr.“, attivare con il tasto Enter, con i tasti cursore cambiare il valore esistente e confermare con il tasto Enter. Successivamente viene assunto il valore regolato e commutato nel menu principale.
4. Abbandonare il percorso rettilineo e percorrere almeno 2 - 3 curve (possibilmente a 90° o uscite dell'autostrada) su strada digitalizzata.
5. Controllare la nuova regolazione ripercorrendo un tratto rettilineo di almeno 5 - 10 km.
6. Se necessario ripetere i punti 2 fino 5. Qualora il comportamento di navigazione del vostro veicolo fosse peggiorato, selezionate sul menu la voce „Valore standard“ (valore di correzione 0,0 %) e ricominciate dal punto 1.

### Indicazioni:

- La distanza fino al punto di svolta a un incrocio o a un imbocco viene sempre calcolata fino al centro dell'incrocio.
- Un errore di 10 m è assolutamente normale.
- La calibratura del sensore è correttamente eseguita, quando si osserva un errore di all'incirca +/- 10 m sia di anticipo che di ritardo. Questo valore corrisponde alla precisione della carta digitalizzata.

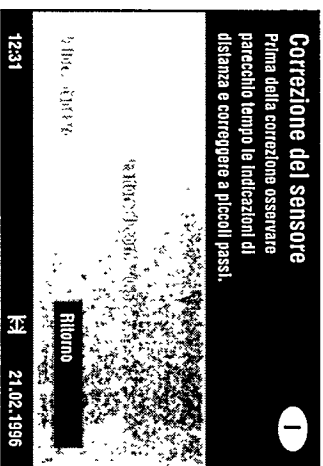

Se preferite comunque non eseguire voi stessi le operazioni di ottimizzazione del sensore, rivolgetevi per cortesia a una officina autorizzata.

## Optimization of distance calibration (from software release April 1996 on)

For later adjustment of the distance calculated by the navigation computer compared to the real driven distance, you can select the option "Sensor correction" from the "System Settings" menu. You can adjust the calibration factor for the wheel sensors between -3,0 % to +3,0 % in steps of 0,1 %. You only have to change this factor if there is a bigger difference between the car symbol on the route map and reality. You can check this by means of bridges and junctions after driving a long distance straight ahead.

If for example there is a negative difference of approx. 50 m after driving 5 km straight ahead, you have to add a value of 1 % to the existing proportional factor. For that purpose proceed as follows:

1. Drive a distance of approx. 5 - 10 km without any strong bends.
2. Estimate the difference between the map display (route map) and reality by means of motorway bridges junctions or exits. Do not drive faster than 100 km/h during this process.
3. In case of a negative difference you have to add, otherwise you have to subtract the previously calculated proportional value. Enter the correction factor in the "Sensor correction" menu when you have stopped the car. Avoid changing the value more than 1 % in one go:  
Select "Correction factor" with the cursor keys and confirm with the Enter key. Then change the existing value with the cursor keys and confirm with the Enter key. The adjusted factor is stored and the systems switches back to the "Main menu".
4. Turn off the straight road and drive round 2 - 3 strong bends (if possible 90° or a motorway exit) on digitized roads.
5. Check the new adjustment by driving along a straight road of 5 - 10 km again.
6. If necessary, repeat steps 2. to 5. If contrary to expectation the navigational characteristics have deteriorated, select the option "Default" (Correction factor 0.0 %) from the "Sensor correction" menu and start over with step 1.

### Notes:

- The distance to the turning point on a junction is always measured at the centre of the junction.
- A tolerance of 10 m is absolutely in the limits.
- The sensor calibration is done correctly if you observe both a positive and a negative difference of approx. 10 m. This meets the precision of the digitized map.

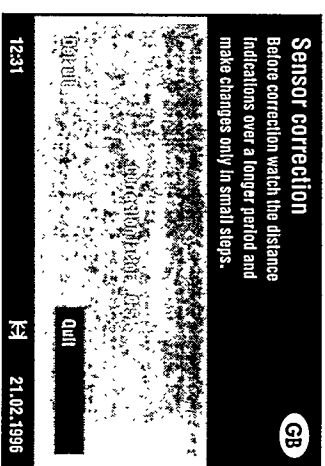

If you do not wish to carry out the sensor calibration yourself, contact your authorized service.

## Optimisation de la calibration des trajets (Logiciel depuis avril 1996)

Pour faire concorder à posteriori la distance déterminée par l'ordinateur et celle effectivement parcourue, utilisez le point "Correction de capteur" dans le menu "Configuration du système". La valeur de calibration des capteurs de roue se règle entre - et + 3,0 % par pas de 0,1 %. Vous ne devez modifier cette valeur que si sur la carte affichée par l'écran vous constatez que le symbole Véhicule prend un retard/une avance net(te). Contrôlez-le, après une longue ligne droite, lorsque vous passer un pont d'autoroute ou un carrefour. Exemple: si après 5 km de ligne droite la dérive est de 50 m, rajoutez 1 % au pourcentage actuellement réglé. Procédure:

1. Parcourez une distance de 5 à 10 km exempte de virages prononcés.
2. A l'aide des ponts d'autoroutes, de carrefours en croix ou en T, estimez la différence entre ce qu'indique la carte et la réalité. Ne roulez jamais à plus de 100 km/h.
3. Si le symbole a du retard sur la réalité, ajoutez le pourcentage déterminé, si le symbole est en avance, soustrayez ce pourcentage puis, véhicule immobile, programmez le résultat sous le menu "Correction de capteur" (si possible, ne modifiez pas de plus de 1 % d'un coup). Déroulement de la programmation: sélectionnez le point "Facteur de corr." au moyen des touches curseur, puis validez par la touche Enter. L'appareil mémorise le nouveau pourcentage puis commute sur le menu principal ("Sommaire").
4. Quittez la route droite et empruntez-en une autre numérisée comportant au moins 2 ou 3 virages serrés (obligeant à virer à moins de 90°, ou roulez sur autoroute).
5. Contrôlez le nouveau réglage en roulant à nouveau 5 - 10 km en ligne droite.
6. Si nécessaire, effectuez à nouveau les opérations énoncées aux points 2 à 5. Si contre toute attente la précision de navigation a diminué, sélectionnez le point de menu "Valeur standard" (pourcentage de correction: 0,0 %) puis reprenez la procédure depuis le point 1.

### Remarques:

- La distance jusqu'au au point de virage à un carrefour en croix ou en T est toujours calculée par l'appareil jusqu'au centre du carrefour.
- Une imprécision de 10 m est absolument normale.
- Les capteurs sont correctement calibrés si le retard ou l'avance se tient dans une plage de  $\pm 10$  mètres. Ce degré de précision équivaut à celui de la carte numérisée.

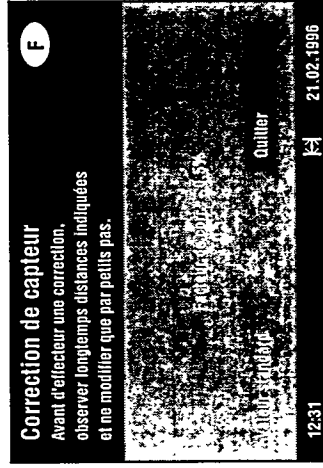

Si vous ne désirez pas optimiser vous-même le réglage des capteurs, adressez-vous à un atelier agréé du service après-vente (SAV).

## Optimierung der Wegstrecken-Kalibrierung (Ab Softwarestand April 1996)

Zur nachträglichen Anpassung der vom Navigationscomputer ermittelten Strecke an den tatsächlich gefahrenen Weg ist es möglich, den Punkt „Sensor Korrektur“ im Menü „Einstellungen“ zu verwenden. Der Kalibrierwert für die Radsensoren kann hier von -3,0 % bis + 3,0 % in 0,1 %-Schritten verstellt werden. Die Notwendigkeit zur Verstellung dieses Wertes ergibt sich nur, wenn Sie feststellen, daß auf dem Monitor das Fahrzeugsymbol in der Karte gegenüber der Wirklichkeit deutlich nachläuft oder vorausläuft. Man kann dies nach einer längeren Geradeausfahrt anhand von Autobahnbrücken oder Straßenkreuzungen kontrollieren. Ergibt sich z. B. nach 5 km gerader Fahrt ein Nachlaufen von etwa 50 m, so muß zu dem vorhandenen prozentualen Wert ein zusätzlicher Wert von + 1 % addiert werden. Gehen Sie dabei wie folgt vor:

1. Fahren einer Strecke ohne stärkere Kurven von etwa 5 - 10 km Länge.
2. Abschätzen der Differenz zwischen Kartendarstellung und Wirklichkeit anhand von Autobahnbrücken, Kreuzungen oder Einmündungen. Während des Vergleichs keinesfalls mehr als 100 km/h fahren.
3. Bei Nachlaufen addieren, bei Vorausläufen subtrahieren des ermittelten prozentualen Wertes und bei stehendem Fahrzeug eintragen des Ergebnisses im Menü „Sensor Korrektur“ (möglichst nicht mehr als 1 % in einem Schritt verändern). Der Ablauf der Eintragung ist folgender: Anwählen des Punktes „Korrekturfaktor“ mit den Cursor-Tasten, aktivieren mit der Enter-Taste, verändern des bestehenden Wertes mit den Cursor-Tasten und bestätigen mit der Enter-Taste. Danach wird der eingestellte Wert übernommen und in das Hauptmenü umgeschaltet.
4. Abbiegen von der geraden Strecke und fahren von mindestens 2-3 starken Kurven (möglichst 90° oder Autobahnabfahrt) auf digitalisierten Straßen.
5. Kontrolle der neuen Einstellung durch erneutes Fahren einer geraden Strecke von etwa 5 - 10 km Länge.
6. Wenn notwendig, Wiederholung der Punkte 2. bis 5. Sollten sich wider Erwarten die Navigations-eigenschaften Ihres Fahrzeuges eher verschlechtern, wählen Sie bitte den Menüpunkt „Voreinstellung“ (Korrekturwert: 0,0 %) und beginnen wieder bei Punkt 1.

### Hinweise:

- Die Distanz zum Abbiegepunkt auf einer Kreuzung oder Einmündung wird immer bis zum Kreuzungsmittelpunkt gerechnet.
- Die Entfernung bis zur Ausfahrt auf einer Autobahn ist immer bis zur rot-weiß gestreiften Warmbake gerechnet.
- Eine Abweichung von 10 m ist absolut normal.
- Die Sensorkalibrierung ist dann richtig eingestellt, wenn im Rahmen von etwa +/- 10 m sowohl ein Vorauslaufen als auch ein Nachlaufen zu beobachten ist.

Dies entspricht der Genauigkeit der digitalisierten Karte.

Sollten Sie selbst die Sensor-Optimierung nicht durchführen wollen, wenden Sie sich bitte an Ihre autorisierte Servicewerkstatt.

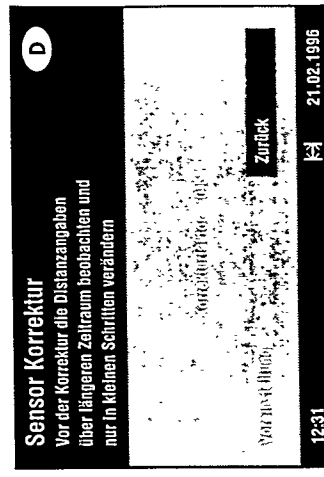

<b>English</b>	Controls .....4-5 Accessories.....6 Connections .....6-8 Power Supply .....9	Operation .....10-12 General information..13 Troubleshooting .14-15	<b>English</b>
<b>Français</b>	Commandes .....16-17 Accessoires.....18 Branchements ....18-20 Alimentation .....21	Fonctionnement 22-24 Généralités .....25 Dépiçtage des pannes .....26-27	<b>Français</b>
<b>Español</b>	Mandos.....28-29 Accesorios .....30 Conexiones .....30-32 Alimentación.....33	Funcionamiento..34-36 Información general..37 Detección de anomalías.....38-39	<b>Español</b>
<b>中文</b>	控制器 .....40-41 附件 .....42 連接 .....42-44 電源供給 .....45	操作 .....46-48 一般說明 .....49 故障排除 .....50-51	<b>中文</b>

# CONTROLS

English

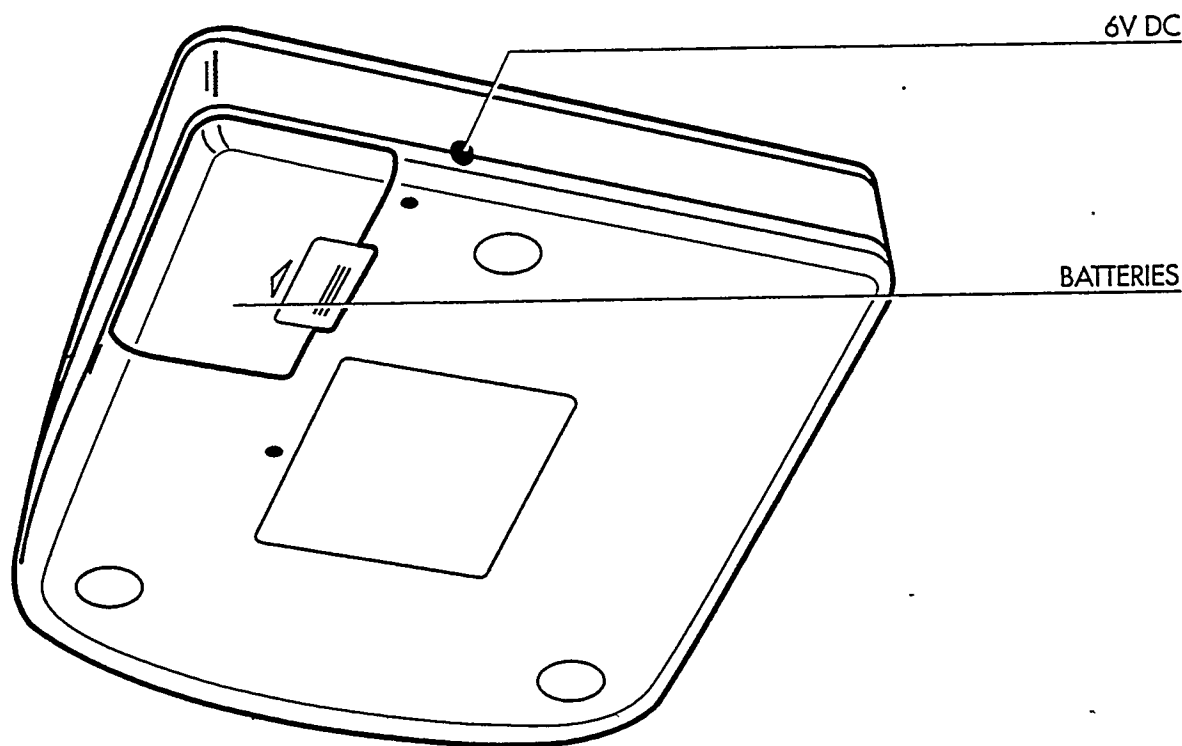
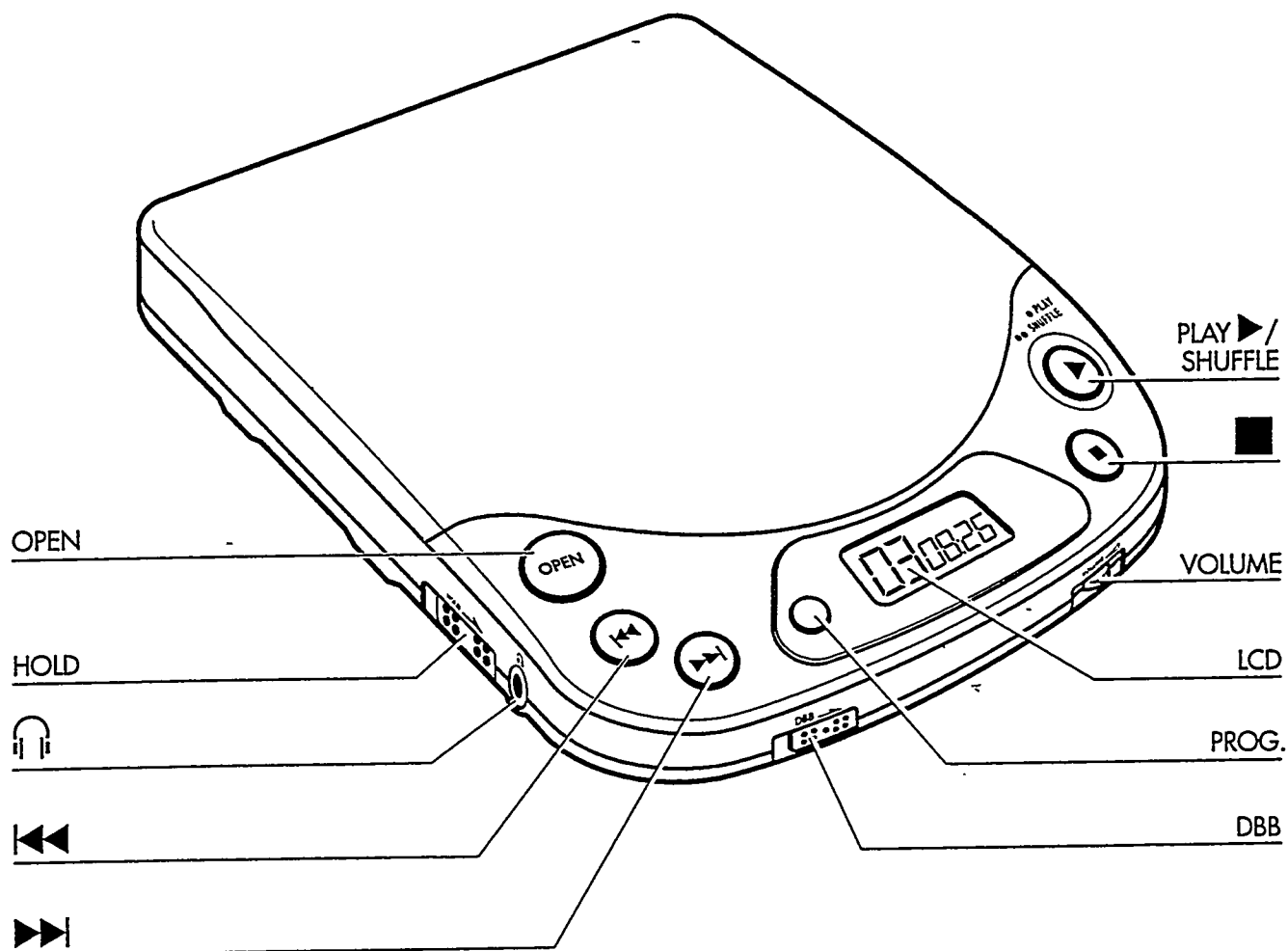

*The typeplate is located on the base of the set.*

# CONTROLS

- LCD** ..... Window for showing the different playing modes, tracks and times
- OPEN** ..... Button for opening the lid of the CD player
- VOLUME** ..... Control for adjusting the volume at the headphone output
- PLAY ►/SHUFFLE** ..... Button for starting CD play and for playing all tracks in a random order
- ..... Button for stopping CD play, deleting various settings, and switching off the CD player
- ◀◀ ..... Button for selecting the previous music track or, if held down, for searching backward for a particular passage on the CD
- ▶▶ ..... Button for selecting the next music track or, if held down, for searching forward for a particular passage on the CD
- PROG.** ..... Button for storing tracks in a program and for checking the program
- DBB** ..... **Dynamic Bass Boost:** switch for boosting the bass response
- HOLD** ..... Switch for activating the HOLD feature (blocking all buttons)
- 🎧 ..... Headphone jack (3.5mm)
- 6 V DC** ..... Jack for external power supply
- Battery compartment** ..which holds four batteries

## Use your head when using headphones

**Hearing safety:** Do not play your headphones at a high volume. Hearing experts advise that continuous use at high volume can permanently damage hearing.

**Traffic safety:** Do not use headphones while driving a vehicle. It may create a hazard and it is illegal in many countries. Even if your headphones are an open-air type designed to let you hear outside sounds, do not turn up the volume so high that you cannot hear what is going on around you.

## Accessories

*(supplied or optional available from your dealer or Philips Service Center)*

*Note: Please ask your dealer for detailed information since not all accessories may be available in your country.*

**SBC 6608** - mains adapter 6 V/400 mA, Direct Current plus-pole to the center pin.

**SBC 1059** - signal lead with 3.5 mm stereo plug and two cinch plugs.

**SBC 1085** - signal lead with 3.5 mm jack plug at both ends.

**SBC 8254/8232/3207/3208** - mini loudspeakers with amplifier.

**SBC 6255/SBC 6250** - pouch to protect the CD player when carrying around.

### Car accessories

**SBC 3557 Mk III** - car accessory kit (adapter cassette and voltage converter).

**SBC 3547 Mk II** - shock absorbant car mounting plate on a flexible "swan neck"

## Connecting headphones *(supplied)*

- Connect the supplied headphones (16-32 ohms /3.5mm jack plug) with the  jack.

*Note : Use this jack also for connecting*

*- your HiFi system (signal lead SBC 1059) or  
your car radio (the cassette adapter from the  
car accessory kit SBC 3557 or the signal lead  
SBC 1085): in both cases the volume of the CD  
player has to be set to midposition (approx. 6-8);*

*- mini-loudspeakers SBC 8254/8232/3207/3208, see accessories.*

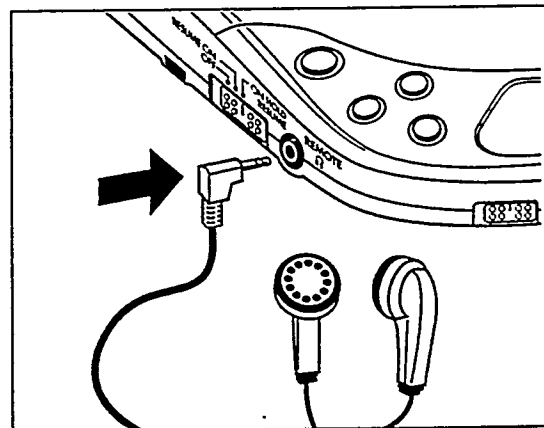



# CONNECTIONS

## Active loudspeakers

- 1 Connect the left loudspeaker to the right loudspeaker.
- 2 Connect the right loudspeaker to the  jack of the CD player.
- 3 Activate the loudspeakers by sliding the **POWER** switch at the back of the right loudspeaker to the **ON** position.
- 4 Start the CD player, set the volume between 6 and 8 and adjust the sound with the loudspeaker controls.

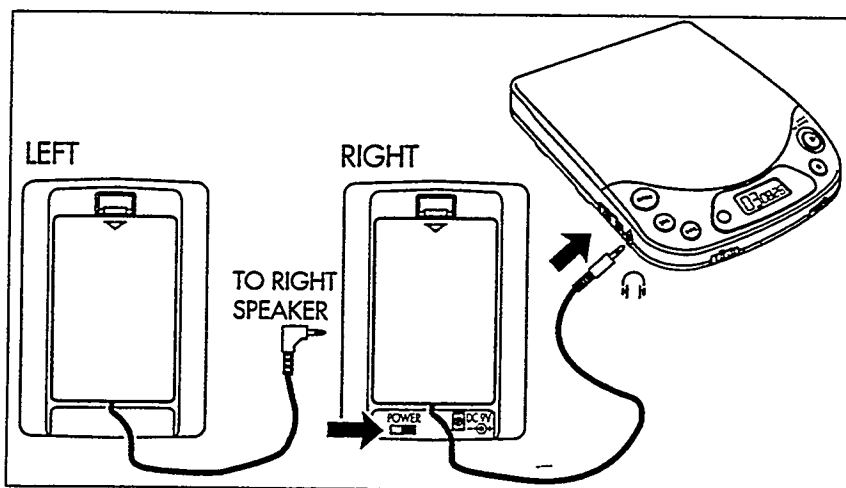

English

### Notes:

- To avoid unnecessary power consumption, switch off the active loudspeakers when not in use.
- Pay attention to the polarity and voltage indicated on the loudspeakers when connecting them to an external power source.

## CD OUT – reproduction through a stereo system

- 1 Turn down the volume of your stereo system.
- 2 Connect the supplied signal lead SBC1059 to the  jack of the CD player and to the input sockets CD IN, AUX(iliary) or LINE IN of the other set (amplifier, radio cassette recorder etc.).
- 3 Start the CD player, set the volume between 6 and 8 and adjust the sound with the controls of the stereo system.

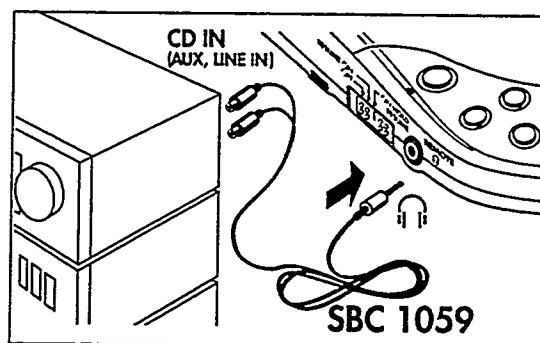

# CONNECTIONS

English

## Connections for in-car use

- 1 Find a good and safe place for the CD player on a horizontal, vibration-free and stable surface that is not dangerous or in the way of the driver or passengers.
  - 2 Connect the DC plug of the voltage converter (6V/500 mA Direct Current,  $\diamond \rightarrow \ominus \diamond$  plus-pole  $\diamond$  to the center pin, *only for a 12 V car battery, negative grounding*) to the 6 V DC socket of your CD player.
  - 3 Then insert the voltage converter into the cigarette lighter socket. If necessary, clean the cigarette lighter socket to obtain a good electrical contact.
  - 4 Turn down the volume and **switch off the autoreverse function (if present) of your car radio cassette player.**
  - 5 Connect the cassette adapter plug to the  $\text{Ⓜ}$  socket of the CD player.
  - 6 Slide the cassette adapter carefully into the car radio cassette player.
  - 7 Make sure that the cord does not hinder your driving.
  - 8 Start the CD player, turn its volume to midposition (approx. position 6-8) and adjust the sound with the car radio controls.
- To remove the cassette adapter press the eject button of the car radio.
  - Always remove the voltage converter when the CD player is not in use.

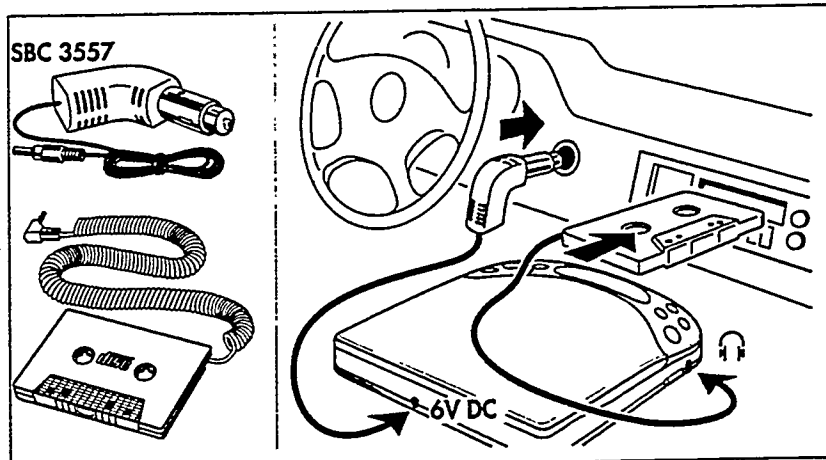

### Notes on In-car Use:

- Avoid excessive heat from the car heating or from direct sunshine (e.g., when parking in the sun).
- Do not remove the protective film from the metal head of the cassette adapter.
- If your car radio has a LINE IN jack, it is best to use it for the car radio connection instead of the cassette adapter. Connect the signal lead SBC 1085 (optional) to this LINE IN jack and the  $\text{Ⓜ}$  jack of the CD player.

# POWER SUPPLY

## Mains adapter SBC6608

- 1 Make sure that the local voltage corresponds to the voltage of the adapter (see accessories).
  - 2 Connect the mains adapter to the player's 6V DC socket and to the wall outlet.
- Always disconnect the adapter if you are not using it.

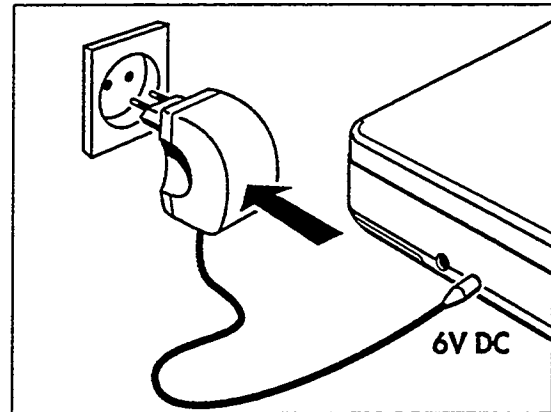

English

## Batteries, type R6, UM3 or AA

- Open the battery compartment and insert four rechargeable Nickel-Cadmium batteries or alkaline batteries.

Approx. playing times under normal conditions:

-Alkaline batteries: 12 hours

-Nickel-Cadmium batteries: 4 hours

- Remove the batteries if they are empty or the CD player is not to be used for a long time.

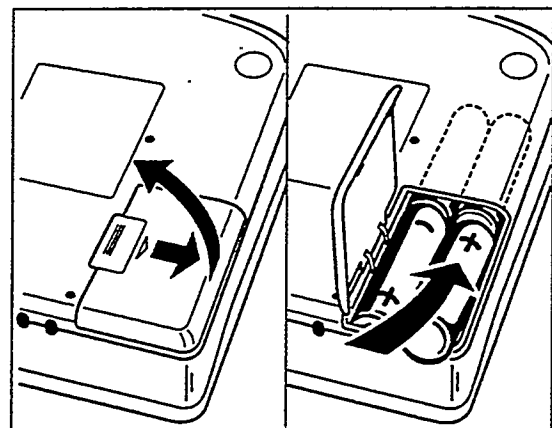

# OPERATION

English

## Playing a CD

- 1 Open the lid by pressing the OPEN button.
- 2 Insert an audio CD, printed side up.
- 3 Close the lid by pushing it on its left side.
- 4 Press the PLAY ►/SHUFFLE button to start CD play.  
→ Display indication of: (example)  
2 = current track / 1:08 = elapsed time of current track

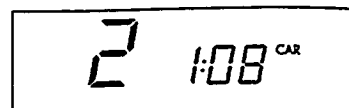

- 5 Adjust the sound using the controls VOLUME and DBB.
- 6 If you press the PLAY ►/SHUFFLE button during CD play, all tracks will be played in a random order. Press the button again, to return to normal CD play.

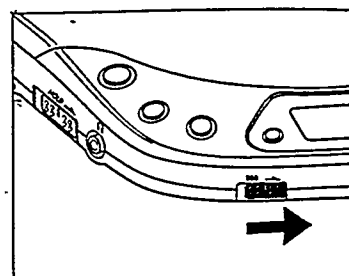

- 7 Press the ■ button to stop CD play.  
→ Display indication of: (example)  
23 = total number of tracks / 69:33 = total playing time

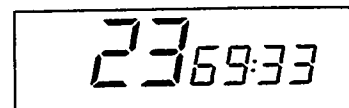

- If you press the ■ button again, you will switch off the set.

*Note: If no button is pressed for 60 seconds, the set will switch off automatically.*

## Inserting the CD

- Push gently on the CD center so that it fits onto the hub.

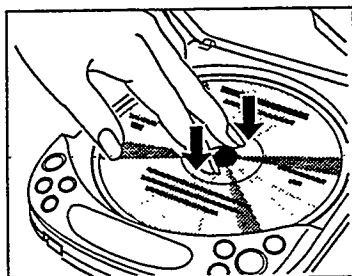

## Removing the CD

- Hold the CD by its edge and press the hub gently.

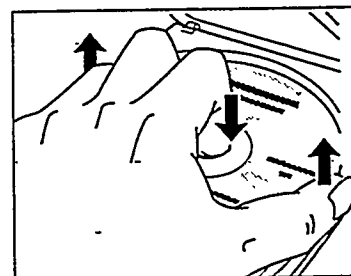

# OPERATION



## Selecting another track

- Briefly press the **⏮** or **⏭** button once/several times to skip to the beginning of the current/previous or next track(s).
  - Display indication of: selected track number.
  - During play: CD play continues automatically with the selected track.
  - In stop position: press the **▶/SHUFFLE** button to start CD play.

English

## Searching for a passage during CD play

- 1 Hold down the **⏮** or **⏭** button to find a particular passage in forward or backward direction.
  - CD play continues at a low volume.
- 2 Release the button when you have reached the desired passage.

*Note: In the shuffle mode or when playing a program, searching is only possible within the particular track.*

## HOLD – Deactivating all buttons

- Slide the switch to the right to deactivate all buttons (except the button OPEN).
  - Display indication: HOLD.
  - Now, the set is protected against accidentally touching of the buttons when carrying the CD player around.

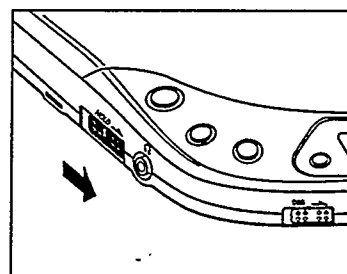

# OPERATION

English

## PROG – programming of tracks

You may select a number of tracks and store these in the memory in the desired sequence. You may store any track more than once. At most, 20 tracks can be stored in the memory.

- 1 Select with ◀◀ or ▶▶ the desired track.
- 2 As soon as the desired track is displayed, press the PROG. button to store the track in the memory.  
→ Display indication of: track number /  
P / total number of stored tracks (example).
- 3 Select and store in this way all desired tracks..



- You can review your settings by pressing the PROG. button for more than 1 second.  
→ The display shows in sequence all stored track numbers.  
If no program is stored, NO PROG appears on the display.



### Notes:

- When you try to store more than 20 tracks, the display indicates FULL.
- When you press PROG. and there is no track selected, the display indicates SELECT.



### Playing the program:

- If you have selected the tracks in STOP mode, press the PLAY ▶/SHUFFLE button.
- If you have selected the tracks during CD play, first press the ■ and then the PLAY ▶/SHUFFLE button.

### Erasing the program in STOP mode:

- Press the ■ button to erase the program.  
→ On the display CLEAR briefly lights up, and PROGRAM disappears.



*Note: Interrupting the power supply or opening the lid will also erase the program.*

# GENERAL INFORMATION

## Maintenance and CD handling

- The lens (X) of the CD player should never be touched!
- Do not expose the CD player, batteries or CDs to rain, dampness, sand, dust or excessive heat caused by heating equipment, or to direct sunlight (for example inside a car parked in the sun).
- The lens may cloud over when the set is suddenly moved from cold to warm surroundings. Playing a CD is then not possible.  
Leave the CD player in a warm environment until the moisture evaporates.
- You can clean the CD player with a soft and slightly dampened chamois leather. Do not use any cleaning agents as they may have a corrosive effect.

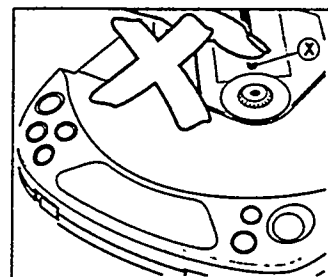

English

- Always pick up the CD by the edge and put it back in its box after use.
- To clean the CD, wipe it off in a straight line from the center towards the edge using a soft, lint-free cloth.  
A cleaning agent may damage the disc!

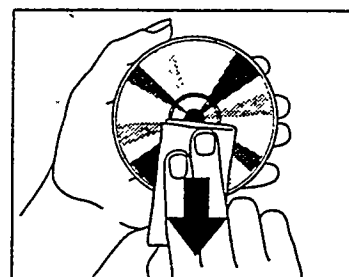

- When a newly purchased CD does not stay on the hub, this is caused by small burrs around the center hole of the CD. Remove the burrs by rubbing the edge of the center hole with a pen or other such instrument.

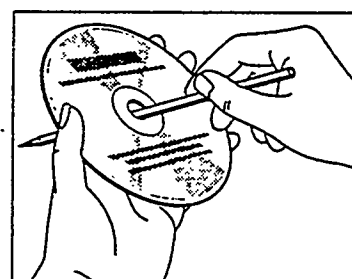

## Environmental information

- Please observe the local regulations regarding the disposal of packing materials, exhausted batteries, and old equipment.
- All redundant packaging material has been omitted. We have done our utmost to make the packaging easy separable into three mono-materials: cardboard (box), expandable polystyrene (buffer), polyethylene (bags, protective foam sheet)
  - Your set consists of materials which can be recycled if disassembled by a specialized company.
  - Do not dispose of exhausted batteries with your household waste.

# TROUBLESHOOTING

- If a fault occurs, please check the points listed below before taking your set for repair.
- If you are not able to remedy a problem by following these hints, consult your dealer or service facility.

English

Problem	Possible cause	Remedy
<b>No power</b>	<b>Batteries</b>	
	Batteries incorrectly inserted	Insert the batteries correctly
	Batteries are empty	Change/recharge the batteries
	Contact pins are dirty	Clean them with a cloth
	<b>Mains adapter</b>	
	Loose connection	Connect the adapter securely
<b>CD play does not start or interrupts</b>	<b>In-car use</b>	
	Cigarette lighter is not powered when ignition is switched off	Insert batteries as an additional power supply
	CD lid is not securely closed	Close the lid securely
	<b><i>HOLD feature is activated</i></b>	<b><i>Switch off the HOLD feature</i></b>
	Moisture condensation	Leave the player in a warm place until the moisture evaporates
	CD is not or incorrectly inserted	Insert a CD, label facing up
	CD is badly scratched	Use another CD
	CD is dirty	Clean the CD
Batteries are empty	Change/recharge the batteries	
<b>Hum or noise in-car</b>	Unfit car radio input jack	Use the adapter cassette





# TROUBLESHOOTING

*Under no circumstances should you try to repair the unit yourself, as this will invalidate the warranty.*

English

<b>Problem</b>	<b>Possible cause</b>	<b>Remedy</b>
<b>No sound or bad sound quality</b>	Loose or wrong connections	Check connections
	Volume is not turned up	Adjust the volume
	Headphones worn the wrong way	Pay attention to the <b>L</b> (left) and <b>R</b> (right) indications
	Headphone plug is dirty	Clean the headphone plug
	Strong magnetic fields near the CD player	Change the player's position or connections
	Electrostatic discharge from the user via the CD player	Press ◀◀ or ▶▶ once or press <b>PLAY ▶/SHUFFLE</b> twice
<b>In-car use</b>		
	Strong vibrations	Find another place for the set
	Adapter cassette is incorrectly inserted	Insert the adapter cassette correctly
	Temperature inside car is too high/low	Let the CD player acclimatize
	Cigarette lighter/jack is too dirty	Clean the cigarette lighter/jack
	Wrong playback direction of the auto reverse feature of the car cassette player	Change the auto reverse direction

# Australia

---

## **Guarantee and Service valid for Australia**

The benefits given to the purchaser by this warranty are in addition to all other rights and remedies, which, under the Trade Practices Act or other Commonwealth or State law, the purchaser or owner has in respect of the product.

The Philips product carries the following warranties:

- C-series HiFi-systems 12 months.
- Compact Disc Players: 12 months.
- Home Audio Systems: 6 months.
- Clock radios, portable radios, cassette recorders, cassette players and radio recorders: 90 days.

Any defect in materials or workmanship occurring within the specified period from the date of delivery, will be rectified free of charge by the retailer from whom this product was purchased.

**Note:** Please retain your purchase docket to assist prompt service.

## **Conditions of this warranty**

1. All claims for warranty service must be made to the retailer from whom this product was purchased. All transport charges incurred in connection with warranty service or replacement will be paid by the purchaser.
2. These warranties do not cover batteries and extend only to defects in materials or workmanship occurring under normal use of the product where operated in accordance with our instructions.

**Philips Consumer Products Division  
Technology Park  
Figtree Drive, Australia Centre  
Homebush 2140  
New South Wales**

# New Zealand

---

## **Guarantee and Service for New Zealand**

Thank-you for purchasing this quality Philips product.

Philips New Zealand Ltd guarantees this product against defective components and faulty workmanship for a period of 12 months. Any defect in materials or workmanship occurring within 12 months from the date of purchase subject to the following conditions will be rectified free of charge by the retailer from whom this product was purchased.

## **Conditions**

1. The product must have been purchased in New Zealand. As proof of purchase, retain the original sales docket indicating the date of purchase.
2. The guarantee applies only to faults caused by defective components, or faulty workmanship on the part of the manufacturer.
3. The guarantee does not cover failures caused by misuse, neglect, normal wear and tear, accidental breakage, use on the incorrect voltage, use contrary to operating instructions, or unauthorised modification to the product or repair by an unauthorised technician.
4. Reasonable evidence (in the form of a sales docket) must be supplied to indicate that the product was purchased no more than 12 months prior to the date of your claim.
5. In the event of a failure, Philips shall be under no liability for any injury, or any loss or damage caused to property or products other than the product under guarantee.

This guarantee does not prejudice your rights under common law and statute, and is in addition to the normal responsibilities of the retailer and Philips.

## **How to claim**

Should your Philips product fail within the guarantee period, please return it to the retailer from whom it was purchased. In most cases the retailer will be able to satisfactorily repair or replace the product.

However, should the retailer not be able to conclude the matter satisfactorily, or if you have other difficulties claiming under this guarantee, please contact

**The Guarantee Controller  
Philips New Zealand Ltd.**

✉ **P.O. Box 41.021**

**Auckland**

☎ **(09) 84 94 160**

fax ☎ **(09) 84 97 858**



**CLASS 1  
LASER PRODUCT**

