

Register your product and get support at  
[www.philips.com/welcome](http://www.philips.com/welcome)

AZ5741/55



# User manual

**PHILIPS**

# Contents

|   |    |                              |    |
|---|----|------------------------------|----|
| <b>1 Important</b>                              | 2  | <b>7 Other features</b>      | 18 |
| Safety  | 2  | Listen through headphone     | 18 |
| Notice  | 3  |                              |    |
| <b>2 Your DVD Soundmachine</b>                  | 5  | <b>8 Product information</b> | 19 |
| Introduction                                    | 5  | Specifications               | 19 |
| What's in the box                               | 5  | Supported MP3 disc formats   | 19 |
| Overview of the main unit                       | 5  | USB playability information  | 19 |
| Overview of the remote control                  | 6  | Maintenance                  | 20 |
| <b>3 Get started</b>                            | 8  | <b>9 Troubleshooting</b>     | 21 |
| Install remote control batteries                | 8  |                              |    |
| Connect TV                                      | 8  |                              |    |
| Connect power                                   | 9  |                              |    |
| Turn on   | 9  |                              |    |
| Find the correct viewing channel                | 9  |                              |    |
| Select TV system that match the<br>connected TV | 9  |                              |    |
| Change system menu language                     | 10 |                              |    |
| <b>4 Play</b>                                   | 11 |                              |    |
| Play disc                                       | 11 |                              |    |
| Play from USB                                   | 12 |                              |    |
| Listen to a radio station                       | 12 |                              |    |
| <b>5 Play options</b>                           | 13 |                              |    |
| Adjust volume                                   | 13 |                              |    |
| Mute sound                                      | 13 |                              |    |
| Select repeat mode                              | 13 |                              |    |
| Search by time or chapter/track number          | 13 |                              |    |
| Display play information                        | 13 |                              |    |
| Preview pictures                                | 13 |                              |    |
| Zoom in/out image                               | 13 |                              |    |
| Rotate picture                                  | 14 |                              |    |
| Change the audio channel                        | 14 |                              |    |
| <b>6 Adjust settings</b>                        | 15 |                              |    |
| System Setup                                    | 15 |                              |    |
| Language Setup                                  | 16 |                              |    |
| Audio setup                                     | 16 |                              |    |
| Video setup                                     | 16 |                              |    |

# 1 Important

---

## Safety

---

### Important Safety Instructions

- ① Read these instructions.
- ② Keep these instructions.
- ③ Heed all warnings.
- ④ Follow all instructions.
- ⑤ Do not use this apparatus near water.
- ⑥ Clean only with dry cloth.
- ⑦ Do not block any ventilation openings. Install in accordance with the manufacturer's instructions.
- ⑧ Do not install near any heat sources such as radiators, heat registers, stoves, or other apparatus (including amplifiers) that produce heat.
- ⑨ Protect the power cord from being walked on or pinched, particularly at plugs, convenience receptacles, and the point where they exit from the apparatus.
- ⑩ Only use attachments/accessories specified by the manufacturer.
- ⑪ Use only with the cart, stand, tripod, bracket, or table specified by the manufacturer or sold with the apparatus. When a cart is used, use caution when moving the cart/apparatus combination to avoid injury from tip-over.
- ⑫ Unplug this apparatus during lightning storms or when unused for long periods of time.
- ⑬ Refer all servicing to qualified service personnel. Servicing is required when the apparatus has been damaged in any way, such as power-supply cord or plug is damaged, liquid has been spilled or objects have fallen into the apparatus, the apparatus has been exposed to rain or moisture, does not operate normally, or has been dropped.
- ⑭ **Battery usage CAUTION** – To prevent battery leakage which may result in bodily injury, property damage, or damage to the unit:
  - Install all batteries correctly, + and - as marked on the unit.
  - Do not mix batteries (old and new or carbon and alkaline, etc.).
  - Remove batteries when the unit is not used for a long time.
- ⑮ Apparatus shall not be exposed to dripping or splashing.
- ⑯ Do not place any sources of danger on the apparatus (e.g. liquid filled objects, lighted candles).
- ⑰ Where the MAINS plug or an appliance coupler is used as the disconnect device, the disconnect device shall remain readily operable.



#### Warning

- Never remove the casing of this apparatus.
- Never lubricate any part of this apparatus.
- Never place this apparatus on other electrical equipment.
- Keep this apparatus away from direct sunlight, naked flames or heat.
- Ensure that you always have easy access to the power cord, plug or adaptor to disconnect this apparatus from the power.

---

## Hearing safety

### Listen at a moderate volume.

- Using headphones at a high volume can impair your hearing. This product can produce sounds in decibel ranges that may cause hearing loss for a normal person, even for exposure less than a minute. The higher decibel ranges are offered for those that may have already experienced some hearing loss.
- Sound can be deceiving. Over time your hearing 'comfort level' adapts to higher volumes of sound. So after prolonged listening, what sounds 'normal' can actually be loud and harmful to your hearing. To guard against this, set your volume to a safe level before your hearing adapts and leave it there.

### To establish a safe volume level:

- Set your volume control at a low setting.
- Slowly increase the sound until you can hear it comfortably and clearly, without distortion.

### Listen for reasonable periods of time:

- Prolonged exposure to sound, even at normally 'safe' levels, can also cause hearing loss.
- Be sure to use your equipment reasonably and take appropriate breaks.

### Be sure to observe the following guidelines when using your headphones.

- Listen at reasonable volumes for reasonable periods of time.
- Be careful not to adjust the volume as your hearing adapts.
- Do not turn up the volume so high that you can't hear what's around you.
- You should use caution or temporarily discontinue use in potentially hazardous situations.

---

## Notice

Any changes or modifications made to this device that are not expressly approved by Philips Consumer Lifestyle may void the user's authority to operate the equipment.

---

## Disposal of your old product and batteries



Your product is designed and manufactured with high quality materials and components, which can be recycled and reused.

Never dispose of your product with other household waste. Please inform yourself about the local rules on the separate collection of electrical and electronic products and batteries. The correct disposal of these products helps prevent potentially negative consequences on the environment and human health.

Your product contains batteries, which cannot be disposed of with normal household waste. Please inform yourself about the local rules on separate collection of batteries. The correct disposal of batteries helps prevent potentially negative consequences on the environment and human health.

Please visit [www.recycle.philips.com](http://www.recycle.philips.com) for additional information on a recycling center in your area.

### Environmental information

All unnecessary packaging has been omitted. We have tried to make the packaging easy to separate into three materials: cardboard (box), polystyrene foam (buffer) and polyethylene (bags, protective foam sheet.)

Your system consists of materials which can be recycled and reused if disassembled by a specialized company. Please observe the local regulations regarding the disposal of packaging materials, exhausted batteries and old equipment.

Recording and playback of material might require consent. See Copyright Act 1956 and The Performer's Protection Acts 1958 to 1972.



The making of unauthorized copies of copy-protected material, including computer programs, files, broadcasts and sound recordings, may be an infringement of copyrights and constitute a criminal offence. This equipment should not be used for such purposes.



'DVD Video' is a trademark of DVD Format/ Logo Licensing Corporation.



Manufactured under license from Dolby Laboratories. Dolby and the double-D symbol are trademarks of Dolby Laboratories.

**This apparatus includes this label:**



 Note

- The type plate is located on the bottom of the product.

# 2 Your DVD Soundmachine

Congratulations on your purchase, and welcome to Philips! To fully benefit from the support that Philips offers, register your product at [www.philips.com/welcome](http://www.philips.com/welcome).

## Introduction

With this unit, you can enjoy:

- Video from DVD/VCD/SVCD or USB devices.
- Audio from discs, radio, or USB devices.
- Pictures from Kodak/JPEG discs, or USB devices.

The unit supports the following media formats:

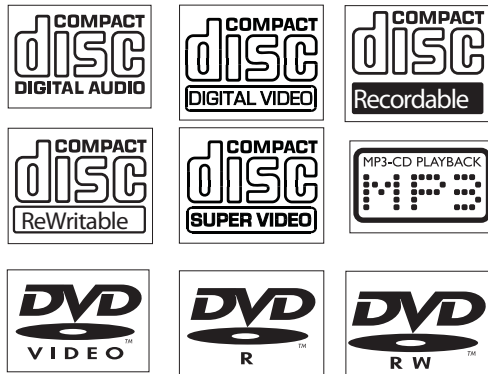

### Region code

This player can play discs with the following region code.

| DVD region code   | Countries     |
|---|---------------|
|  | Latin America |

## What's in the box



Check and identify the contents of your package:

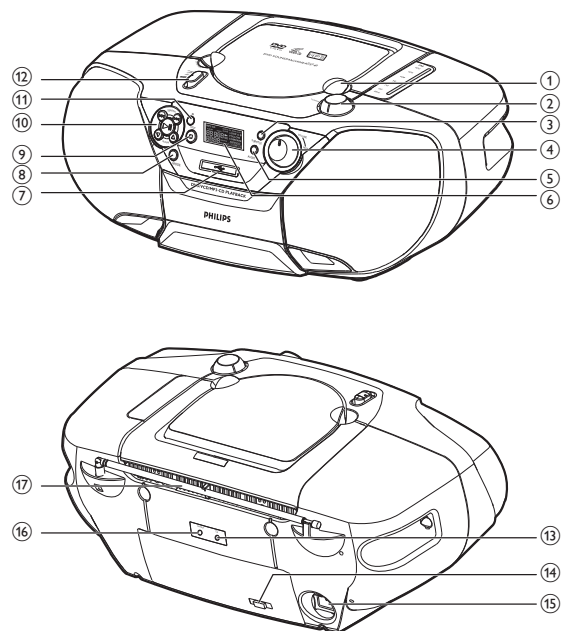

- Main unit
- Remote control
- AC power cord
- Round-to-flat pin converter
- Composite AV cable
- User manual
- Quick start guide

## Overview of the main unit





- 1 LIFT TO OPEN**
  - Open/close the disc compartment.
- 2 TUNING**
  - Tune to radio stations.
- 3 SUBTITLE**
  - Select a subtitle language.
- 4 VOLUME**
  - Adjust volume.

- ⑤ **AUDIO**
  - For DVD, select an audio language.
  - For VCD/SVCD, select an audio channel
- ⑥ **Display panel**
  - Display current status.
- ⑦ 
  - Connect to USB storage device.
- ⑧ **MODE**
  - Select a play mode.
- ⑨ 
  - Stop a play.
- ⑩ 
  - Stop or start play.

**SEARCH**  





  - Skip to the previous/next track, title, or file.
  - Search within a track/disc/USB.

**ALBUM**  / 

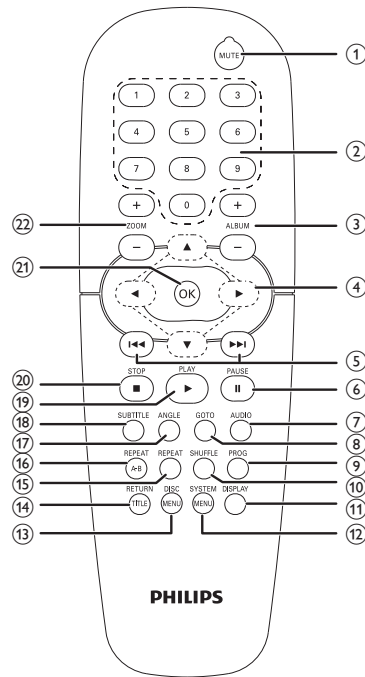
  - Skip to the previous/next album.
- ⑪ **IR**
  - The remote control sensor.
- ⑫ **Source selector**
  - Slide to turn off the unit, or select a source.
- ⑬ 
  - Connect to a headphone with 3.5-mm plug.
- ⑭ **Voltage selector**
  - Select a different voltage.
- ⑮ **AC MAINS**
  - Socket for the power cord.
- ⑯ **AV OUT**
  - Transmit audio and video signals to a connected device.
- ⑰ **FM antenna**
  - Improve FM reception.

## Overview of the remote control



- ① **MUTE**
  - Mute or restore volume.
- ② **Numeric keypad**
  - Select a track/title/file directly.
  - Input password.
- ③ **ALBUM +/-**
  - Skip to the previous/next album.
- ④ 
  - Navigate through the menu.
  - For JPEG discs, rotate the picture.
  - Pan through an enlarged picture up/down/left/right.
  - For DVD/MP3/VCD/SVCD/CD discs, press  /  to search backward or forward.
- ⑤ 
  - Skip to the previous/next track, title, or file.

- ⑥ **PAUSE ■■**
  - Pause or resume playback.
- ⑦ **AUDIO**
  - For DVD, select an audio language.
  - For VCD/SVCD, select an audio channel.
- ⑧ **GOTO**
  - For DVD/SVCD/VCD, go to the desired title, chapter or time.
  - For CD/MP3, go to the desired album/track.
- ⑨ **PROG**
  - Program tracks.
- ⑩ **SHUFFLE**
  - Play in randomly.
- ⑪ **DISPLAY**
  - Display current status.
  - For pictures, select a slide show mode.
- ⑫ **SYSTEM MENU**
  - Access/exit the system menu.
- ⑬ **DISC MENU**
  - For DVD, display the root menu.
  - For VCD/SVCD, enable or disable the PBC (playback control) feature.
- ⑭ **RETURN TITLE**
  - Return to the previous menu.
- ⑮ **REPEAT**
  - Select a repeat mode.
- ⑯ **REPEAT A-B**
  - Repeat a specific section within a track/disc.
- ⑰ **ANGLE**
  - Select an available viewing angle of a DVD.
- ⑱ **SUBTITLE**
  - Select a subtitle language.
- ⑲ **▶**
  - Start play.
- ⑳ **■**
  - Stop play.
- ㉑ **OK**
  - Confirm a selection.
- ㉒ **ZOOM +/-**
  - Zoom into or out of an image.



# 3 Get started

## ! Caution

- Use of controls or adjustments or performance of procedures other than herein may result in hazardous radiation exposure or other unsafe operation.

Always follow the instructions in this chapter in sequence.

If you contact Philips, you will be asked for the model and serial number of this product. The model number and serial number are on the bottom of the product. Write the numbers here:

Model No. \_\_\_\_\_

Serial No. \_\_\_\_\_

## Install remote control batteries

## ! Caution

- Risk of explosion! Keep batteries away from heat, sunshine or fire. Never discard batteries in fire.
- Risk of decreased battery life! Never mix different brands or types of batteries.
- Risk of product damage! When the remote control is not used for long periods, remove the batteries.

- 1 Open the battery compartment.
- 2 Insert 2 AA batteries with correct polarity (+/-) as indicated.
- 3 Close the battery compartment.

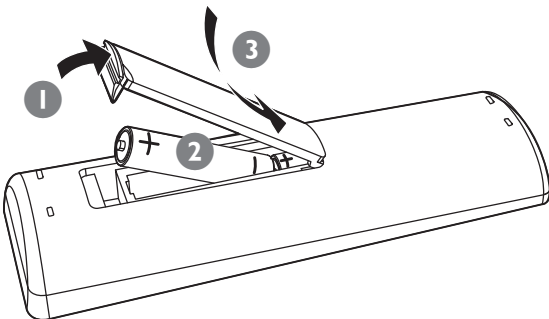

## Connect TV

- 1 Connect the black plug of the supplied video cable to the **AV OUT** socket on this unit.
- 2 Connect the yellow plug to the video input socket on the TV.
- 3 Connect the red plug to the audio input socket marked "R" (for right audio channel).
- 4 Connect the white plug to the audio input socket marked "L" (for left audio channel).

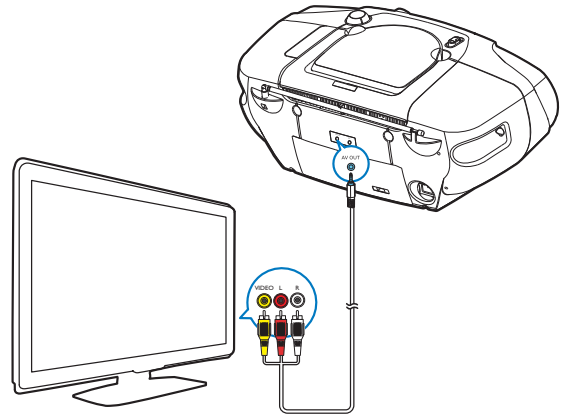

## Connect power

### ! Caution

- Risk of product damage! Make sure that the power supply voltage corresponds to the voltage printed on the bottom of the unit.
- The type plate is located on the bottom of the main unit.
- Before connecting the AC power cord, make sure you have completed all other connections.

- 1 Switch the voltage selector at the back of the unit to the local power line voltage.
- 2 Connect the AC power cable to:
  - the main unit.
  - the wall socket.

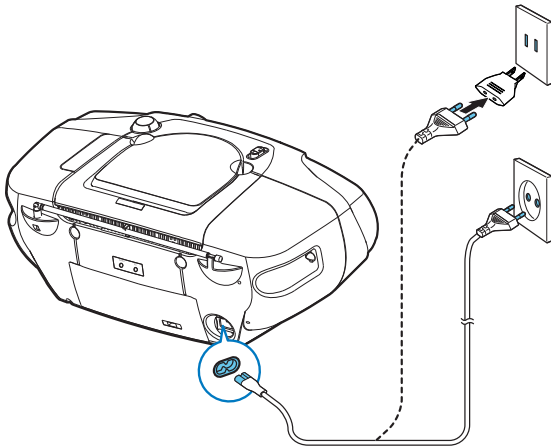

## Turn on

Slide the **source selector** on the main unit to **DISC/USB/FM**.

## Turn off

Slide the **source selector** on the main unit to **OFF**.

## Find the correct viewing channel

- 1 Slide the **source selector** to **DISC**.
- 2 Turn on the TV and switch to the correct video-in channel in one of the following ways:
  - Go to the lowest channel on your TV, then press the Channel Down button until you see the blue screen.
  - Press the source button repeatedly on the remote control of your TV.

### \* Tip

- The video-in channel is between the lowest and highest channels and may be called FRONT, A/V IN, VIDEO etc. See the TV user manual on how to select the correct input on the TV.

## Select TV system that match the connected TV

This DVD player is compatible with both NTSC and PAL. For the playback of a DVD disc on this DVD soundmachine, the color systems of the TV set and DVD player should match.

- 1 Press **SYSTEM MENU**.
- 2 Select **[SYSTEM SETUP] > [TV SYSTEM]**, and then press **▶**.
- 3 Press **▼ / ▲** to select one of the options below and then press **OK**.

|               |                                     |
|---------------|-------------------------------------|
| <b>[NTSC]</b> | For TV with NTSC color system.      |
| <b>[PAL]</b>  | For TV with PAL color system.       |
| <b>[AUTO]</b> | For TV with multiple color systems. |

- 4 Press **SYSTEM MENU** to exit.

---

## Change system menu language

- 1 Press **SYSTEM MENU**.
- 2 Press ◀ / ▶ to select **[LANGUAGE SETUP]** page, and then press ▼.
- 3 Press ▼ / ▲ keys to highlight one of the options below, and then press ▶.
  - **[OSD LANGUAGE]**: Select a language for on-screen display.
  - **[MENU LANG]**: Select a language for disc menu.
- 4 Press ▼ / ▲ keys to select a language and press **OK**.
- 5 Press **SYSTEM MENU** to exit the menu.



### Note

- Depending on the DVD or VIDEO CD, some operations may be different or restricted.
- If the "INVALID KEY" appears on the TV screen when a button is pressed, it means the function is not available on the current disc or at the current time.

# 4 Play

---

## Play disc

- 1 Slide the **source selector** on the main unit to **DISC**.
- 2 Lift to open the disc compartment.
- 3 Insert a disc with the printed side facing up, and then close the disc compartment.
- 4 Press **▶** to start play.
  - To pause/resume play, press **PAUSE ■■**.
  - To stop play, press **■**.
  - To skip to a track, press **◀◀ / ▶▶**.
  - To search within a track/disc, press and hold **◀ / ▶**, then release to resume normal play.

---

## Use the disc menu

When you load a (S)VCD disc, a menu may be displayed on the TV screen.

To access or exit the menu manually:

- 1 Press **DISC MENU**.

**For VCD with PlayBack Control (PBC) feature (version 2.0 only):**

With the PBC feature, you can play VCD interactively according to the menu screen.

- 1 During play, press **DISC MENU** to enable/disable PBC.
  - ↳ When PBC is enabled, the menu screen is displayed.
  - ↳ When PBC is disabled, normal play is resumed.
  - To return to the previous menu, press **RETURN**.

For DVD

- 1 During playback, press **DISC MENU** to return to disc menu.
  - ↳ If the current disc/title has a menu, the menu is displayed on the screen. Otherwise, the disc menu is displayed.
- 2 Press **▲ / ▼ / ◀ / ▶** to select the desired title or chapter, and then press **▶** or **OK** to start play.

---

## Select an audio language

You can select an audio language on DVDs with multiple sound tracks or VCDs with multiple audio channels.

- 1 During play, press **AUDIO** repeatedly to select an audio language for DVD, or audio channel for VCD/SVDC.



Tip

- If the selected audio channel is unavailable, the default audio channel is used.

---

## Select a subtitle language

You can select a subtitle language only on DVDs.







- During play, press repeatedly **SUBTITLE** to select a subtitle language.  
↳ The feature is disc dependant.

---

## Play from USB

### Note

- Make sure that the USB device contains playable audio contents for supported formats. (See "USB playability information")

- 1 Flip open the USB socket cover.
- 2 Plug the USB device into the  socket.
- 3 Slide the **source selector** to **USB**.
- 4 Press  to start play.
  - To pause/resume play, press **PAUSE** .
  - To stop play, press .
  - To search within an audio file, press and hold  / , then release to resume normal play.

---

## Listen to a radio station

### Tip

- Position the antenna as far as possible from TV,VCR or other radiation source.
- For optimal reception, fully extend the antenna and adjust its position.

- 1 Slide the **source selector** on the main unit to **FM**.
- 2 Turn **TUNING** to tune to a radio station.

# 5 Play options

---

## Adjust volume

During play, turn **VOLUME** to increase/decrease the volume level.

## Mute sound

During play, press **MUTE** to mute/restore sound.

## Select repeat mode

During play, press **REPEAT** repeatedly to select different repeat mode.

### To repeat a specific section,

- 1 During play, press **REPEAT A-B** at the start point.
  - 2 Press **REPEAT A-B** again at the end point.
    - ↳ The selected section starts to play repeatedly.
- To resume normal play, press **REPEAT A-B** again.



Tip

- The section from A to B can be set only within the same track.

---

## Search by time or chapter/ track number

- 1 During video/audio play, press **GOTO** until a time field or track field is displayed.
  - For the time field, enter the point to start in hour, minute and second.
  - For the track field, enter the track number.
  - ↳ Play starts automatically at your selected point.

---

## Display play information

During play, press **DISPLAY** repeatedly.

---

## Preview pictures

- 1 During play, press **■**.
  - ↳ Play stops and content in the current folder are displayed.
- 2 Press **▲ / ▼** to select a picture that you want to preview.

---

## Zoom in/out image

- 1 During video play, press **ZOOM+/-** repeatedly to zoom into/out of the image.

---

## Rotate picture

- 1 During play, press ▲ / ▼ to flip the picture vertically or horizontally.
- 2 Press ◀ / ▶ to rotate the picture anti-clockwise or clockwise.

---

## Change the audio channel

During play, press **AUDIO** repeatedly to select an available audio channel.

- Mono Left
- Mono Right
- Stereo

# 6 Adjust settings

To maximize your play experience, use **SYSTEM MENU** to fine tune your settings.

- 1 Press **SYSTEM MENU**.  
↳ The system menu is displayed.
- 2 Press **▲ / ▼** or **◀ / ▶** to navigate through the menu and press **▶** to select an option.
- 3 press **OK** to confirm.
- 4 Press **RETURN** to go back to previous menu level.
- 5 Press **SYSTEM MENU** to exit.



## Tip

- Some of the features in the System Menu Options are described in "Get Started".

---

## System Setup

On the **[SYSTEM SETUP]** page, you can set the following options:

### **[SCREEN SAVER]**

Turn on or off the screen saver mode. It helps to protect the TV screen from being damaged due to over exposure to static image for being too long.

- **[ON]** - Set the screen saver active after 10 minutes of inactivity (for example, in the pause or stop mode)
- **[OFF]**- Disable screen saver mode.

### **[PICTURE MUSIC]**

To turn on/off the background music.

- **[ON]** - Select a track first and then select a picture. The picture is displayed with background music.
- **[OFF]** - The picture is displayed without background music.

### **[SLIDE TIME]**

Set the time interval between two sequential pictures in a slide show.

### **[PASSWORD]**

You can change the four-digit code used as Password.

- 1 Use the numeric keys (**0-9**) to enter your current four-digit code, then press **OK**.  
The password supplied by default is **0000**.
- 2 Press **▶**, then enter the new four-digit password.
- 3 press **OK** to confirm.



## Note

- If you forget the password, enter '0000' before you set a new password.

### **[RATING]**

Restricts access to discs that are unsuitable for children. These types of discs must be recorded with ratings.

- 1 Go to **[PASSWORD]** to enter the password.
- 2 Go to **[RATING]** and press **▶**.
- 3 Select a rating level, then press **OK**.
- 4 Press the numeric keys (**0-9**) to enter the password.

### **Rating explanations**

|                     |   |
|---------------------|---|
| <b>[1 KID SAFE]</b> | Kids material; recommended especially for children and viewers of all ages. |
| <b>[2 G]</b>        | General Audience; recommended as acceptable for viewers of all ages.        |
| <b>[3 PG]</b>       | Parental Guidance suggested.  |
| <b>[4 PG13]</b>     | Material is unsuitable for children under age 13.                           |
| <b>[5 PG-R]</b>     | Recommend parents to restrict children under 17 to view.                    |
| <b>[6 R]</b>        | Restricted. Recommend parent to guide children under 17 to view.            |
| <b>[7 NC-17]</b>    | No children under age 17; not recommended for children under age 17.        |



---

**[8 ADULT]** material for adults only; viewed only by adults due to graphic sexual scenes, violence, or language.

---

 **Note**

- Rated discs above the level you set in **[RATING]** require a password to be played.
- The ratings are country-dependent. To allow all discs to play, select **[8 ADULT]**.
- Some discs have ratings printed on them but are not recorded with ratings. This function has no effect on such discs.

**[DEFAULT]**

Resets all the settings of this unit to factory default, except for the password and parental settings.

---

## Language Setup

On the **[LANGUAGE SETUP]** page, you can set the following options:

**[OSD LANGUAGE]**

Select the preferred language for on-screen display.

**[MENU LANG]**

Select the preferred language for disc menu.

---

## Audio setup

On the **[AUDIO SETUP]** page, you can set the following options:

**[DOWNMIX]**

This option is for speaker setup and can only be setup under disc mode.

- **[LT/RT]**: Select this option if your DVD player is connected to a Dolby Pro Logic decoder.
- **[STEREO]**: Select this when output delivers sound from only the two front speakers.

**[NIGHT MODE]**

Make loud sound level softer and soft sound level louder so that you can watch the DVD movies at a low volume, without disturbing others.

- **[ON]** – enjoy quiet viewing at night (DVDs only).
- **[OFF]** – enjoy surround sound with its full dynamic range.

**[DYNAMIC RANGE]**

Select the Dynamic Rang to fit the individual listening situation of the audience. The variable range is from FULL, 6/8~2/8 or OFF.

---

**[FULL]** Audio with fully compressed Dynamic Range.

---

**[6/8~2/8]** Audio with partially compressed Dynamic Range.

---

**[OFF]** Audio with uncompressed Dynamic Range.

---

---

## Video setup

On the **[VIDEO SETUP]** page, you can set the following options:

**[TV SYSTEM]**

Change this setting if the video does not appear correctly. By default, this setting matches the most common setting for TVs in your country.

---

**[NTSC]** For TV with NTSC color system.

---

**[PAL]** For TV with PAL color system.

---

**[AUTO]** For TV that is compatible with both PAL and NTSC.

---

**[TV TYPE]**

The TV format determines the aspect ratio of display according to the type of TV you have connected.



4:3 Pan Scan (PS)



4:3 Letter Box (LB)



16:9 (Wide Screen)

---

**[4:3PS](pan scan)** If you have a normal TV and want both sides of the picture to be trimmed or formatted to fit your TV screen.

---

**[4:3LB]**  
(letter box) If you have a normal TV. In this case, a wide picture with black bands on the upper and lower portions of the TV screen will be displayed.

---

**[16:9]**  
(wide screen) If you have a widescreen TV.

---

# 7 Other features

---

## Listen through headphone

- 1 Plug a headphone into the  socket on the unit.

# 8 Product information

## Note

- Product information is subject to change without prior notice.

## Specifications

### Disc

|                           |  |
|---------------------------|--|
| Laser Type                | Semiconductor  |
| Disc Diameter             | 12 cm/8 cm   |
| Support Disc              | DVD, DVD-RW, DVD-R, CD-DA, CD-R, CD-RW, MP3-CD, WMA-CD |
| Audio DAC                 | 24 Bits / 44.1 kHz                                     |
| Total Harmonic Distortion | <1%  |
| Frequency Response        | 60 Hz -16 kHz  |
| S/N Ratio                 | >62 dBA  |

### FM

|                           |                 |
|---------------------------|-----------------|
| Tuning Range              | 87.5 - 108 MHz; |
| Tuning grid               | 50 kHz          |
| Total Harmonic Distortion | <3%             |
| Signal to Noise Ratio     | >50 dB          |

### General

|                    |                                       |
|--------------------|---------------------------------------|
| Rated output power | 4 W RMS                               |
| Power supply       | Input: 110-127 V, 220-240 V; 50/60 Hz |

|                             |             |
|-----------------------------|-------------|
| Operation Power Consumption | 15 W        |
| Standby Power Consumption   | ≤ 1.2 W     |
| Dimensions                  | 401 X 172 X |
| - Main Unit (W x H x D)     | 243 mm      |
| Weight                      | 2.5 kg      |

## Supported MP3 disc formats

- ISO9660, Joliet
- Maximum title number: 512 (depending on file name length)
- Maximum album number: 255
- Supported sampling frequencies: 32 kHz, 44.1 kHz, 48 kHz
- Supported Bit-rates: 32~256 (kbps), variable bit rates

## USB playability information

### Compatible USB devices:

- USB flash memory (USB 2.0 or USB1.1)
- USB flash players (USB 2.0 or USB1.1)
- memory cards (requires an additional card reader to work with this apparatus)

### Supported formats:

- USB or memory file format FAT12, FAT16, FAT32 (sector size: 512 bytes)
- MP3 bit rate (data rate): 32-320 Kbps and variable bit rate
- WMA v9 or earlier
- Directory nesting up to a maximum of 8 levels
- Number of albums/ folders: maximum 99
- Number of tracks/titles: maximum 999
- ID3 tag v2.0 or later
- File name in Unicode UTF8 (maximum length: 128 bytes)

### Unsupported formats:

- Empty albums: an empty album is an album that does not contain MP3/WMA files, and is not be shown in the display.
- Unsupported file formats are skipped. For example, Word documents (.doc) or MP3 files with extension .dlf are ignored and not played.
- AAC, WAV, PCM audio files
- DRM protected WMA files (.wav, .m4a, .m4p, .mp4, .aac)
- WMA files in Lossless format

---

## Maintenance

### Clean the cabinet

- Use a soft cloth slightly moistened with a mild detergent solution. Do not use a solution containing alcohol, spirits, ammonia or abrasives.

### Clean discs

- When a disc becomes dirty, clean it with a cleaning cloth. Wipe the disc from the centre out.

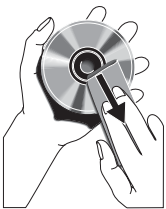

- Do not use solvents such as benzene, thinner, commercially available cleaners, or antistatic spray intended for analogue records.

### Clean the disc lens

- After prolonged use, dirt or dust may accumulate at the disc lens. To ensure good play quality, clean the disc lens with Philips CD lens cleaner or any commercially available cleaner. Follow the instructions supplied with cleaner.

# 9 Troubleshooting



## Warning

- Never remove the casing of this apparatus.

To keep the warranty valid, never try to repair the system yourself.

If you encounter problems when using this apparatus, check the following points before requesting service. If the problem remains unsolved, go to the Philips web site ([www.philips.com/welcome](http://www.philips.com/welcome)). When you contact Philips, ensure that the apparatus is nearby and the model number and serial number are available.

### No power/No sound

- Ensure that the AC power plug of the unit is connected properly.
- Ensure that there is power at the AC outlet.
- Ensure that the batteries are installed correctly.
- Adjust the volume.
- The file is a non-audio one. Select an audio file.

### No picture

- Check the video connection.
- Turn on the TV to the correct Video-In channel.
  - ↳ This channel is usually near channel 00. Or, you may have a button on the TV remote control that selects Auxiliary or A/V IN channel. See your TV owner's manual for details. Or, change channels at the TV until you see DVD screen on the TV.
- Progressive scan is activated but the TV does not support progressive scan.

### Black and white or distorted picture

- The disc does not match the TV color system standard (PAL/NTSC).
- Sometimes a slight picture distortion may appear. This is not a malfunction.
- Clean the disc.
- A distorted picture may appear during progressive scan setup.

### No disc detected

- Insert a disc.
- Check if the disc is inserted with the print side facing inward.
- Wait until the moisture condensation at the lens has cleared.
- Replace or clean the disc.
- Use a finalized CD or correct format disc.

### No response from the unit

- Disconnect and reconnect the AC power plug, then turn on the unit again.

### The aspect ratio of the TV screen cannot be changed even though you have set the TV display format.

- The aspect ratio is fixed on the loaded DVD disc.
- The aspect ratio may not be possible to change for some TV systems.

### Disc does not play

- Insert a readable disc and ensure that the label side faces up.
- Check the disc type, color system and regional code. Check for any scratches or smudges on the disc.
- Press **SETUP** to exit the system setup menu.
- Disable the password for parental control or change the rating level.
- Moisture has condensed inside the system. Remove the disc and leave the system turned on for about an hour. Disconnect and reconnect the AC power plug, and then turn on the system again.

### Poor radio reception

- Increase the distance between the unit and your TV or VCR.
- Fully extend and adjust the FM antenna.

### Audio or subtitle languages cannot be set

- The disc is not recorded with sound or subtitles in multiple languages.
- The audio or subtitle language setting is prohibited on the disc.

### Cannot display some files in USB device

- The number of folders or files in the USB device has exceeded a certain limit. This phenomenon is not a malfunction.
- The formats of these files are not supported.

### USB device not supported

- The USB device is incompatible with the unit. Try another one.

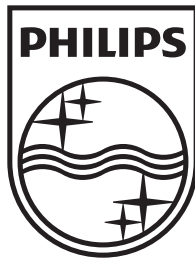

Specifications are subject to change without notice  
© 2012 Koninklijke Philips Electronics N.V.  
All rights reserved.

AZ5741\_55\_UM\_V1.0

