

# PHILIPS

AZ 2415 Portable CD Micro System



Instructions for use  
Mode d'emploi  
Instrucciones de manejo  
使用説明書



# PHILIPS

**(AUS) Australia**

Guarantee.....Page 60

**(NZ) New Zealand**

Guarantee.....Page 60

**(MEX) México**

**NOM**

Garantía.....Página 61

Es necesario que lea cuidadosamente su instructivo de manejo.

	<b>PRECAUCIÓN - ADVERTENCIA</b> No abrir, riesgo de choque eléctrico	
	<b>ATENCIÓN</b> Verifique que el voltaje de alimentación sea el requerido para su aparato	
Para evitar el riesgo de choque eléctrico, no quite la tapa. En caso de requerir servicio, dirijase al personal calificado.		

**NOM**

**(BR) Brasil**

Garantía.....Página 61-62

**English ..... 4**

**Français ..... 18**

**Español ..... 32**

**中文 ..... 46**

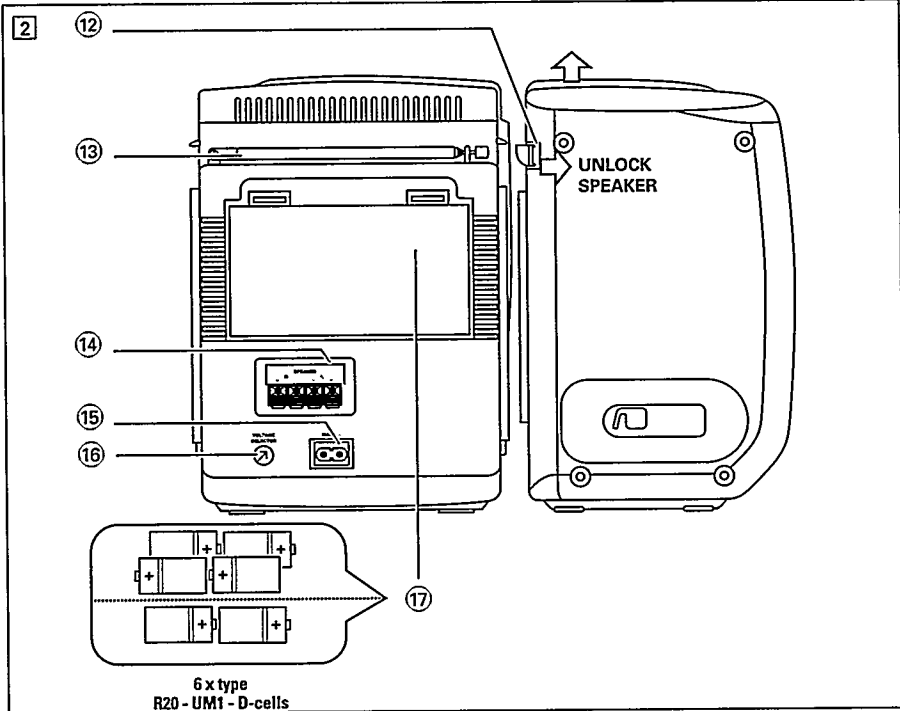
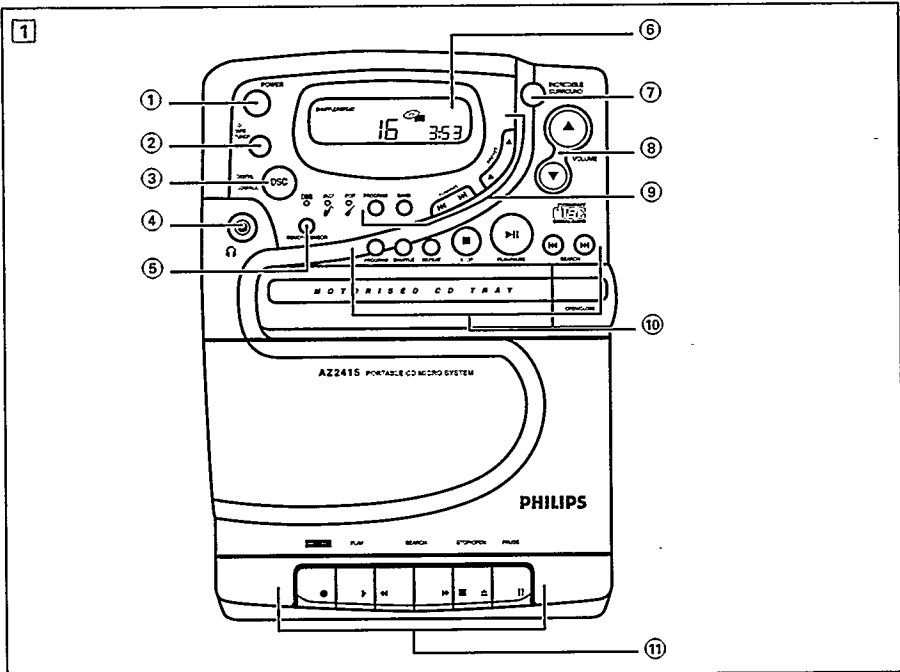

# CONTROLS

English

## FRONT PANEL

See fig. 1

- ① **POWER** - To switch the set on / off.
- ② **CD - TAPE - TUNER** - To select the sound source.
- ③ **DSC (DIGITAL SOUND CONTROL)** - To increase the bass level, (DYNAMIC BASS BOOST) or enhance the type of music you are listening to: DBB · JAZZ · POP.
- ④  - 3.5 mm headphone socket.
- ⑤ **REMOTE SENSOR** - Infrared remote sensor for remote control reception.
- ⑥ **Display** - to show the different play modes.
- ⑦ **INCREDIBLE SURROUND** - To create a superenhanced surround sound.
- ⑧ **VOLUME ▲ ▼** - To adjust the volume level.
- ⑨ **DIGITAL TUNER**  
**PRESET** - ◀ / ▶ (down / up)  
- To select a preset station.  
**Tuning** - ◀◀ / ▶▶ (down / up)  
- To tune to radio stations.  
**BAND**  
- To select the wave band (FM/AM).  
- To select 9/10 KHz tuning step for AM band (not all versions).  
**PROGRAM** - To programme preset stations.
- ⑩ **CD PLAYER**  
**OPEN / CLOSE** - To open / close the CD tray.  
**SEARCH** ◀◀ or ▶▶ - To skip or search backwards and forwards to a passage or a track.  
**PLAY•PAUSE** ▶|| - To start or interrupt CD playback.  
**STOP** ■ - To stop playback or erase a programme.  
**REPEAT** - To repeat a track, CD programme or an entire CD.  
**SHUFFLE** - To select playback of tracks in random order.  
**PROGRAM** - To programme tracks and to review the programme.

## FRONT PANEL

- ⑪ **CASSETTE RECORDER keys**  
**RECORD** ● - To start recording.  
**PLAY** ▶ - To start playback.  
**SEARCH** ◀◀ / ▶▶ - To fast rewind/wind the tape.  
**STOP•OPEN** ■ ▲ - To stop playback and open the cassette compartment.  
**PAUSE** || - To interrupt recording or playback.

## BACK PANEL

See fig. 2

- ⑫ **Speaker levers** - To unlock the loudspeaker boxes.
- ⑬ **Telescopic aerial** - To improve FM reception.
- ⑭ **Speakers** - Loudspeaker terminals.
- ⑮ **AC MAINS** - Socket for mains lead.
- ⑯ **Voltage selector**
- ⑰ **Battery door** - To open the battery compartment.

## REMOTE CONTROL

- ① **CD** - To select CD source.
- ② **PRESET** - ▼ / ▲ (down / up) - To select a preset station.
- ③ **0-9**
  - To key in a CD track number.
  - To key in a preset radio station.
- ④ **LONG PLAY** - Please note that this control has no corresponding function on this set.
- ⑤ **VOLUME** ▲ , ▼ - To adjust volume level.
- ⑥ **SEARCH** ◀ or ▶ - To skip or search a passage or a track.
- ⑦ **STOP** ■ - To stop playback or erase a programme.
- ⑧ **TUNER** - To select the tuner source.
- ⑨ **TRAY OPEN** - To open / close the CD tray.
- ⑩ **SHUFFLE** - To play a CD in random order.
- ⑪ **PLAY•PAUSE** ▶|| - To start or interrupt CD play.

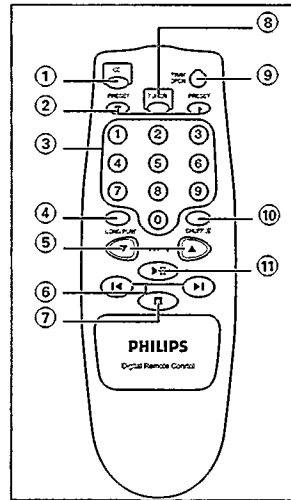

## BATTERIES

Whenever convenient, use the mains supply if you want to conserve battery life. Make sure you remove the mains plug from the set and wall socket before inserting batteries.

### Batteries (optional)

1. Open the battery compartment and insert as shown six batteries, type R20, UM1 or D-cells (preferably alkaline) with the correct polarity as indicated by the (+) and (-) symbols inside the compartment.

### Remote control batteries (included)

1. Open the battery compartment and insert as shown two batteries, type R03, UM4 or AAA (preferably alkaline).
  2. Replace the compartment door, making sure the batteries are firmly and correctly in place.
  3. Remove the batteries if exhausted or if they will not be used again for a long period.
- The incorrect use of batteries can cause electrolyte leakage and will corrode the compartment or cause the batteries to burst. Therefore:
    - Do not mix battery types, e.g. alkaline with zinc carbonate.
    - When inserting new batteries, replace all batteries at the same time.

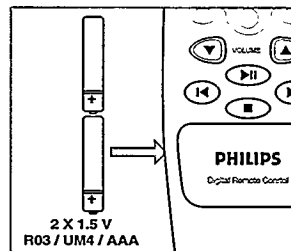
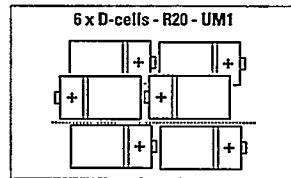

**Note:** The battery supply is switched off when the set is connected to the mains.

# POWER SUPPLY

English

## MAINS

1. Check if the mains voltage as shown on the type plate (on the base of the set) corresponds to your local mains voltage. If it does not, consult your dealer or service organisation.
2. If your set is equipped with a voltage selector, set it to the local mains voltage.
3. Connect the mains lead (packed inside the battery compartment) to the MAINS ~ socket and the wall socket.  
– The set is now ready to use.
4. To switch off the mains supply completely, pull the mains plug out of the wall socket.

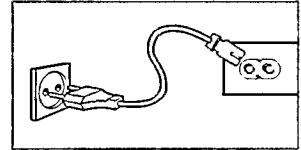

**Note:** The display lights up only if the set is connected to the AC mains power supply.

### Switching POWER on / off: Save energy

Whether you are using mains or battery supply, to avoid unnecessary energy consumption always push the POWER button to the off position after using the set.

When the set is switched off the last source selected, tuner presets, volume and sound settings will be retained in the set's memory.

### Environmental information

All redundant packaging material has been omitted. We have done our utmost to make the packaging easily separable into three mono materials: cardboard (box), expandable polystyrene (buffer) and polyethylene (bags, protective foam sheet).

**Your set consists of materials which can be recycled if disassembled by a specialized company. Please observe the local regulations regarding the disposal of packaging materials, exhausted batteries and old equipment.**

## REMOVABLE SPEAKERS

### Attaching the speakers

- Slide the speakers down into the sleeves on the sides of the set cabinet. The speakers will click into position.

### Taking off the speakers

- Keep the lever (found on the back corner of the speaker) pressed and slide the speaker upwards.

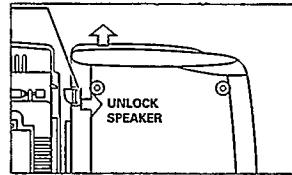

### Connecting the speakers

1. Connect the right speaker to the terminal R, with the red marked wire to (+) and the black wire to (-).
2. Clip the exposed portion of wire into the corresponding colour terminal.
3. Repeat the wiring procedure for the left speaker to terminal L, making sure that you connect the red marked wire to + and the black wire to -.

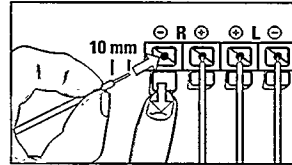

### Positioning the speakers

The ideal position is obtained when the 2 front speakers and the listening position build an equilateral triangle and the speakers are at ear-height.

**Note:** – Speakers with an impedance of 8 ohms or higher other than as supplied may be used instead. Do not, however, use speakers with a lower impedance as this will result in damage to your set.

- When headphones are connected to the headphone socket  the speakers are disconnected.

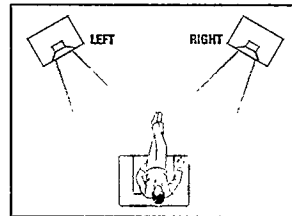

## GENERAL OPERATION

1. To switch on the set, press the POWER button.
2. To select your sound source press the CD - TAPE - TUNER button until the desired mode is shown in the display.
3. Adjust the volume using the VOLUME ▲, ▼ buttons.  
→ Display indication shows the level, 0-32 and VOL.
4. Adjust the sound effect by pressing the DSC button once or more.  
→ DBB, JAZZ or POP lights up when activated.
5. Create an enhanced surround sound by pressing the INCREDIBLE SURROUND button.  
→ The INCREDIBLE SURROUND button lights up when activated.
6. To switch off the set, always press POWER so that the sound and volume indicators do not remain lit after use.

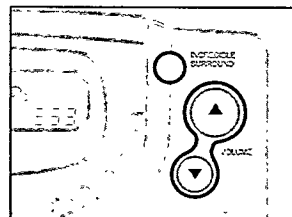
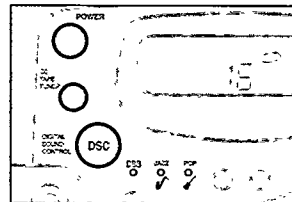

# DIGITAL TUNER

English

## TUNER

### AM tuning step (some versions only)

In North and South America the frequency step between adjacent channels in the AM band is 10 KHz. In the rest of the world this step is 9 KHz. Usually the frequency step has been preset in the factory for your area.

### To change the tuning step.

1. Press the POWER button to switch on the set.
  2. Keep the BAND selector pressed for 5 seconds or more.
    - The display shows either *9 Grid* or *10 Grid*.
- All preset stations will be lost and need to be programmed again if you decide to set the tuning step during use.

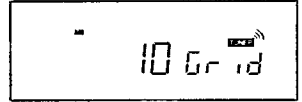
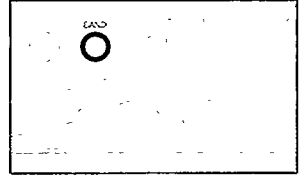

## TUNING TO RADIO STATIONS

1. Select TUNER using the CD-TAPE-TUNER button.
2. Press BAND to select your wave band.
  - Tune to radio stations, press TUNING control ◀◀ or ▶▶ on the set until the frequency on the display starts running, before releasing your finger from the control.
    - The radio automatically tunes to a station of sufficient reception and *Srch* appears on the display.
3. Repeat if necessary until you find the desired station.
  - Tune to a weak transmitter, briefly press TUNING ◀◀ or ▶▶ until you have found optimum reception or the correct frequency is shown on the display.
  - When STEREO appears on the display, you are receiving a FM-stereo transmitter.

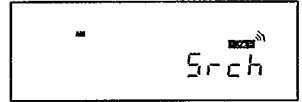
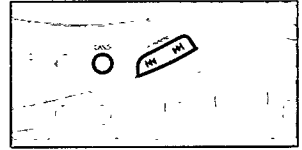

### To improve radio reception:

- For FM, pull out the telescopic aerial. Incline and turn the aerial. Reduce its length if the signal is too strong (very close to a transmitter).
- For AM, the set is provided with a built-in aerial so the telescopic aerial is not needed. Direct the aerial by turning the whole set.



## PROGRAMMING RADIO STATIONS

You can store up to 29 radio stations in the memory. When tuning to the preset station, the preset number (1 to 29) is indicated in the display.

1. Tune to a station, following the three steps given under **TUNING TO RADIO STATIONS**.  
→ If the frequency is already stored in the memory, the preset number will be displayed.
  2. Press PROGRAM to programme your desired station.  
→ PROGRAM will start flashing on the display.
  3. Press the PRESET control (up or down) to allocate a preset station number from 1 to 29.
  4. Press PROGRAM again to confirm the setting.
  5. Repeat the above four steps to store other frequencies and presets in the memory.
- You can clear a preset number by storing another frequency in its place.

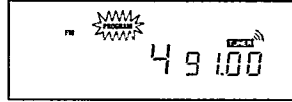
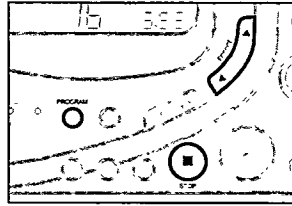

### Tuning to preset stations

There are three ways possible in which you can tune to preset stations:

- Press the PRESET ◀, ▶ control (down, up) on the set .
- By remote control, press ▼, ▲ (down , up) until the desired preset number appears on the display.
- By remote control, to directly key in the preset station: press TUNER and then ket in the number of your preset station using the digits 0–9.

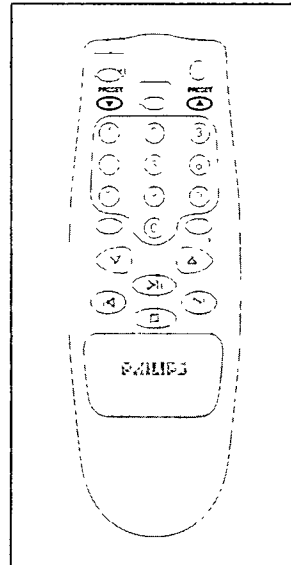

# CD PLAYER

English

## CD DISPLAY INDICATION

- **OPEN/CLOSE:** When you open / close the CD tray.
- **Total track number and playing time:** In stop position.
- **no diSC:** Error in CD operation or with the CD (see 'TROUBLESHOOTING').
- **Current track number and elapsed playing time:** During CD play.
  - In PAUSE position, the display freezes and the elapsed playing time flashes.
- **SHUFFLE/REPEAT (ALL):** When the respective mode is activated.
- **SElect:** When you activate PROGRAM prior to track selection
- **PROGRAM:** When programme function is active.
- **Pr and the number (1-20):** indicating the position of a track within a programme.
- **P:** (and a track number) indicates that a particular track has been programmed in STOP position
- **FULL:** Maximum track number stored.
- **CLEAR:** When you cancel a CD programme
- **Playing time and total number of programmed tracks:** in stop position or at the end of a CD programme.



## PLAYING A CD

1. Select CD mode using the CD-TAPE-TUNER button.
2. Press OPEN • CLOSE ▲ ■ on the set or on the remote control press CD and then TRAY OPEN to open the CD tray.
3. Insert the CD, printed side facing up and press OPEN • CLOSE ▲ ■ to close the CD tray.
4. Start playback by pressing PLAY • PAUSE ► II.
5. To interrupt playback, press PLAY • PAUSE ► II. Press PLAY • PAUSE ► II again to continue playback.
6. Press STOP ■ to stop CD playback.
7. To switch off the set press the POWER button.

**Note:** CD playback will also stop when:

- the CD tray is opened;
- the CD has reached the end;
- you press the POWER button;
- you change the sound source to TAPE or TUNER.

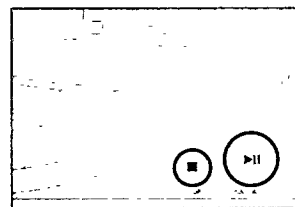

## SEARCH ◀◀ OR ▶▶

### Selecting a different track during playback

- You can jump to the next track by pressing SEARCH ▶▶ once. If you want to skip more than one track, press SEARCH ▶▶ more than once until the display shows the desired track number.
- If you want to repeat the current track from the beginning, press SEARCH ◀◀ once. If you want to repeat one of the previous tracks, press SEARCH ◀◀ more than once until the display shows the desired track number.

### Starting with a particular track

1. In the STOP position you can select a desired track using the SEARCH ◀◀ or ▶▶.
2. Press PLAY • PAUSE ▶|| to start playback.

### Searching for a passage within a track

You can search for a passage within a track. The CD is played at low volume and at high speed, however, the sound is still recognizable.

1. Keep the SEARCH ◀◀ or ▶▶ button pressed during playback, and release the button as soon as you recognize the desired passage:  
→ Normal CD playback will resume at this point.

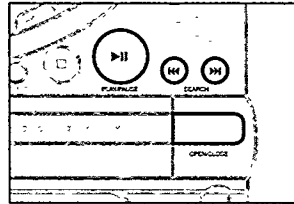

## SHUFFLE/REPEAT

Four different modes can be selected or changed before or during playback. The play modes can also be combined with PROGRAM.

1. Press REPEAT/SHUFFLE until the desired function appears on the display.

**SHUFFLE** - Tracks of the entire CD or the programme are played in random order.

**SHUFFLE REPEAT** - To repeat the CD or programme continuously in random order.

**REPEAT ALL** - Repeats the entire CD.

**REPEAT (SHUFFLE REPEAT)** - Plays the current (random) track continuously.

→ Except for REPEAT it is also possible to skip tracks by holding the SEARCH ◀◀ or ▶▶ control continuously until you reach your desired track.

2. To leave the SHUFFLE/REPEAT mode, press the respective SHUFFLE or REPEAT button repeatedly until the various SHUFFLE/REPEAT modes are no longer shown on the display. You can also press STOP ■ to quit playback.

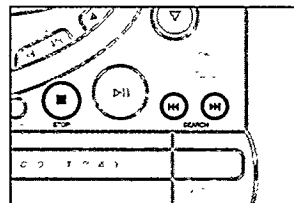
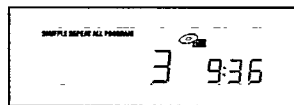

# CD PLAYER

English

## PROGRAMMING TRACK NUMBERS

Select and store up to 20 tracks in the programme memory in the desired sequence. You may store any track more than once. You can programme tracks in the STOP position or during playback.

- When the programme memory is full, the display will show FULL and it will not be possible to add further tracks to your current programme.

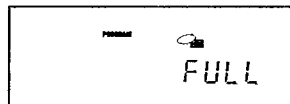

### Programming track numbers during playback

1. Select the desired track using SEARCH ◀◀ or ▶▶ until the display shows the required track number.
2. Store the desired track by pressing PROGRAM once.  
→ The display will show PROGRAM, the number of the stored track, Pr and the total number of stored tracks.
3. Select and store all desired tracks in this way.
4. To play your CD programme in the desired sequence, first press STOP ■ once and then press PLAY/PAUSE ▶▶ to start playback, otherwise:  
→ playback will start at the last programmed track, followed by CD tracks in normal sequence instead of your programmed sequence.

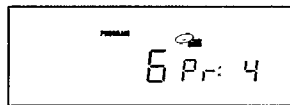

### Programming track numbers from STOP position

1. Select the desired track using SEARCH ◀◀ or ▶▶ until the display shows the required track number.
2. Store the desired track by pressing PROGRAM once.  
→ The display will show PROGRAM, the number of the stored track, Pr and the total number of stored tracks.
3. Select and store all desired tracks of a CD in this way.
4. To play your CD programme in the desired sequence, first press STOP ■ once and then press PLAY/PAUSE ▶▶ to start playback, otherwise:  
→ only the last programmed track will be played back.

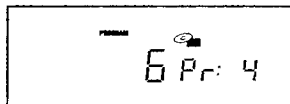

### Checking a programme

1. To review the set programme, press PROGRAM more than 2 seconds.  
→ The display will show the track numbers you have selected in sequence.  
→ The display will show *no prog* if no tracks have been stored.
2. Start playback of the programme by pressing PLAY • PAUSE ▶▶.

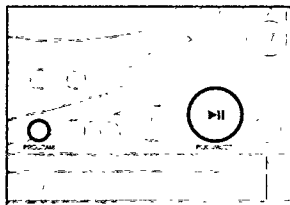

### Erasing a programme

You can erase a programme by:

- pressing STOP ■ twice;
- opening the CD tray;
- pressing the POWER button to the off position.

## CASSETTE PLAYBACK

1. Set the CD-TAPE-TUNER button to TAPE.
2. Press STOP•OPEN ■▲ to open the cassette holder.
3. Insert a recorded cassette.
4. Press PLAY ► and playback will start.
5. For brief interruptions, press PAUSE ■■. Press PAUSE ■■ again to resume playback.
6. By pressing ◀◀ or ▶▶, fast winding of the tape is possible in both directions.
7. To stop playback, press STOP•OPEN ■▲.
  - The keys are automatically released at the end of the tape, except if PAUSE ■■ has been activated.
8. To switch off the set, press the POWER button.

**Note:** While the PLAY ► or RECORD ● keys are pressed on the set, it will not be possible to change to another source.

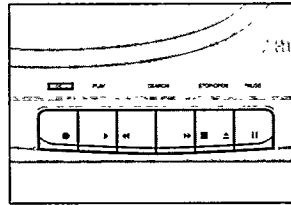

## CASSETTE RECORDING

### General information on cassette recording

- Recording is permissible insofar as copyright or other rights of third parties are not infringed.
- This deck is not suited for recording on CHROME (IEC II) or METAL (IEC IV) type cassettes. For recording you should use NORMAL type cassettes (IEC I) on which the tabs have not been broken.
- The recording level is set automatically. Altering the VOLUME, INCREDIBLE SURROUND or DSC controls will not affect the recording in progress.
- No recording will take place during the first 7 seconds, when the leader tape passes the recorder heads.
- To prevent the accidental erasure of a recording, keep the cassette side to be safeguarded in front of you and break out the left tab. Recording on this side is no longer possible. To render this safeguard ineffective, cover the tabs with a piece of adhesive tape.

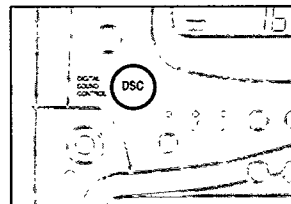
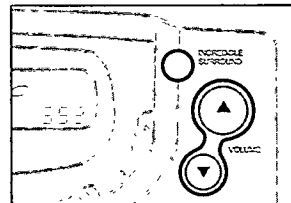

# CASSETTE RECORDER

English

## RECORDING FROM THE RADIO

1. Set the CD-TAPE-TUNER button to TUNER.
2. Tune to the desired radio station using the TUNING control (See **TUNING TO RADIO STATIONS**).  
→ When STEREO appears on the display, you are receiving a FM-stereo transmitter.
3. Press STOP•OPEN ■▲ to open the cassette holder.
4. Insert a suitable cassette.
5. Press RECORD ● to start recording.
6. For brief interruptions, press PAUSE ||. To resume recording, press PAUSE || again.
7. To stop, press STOP•OPEN ■▲.

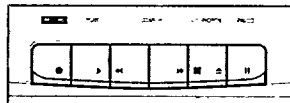

## CD SYNCRO - RECORDING FROM THE CD PLAYER

1. Set the CD-TAPE-TUNER button to CD.
2. Insert a CD and if desired, programme track numbers.
3. Press STOP•OPEN ■▲ to open the cassette holder.
4. Insert a suitable cassette.
5. Press RECORD ● to start recording.  
→ Playing of the CD programme starts automatically from the beginning of the programme. It is not necessary to start the CD player separately.
6. For brief interruptions, press PAUSE || deck key. To resume recording, press PAUSE || again.
7. To stop recording press STOP•OPEN ■▲.

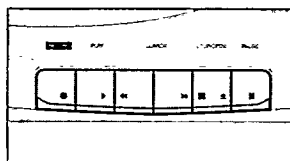

### To select and record a particular passage within a track

1. Press SEARCH ◀◀ or ▶▶ to select a passage.
2. Put the CD player in PAUSE || position at the selected passage.  
→ Recording will start from this exact point when you press RECORD ●.

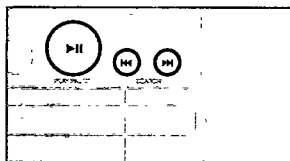

## PRECAUTIONS & GENERAL MAINTENANCE

- Place the set on a hard, flat surface so that it does not tilt.
- Do not expose the set, CDs, batteries or cassettes to humidity, rain, sand, direct sunlight or other places where high temperatures can occur, such as in the vicinity of heating apparatus or in motor cars parked in the sun.
- Do not cover the set. The amplifier produces heat which must dissipate freely, so make sure that there is sufficient ventilation around the set. A minimum gap of 15 cm is necessary.
- The mechanical parts of the CD player and the cassette deck contain self-lubricating bearings and must not be oiled or lubricated.
- A chamois leather slightly moistened with water is sufficient for cleaning the housing. Do not use cleaning agents containing alcohol, spirits, ammonia or abrasives as these may harm the housing.

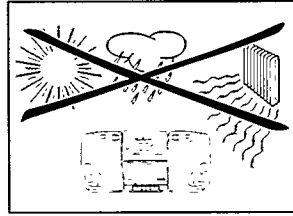

## CD MAINTENANCE

- The lens of the CD player should never be touched.
- The lens may cloud over if the CD player is moved from cold to warm surroundings. The CD player will not start. Give the player some time to acclimatise.
- To take a CD out of its box, press the centre spindle while lifting the CD. Always pick up the CD by the edge and replace the CD back in its box after use to avoid scratching and dust.
- To clean the CD, wipe in a straight line from the centre towards the edge using a soft, lint-free cloth. Do not use cleaning agents as they may damage the disc.
- Never write on a CD or attach stickers to it.

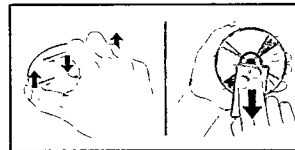

## RECORDER MAINTENANCE

To ensure a good recording and playback quality, clean the indicated parts (A), (B) and (C) after every 50 hours of operation or, on average, once a month. Use a cotton bud slightly moistened with alcohol or a special head cleaning fluid.

- Open the cassette door by pressing STOP•OPEN ■▲.
- Press PLAY ► and clean the rubber pressure rollers (C).
- Then press PAUSE II and clean the capstans (B) and the heads (A).
- After cleaning, press STOP•OPEN ■▲.

**Note:** Cleaning of the heads (A) can also be done by playing a cleaning cassette through once.

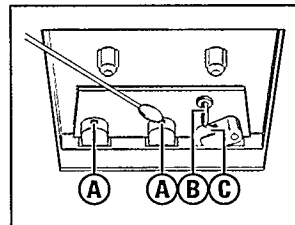

# TROUBLESHOOTING

English

If a fault occurs, first check the points listed below before taking the set for repair. If you are unable to remedy a problem by following these hints, consult your dealer or service centre.

**WARNING:** Under no circumstances should you try to repair the set yourself, as this would invalidate the guarantee.

## **PROBLEM**

– *POSSIBLE CAUSE*

- REMEDY

## **Set does not react to operation of any of the controls**

– *Electrostatic discharge.*

- Switch off the set, disconnect the mains plug, reconnect after a few seconds.
- *Batteries are exhausted.*
- Insert fresh batteries.

## **Display does not function properly**

– *Electrostatic discharge.*

- Switch off the set, disconnect the mains plug and reconnect after a few seconds.
- *Set runs on batteries.*
- Switch to mains supply.

## **No sound**

– *VOLUME is not adjusted.*

- Adjust the VOLUME.
- *Headphones are connected.*
- Disconnect headphones.
- *Batteries are exhausted.*
- Insert fresh batteries.
- *Batteries are incorrectly inserted.*
- Insert the batteries correctly.
- *Mains lead is not securely connected.*
- Connect the mains lead properly.
- *Batteries loaded but mains lead still plugged in and connected.*
- *Pull out the mains plug from the MAINS socket and the set.*
- *Speakers not connected.*
- *Connect speakers*

## **Bad sound**

– *Unsuitable speakers are used.*

- Use supplied speakers.
- *Batteries are exhausted.*
- Replace batteries.

## **Poor bass sound**

– *Speakers not in phase.*

- Connect speaker poles correctly, '+' pole (red marked wire) to '+'; '-' pole (black/unmarked wire) to '-'.

## **No sound on left or right side**

– *Speaker wrongly connected.*

- Connect speaker properly.
- *Speaker not connected.*
- *Connect speaker*

## **Reversed left and right sound**

– *Speakers are wrongly connected.*

- Connect speakers properly, L to left, R to right.

## **Severe radio hum or noise**

– *Set too close to TV, VCR or computer.*

- Increase the distance.

## **Poor radio reception**

– *Weak radio signal.*

- FM: aim and extend the telescopic aerial for best reception;
- AM: rotate the entire set.

## **Poor cassette sound quality**

– *Dust and dirt on the heads, capstan or pressure roller.*

- Clean the heads etc., see Maintenance.
- *Use of incompatible cassette types (METAL or CHROME).*
- Only use NORMAL (IEC I) for recording.



# TROUBLESHOOTING

## **Recording does not work**

- *Cassette tab(s) may be broken out.*
- Apply a piece of adhesive tape over the missing tab space.

## **CD playback does not work**

- *CD is badly scratched or dirty.*
- Replace or clean the CD, see Maintenance.
- *No CD inserted.*
- Insert CD.
- *CD inserted upside down.*
- Insert CD with printed side facing up.
- *Laser lens steamed up*
- Wait until lens has acclimatized

## **The CD skips tracks**

- *Laser lens is steamed up.*
- Wait until lens has acclimatized.
- *CD is damaged or dirty.*
- Replace or clean the CD.
- *PROGRAM/SHUFFLE is active.*
- Switch off the PROGRAM/SHUFFLE function.

## **Remote control does not function properly**

- *Batteries are exhausted.*
- Insert new batteries.
- *Batteries are incorrectly inserted.*
- Insert batteries correctly.
- *Distance or angle between the set is too large.*
- Reduce the distance or angle.

*The type plate is located on the base of the set.*

**GUARANTEE FOR AUSTRALIA**

The benefits given to the purchaser by this warranty are in addition to all other rights and remedies, which, under the Trade Practices Act or other Commonwealth or State law, the purchaser or owner has in respect of the product.

The Philips product carries the following warranties:

- C-series HiFi-systems 12 months.
- Compact Disc Players: 12 months.
- Home Audio Systems: 6 months.
- Clock radios, portable radios, cassette recorders, cassette players and radio recorders: 90 days.

Any defect in materials or workmanship occurring within the specified period from the date of delivery, will be rectified free of charge by the retailer from whom this product was purchased.

**Note:** Please retain your purchase docket to assist prompt service.

**Conditions of this warranty**

1. All claims for warranty service must be made to the retailer from whom this product was purchased. All transport charges incurred in connection with warranty service or replacement will be paid by the purchaser.
2. These warranties do not cover batteries and extend only to defects in materials or workmanship occurring under normal use of the product where operated in accordance with our instructions.

**Philips**  
**Consumer Products Division**  
**Technology Park**  
**Figtree Drive, Australia Centre**  
**Homebush 2140**  
**New South Wales**

**GUARANTEE FOR NEW ZEALAND**

Thank-you for purchasing this quality Philips product. Philips New Zealand Ltd guarantees this product against defective components and faulty workmanship for a period of 12 months. Any defect in materials or workmanship occurring within 12 months from the date of purchase subject to the following conditions will be rectified free of charge by the retailer from whom this product was purchased.

**Conditions**

1. The product must have been purchased in New Zealand. As proof of purchase, retain the original sales docket indicating the date of purchase.
2. The guarantee applies only to faults caused by defective components, or faulty workmanship on the part of the manufacturer.
3. The guarantee does not cover failures caused by misuse, neglect, normal wear and tear, accidental breakage, use on the incorrect voltage, use contrary to operating instructions, or unauthorised modification to the product or repair by an unauthorised technician.
4. Reasonable evidence (in the form of a sales docket) must be supplied to indicate that the product was purchased no more than 12 months prior to the date of your claim.
5. In the event of a failure, Philips shall be under no liability for any injury, or any loss or damage caused to property or products other than the product under guarantee.

This guarantee does not prejudice your rights under common law and statute, and is in addition to the normal responsibilities of the retailer and Philips.

**How to claim**

Should your Philips product fail within the guarantee period, please return it to the retailer from whom it was purchased. In most cases the retailer will be able to satisfactorily repair or replace the product. However, should the retailer not be able to conclude the matter satisfactorily, or if you have other difficulties claiming under this guarantee, please contact.

**The Guarantee Controller**  
**Philips New Zealand Ltd.**

✉ P.O. Box 41.021

**Auckland**

☎ (09) 84 94 160  
fax ☎ (09) 84 97 858

### GARANTÍA PARA MÉXICO

Este aparato está fabricado con materiales de alta calidad y ha sido cuidadosamente verificado. Philips, por lo tanto, da a usted una garantía de 12 meses a partir de su fecha de compra.

La garantía ampara la reposición de las piezas defectuosas debidas a fallas en su montaje o en los materiales, incluyendo la mano de obra necesaria para su reemplazo en nuestras Sucursales o talleres autorizados.

En caso de fallas en su aparato le rogamos se sirva poner en contacto con su distribuidor.

Esta garantía no cubrirá las averías que resulten como consecuencia de una instalación incorrecta del aparato, manifiesto maltrato o uso inadecuado del mismo.

Philips se obliga a reparar y devolver a usted su aparato en un plazo no mayor de 30 días hábiles contados a partir de la fecha de haber ingresado su aparato a uno de nuestros talleres.

Para que esta garantía sea válida, es necesario que el certificado que figura en la parte posterior de esté instructivo haya sido debidamente llenado en el momento de la compra del aparato.

En caso de extravío del certificado con la presentación de la factura o remisión de su aparato podrá hacer efectiva la garantía correspondiente.

Si usted tiene alguna duda o pregunta que no le pueda solucionar su distribuidor, por favor ponerse en contacto con:

**Centro de Servicio Philips**  
**Blvd. de los Ferrocarriles No.339**  
**Col. Industrial Vallejo, 02300**  
**México, D.F.**

☎ 728-42 00

**Centro de Información al Consumidor**

☎ 368-77 88 ó 91 (800) 504-62 00

### CERTIFICADO DE GARANTIA INTERNACIONAL

Este aparelho é garantido pela Philips da Amazônia Indústria Eletrônica LTDA, por um período superior ao estabelecido por lei. Porém, para que a garantia tenha validade, é imprescindível que, além deste certificado, seja apresentada a nota fiscal de compra do produto.

1. Philips da Amazônia Indústria Eletrônica LTDA assegura ao proprietário consumidor deste aparelho a garantia de 365 dias (90 dias legal e 275 dias adicional) contados a partir da data de entrega do produto, conforme expresso na nota fiscal de compra, que passa a fazer parte deste certificado.
2. Esta garantia perderá sua validade se:
  - a. O defeito apresentado for ocasionado por uso indevido ou em desacordo com o seu manual de instruções.
  - b. O produto for alterado, violado ou consertado por pessoa não autorizada pela Philips.
  - c. O produto for ligado a fonte de energia (rede elétrica, pilhas, bateria, etc.) de características diferentes das recomendadas no manual de instruções e/ou no produto.
  - d. O número de série que identifica o produto estiver de alguma forma adulterado ou rasurado.
3. Estão excluídos desta garantia defeitos decorrentes do descumprimento do manual de instruções do produto, de casos fortuitos ou de força maior, bem como aqueles causados por agentes da natureza e acidentes.
4. Excluem-se igualmente desta garantia defeitos decorrentes do uso dos produtos, em serviços não doméstico/residencial regular ou em desacordo com o uso recomendado.
5. Nos municípios onde não exista oficina autorizada de serviço Philips, as despesas de transporte do aparelho e/ou técnico autorizado, correm por conta do sr. consumidor requerente do serviço.

6. Este produto tem garantia internacional. O serviço técnico (durante ou após a garantia) é disponível em todos os países onde este produto é oficialmente distribuído pela Philips. Nos países onde a Philips não distribui este produto, o serviço técnico da Philips local poderá prestar tal serviço, contudo poderá ocorrer algum atraso no prazo de atendimento se a devida peça de reposição e o manual técnico não forem prontamente disponíveis.
7. A garantia não será válida se o produto necessitar de modificações ou adaptações para habilitá-lo a operar em qualquer outro país que não aquele para o qual foi designado, fabricado, aprovado e/ou autorizado, ou ter sofrido qualquer dano decorrente deste tipo de modificação.

Philips da Amazônia Indústria Eletrônica LTDA.  
Dentro do Brasil, para informações adicionais sobre o produto ou para eventual necessidade de utilização da rede de oficinas autorizadas, ligue para o centro de informações ao consumidor, tel 0800-123123 (discagem direta gratuita) ou escreva para a:

**caixa postal 21462 - CEP 04698-970  
São Paulo - Sp.**

Horário de atendimento: de segunda à sexta-feira, das 08:00 às 19:00 h; aos sábados das 08:00 às 13:00 h.

Para atendimento fora do Brasil contate a Philips local ou a: **Philips Consumer Service**  
**Beukenlaan 25651 CD Eindhoven,**  
**The Netherlands**



---

---

---

---

---

---





---

---

---

---

# AZ 2415 Portable CD Micro System

Meet Philips at the Internet  
<http://www.philips.com>

**CLASS 1  
LASER PRODUCT**

