

CD Radio Cassette Recorder

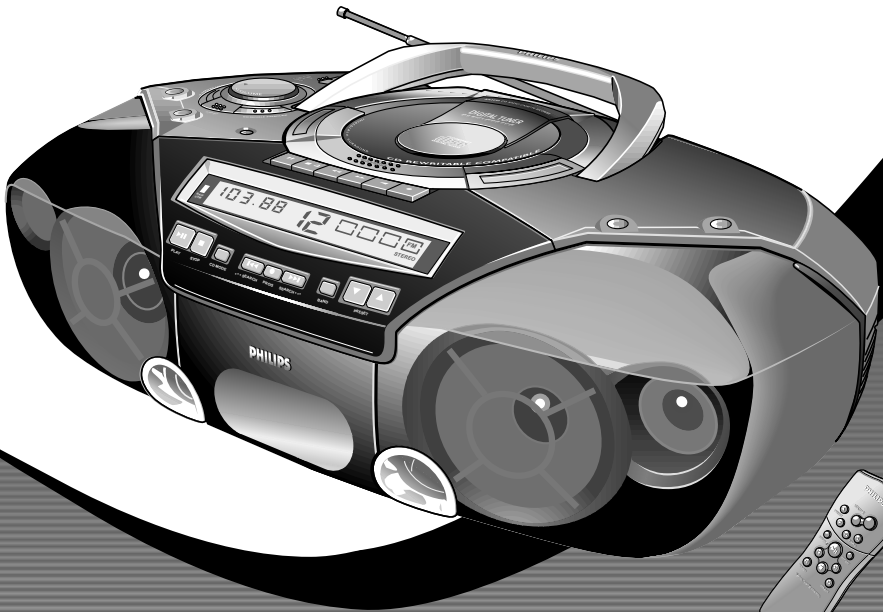

AZ-2030

AZ-2035



Toll Free Help Line

Ligne d'assistance en service libre

Línea de ayuda telefónica sin cargo

800-531-0039



Let's make things better.



PHILIPS

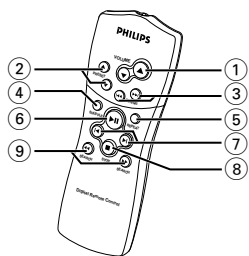
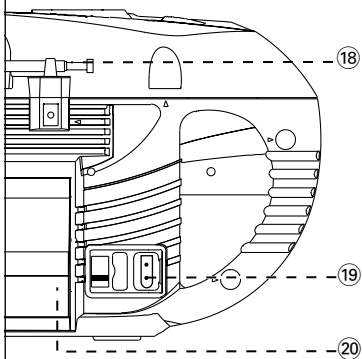
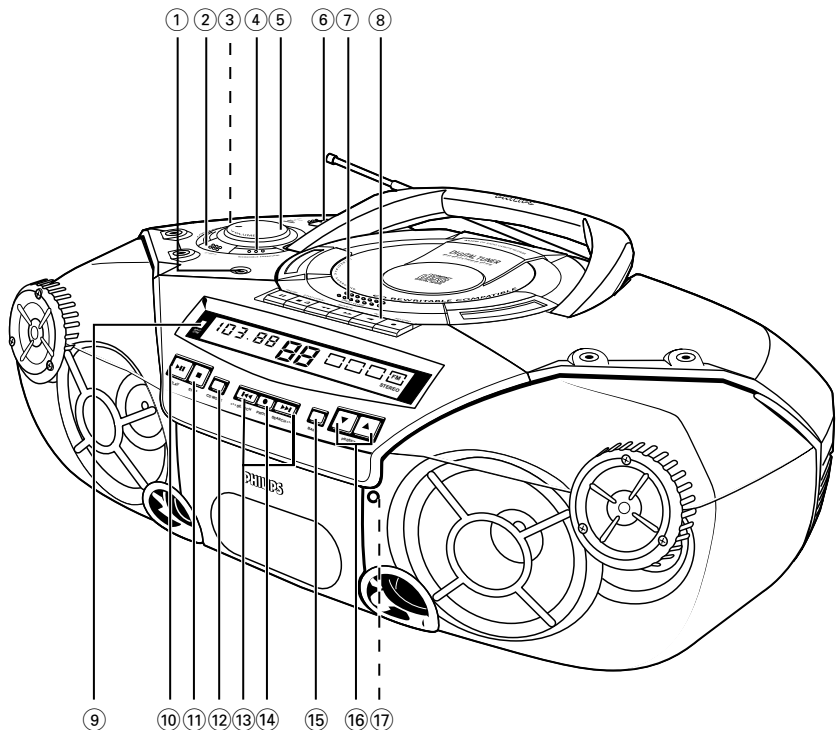

CONTROLS

TOP AND FRONT PANELS

- ① - 3.5 mm stereo headphone jack

Note: Connecting headphones will switch off the speakers.

- ② **ULTRABASS** - selects a more vivid bass response
- ③ **ULTRA HIGH CLARITY** - adjusts the treble tones
- ④ **INCREDIBLE SURROUND** - creates a super-enhanced stereo effect
- ⑤ **VOLUME** - to adjust volume level
- ⑥ **POWER slider** - selects the sound source for CD/ TUNER / TAPE and also the POWER OFF switch
- ⑦ **OPEN•CLOSE** - opens/ closes the CD door
- ⑧ **CASSETTE RECORDER keys**
RECORD ● - starts recording
PLAY ◀ - starts playback
SEARCH ◀▶ - fast winds/rewinds the tape
STOP•OPEN ■▲ - stops the tape;
- opens the cassette door
- PAUSE II** - pauses recording or playback
- ⑨ **BATT LOW** - indicates when battery power is running low
- ⑩ **PLAY ▶II** - starts or pauses CD playback
- ⑪ **STOP ■** - stops CD playback;
erases a CD program
- ⑫ **CD MODE** - selects different play modes:
REPEAT or SHUFFLE (random) order
- ⑬ **SEARCH ◀▶**
Tuner: - (down, up) tunes to radio stations;
CD: - searches back and forward within a track;
- skips to the beginning of a current track/ previous/ later track

- ⑭ **PROG** -
CD: programs tracks and reviews the program;
Tuner: programs preset radio stations
- ⑮ **BAND** - selects waveband
- ⑯ **PRESET ▼, ▲** - selects a preset tuner station (down, up)
- ⑰ **REMOTE SENSOR** - for AZ2035 model only:
infrared sensor for remote control

BACK PANEL

- ⑱ **Telescopic antenna** - improves FM reception
- ⑲ **AC MAINS** - inlet for power cord
- ⑳ **Battery compartment** - for eight batteries, type R-20, UM-1 or D-cells

REMOTE CONTROL (for AZ2035 only)

- ① **VOLUME ▲, ▼** - adjusts volume level
- ② **PRESET ▲, ▼** (up, down) - selects a preset radio station
- ③ **TUNING ◀▶** (down, up) - tunes to radio stations
- ④ **SHUFFLE** - to play CD tracks in random order
- ⑤ **REPEAT** - repeats a track/ CD program/ entire CD
- ⑥ **▶II** - starts and pauses CD playback/ interrupts CD playback
- ⑦ **◀, ▶** - skips to the beginning of a current track/ previous/ later track
- ⑧ **STOP ■** - stops CD playback or erases a CD program
- ⑨ **SEARCH ◀, ▶** - searches backwards or forwards within a track/CD

Whenever convenient, use the power supply if you want to conserve battery life. Make sure you remove the power plug from the set and wall outlet before inserting batteries.

BATTERIES (not included)

1. Open the battery compartment and insert 8 batteries, type **R-20**, **UM-1** or **D-cells**, (preferably alkaline) with the correct polarity as indicated by the "+" and "-" symbols inside the compartment.

Remote control (for AZ2035 model only)

Open the battery compartment and insert two batteries, type **AAA**, **R03** or **UM4** (preferably alkaline).

2. Replace the compartment door, making sure the batteries are firmly and correctly in place. The set is now ready to operate.
 - If **BATT LOW** lights up, battery power is running low.
 - The **BATT LOW** indicator eventually goes out if the batteries are too weak.

Incorrect use of batteries can cause electrolyte leakage and will corrode the compartment or cause the batteries to burst.

Therefore:

- Do not mix battery types: e.g. alkaline with carbon zinc. Only use batteries of the same type for the set.
- When inserting new batteries, do not try to mix old batteries with the new ones.
- Remove the batteries if the set is not to be used for a long time.
- **Batteries contain chemical substances, so they should be disposed of properly.**

Using AC POWER

1. Check if the power supply, **as shown on the type plate located on the bottom of the set**, corresponds to your local power supply. If it does not, consult your dealer or service center.
2. If your set is equipped with a voltage selector, adjust the selector so that it matches with the local power.
3. Connect the power cord to the wall outlet and the set is now ready for use.
4. To disconnect the set from the power supply completely, remove the power plug from the wall outlet.

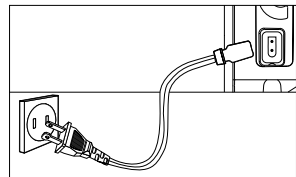
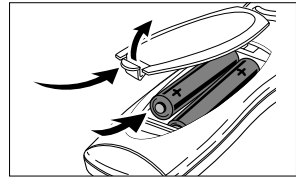
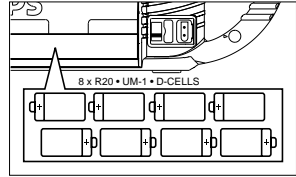

BASIC FUNCTIONS

Switching on and off

- Adjust the **POWER** slider to the desired sound source: **CD, TUNER** or **TAPE**.
- During playback, the **PLAY ►II**, **STOP ■** and **PRESET ▼, ▲** buttons on the set light up
- The set is switched off when the **POWER** slider is in the **TAPE/OFF** position and the keys on the tape deck are released.
- The volume, tone, sound settings and tuner presets will be retained in the set's memory.

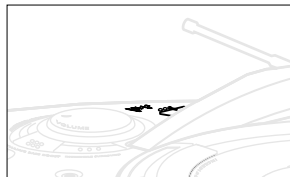

PHILIPS demo mode

1. On the set, press the **CD STOP ■** button for 5 seconds.
→ **PH..IL ..IPS** scrolls across the display continuously in the demo mode.
2. To return to the current display you can either:
 - press any function button on the front panel. This interrupts the demo mode for 30 seconds;
 - press the **CD STOP ■** button for 5 seconds. **PH..IL ..IPS** scrolls across the display once before the demo mode is cancelled.

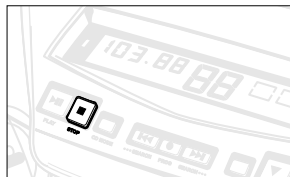

Adjusting volume and sound

1. Turn the **VOLUME** control clockwise to increase or anti-clockwise to decrease volume on the set (*for AZ2035 model only*; or press **VOLUME ▲** or **▼** on the remote control).
→ Display shows the volume level **VOL** and a number from 0-32.
2. Press **ULTRABASS** once or more to switch on or off.
→ If on, indicator **1** lights up. Press again if you want extra bass and indicator **2** lights up.
3. To adjust the treble tone level, press **ULTRA HIGH CLARITY** once or more to switch on or off.
→ If on, the indicator lights up.
4. Press **INCREDIBLE SURROUND** once or more to switch the surround sound effect on or off.
→ If on, the indicator lights up.

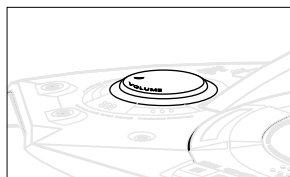
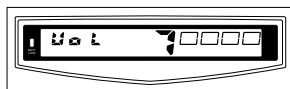
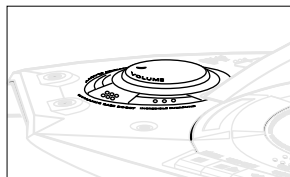

Note: The effect of **INCREDIBLE SURROUND** may vary with different types of music.

GENERAL INFORMATION

General maintenance

- Do not expose the set, batteries, CDs or cassettes to humidity, rain, sand or excessive heat caused by heating equipment or direct sunlight.
- To clean the set, use a soft, slightly dampened chamois leather. Do not use any cleaning agents containing alcohol, ammonia, benzene or abrasives as these may harm the housing.



Safety information

- Place the set on a hard and flat surface so that the system does not tilt. Make sure there is adequate ventilation to prevent the system from overheating.
- The mechanical parts of the set contain self-lubricating bearings and must not be oiled or lubricated.

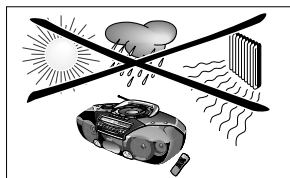





TUNING TO RADIO STATIONS

1. Select **TUNER** source.

→  is displayed briefly and then the radio station frequency, waveband and, if programmed, a preset number is shown.

2. Press **BAND** once or more to select your waveband.

3. Press **SEARCH**  or  (for AZ2035 model only: or on the remote control **TUNING**  or ) and release when the frequency in the display starts running.

→ The tuner automatically tunes to a station of sufficient reception. Display shows  during automatic tuning.

→ If an FM station is received in stereo, **STEREO** is shown.

4. Repeat **step 3** if necessary until you find the desired station.

- To tune to a weak station, press **SEARCH**  or  briefly and repeatedly until you have found optimal reception.



To improve radio reception

- For **FM**, pull out the telescopic antenna. Incline and turn the antenna. Reduce its length if the signal is too strong (very close to a transmitter).
- For **AM**, the set is provided with a built-in antenna so the telescopic antenna is not needed. Direct the antenna by turning the whole set.

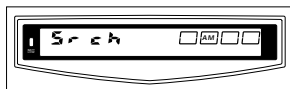

Programming radio stations

You can store up to a total of 30 radio stations in the memory.

1. Tune to your desired station (see **Tuning to radio stations**).
2. Press **PROG** to activate programming.
 - Display: **PROGRAM** flashes.
3. Press **PRESET** ▼ or ▲ once or more to allocate a number from 1 to 30 to this station.
4. Press **PROG** again to confirm the setting.
 - Display: **PROGRAM** disappears, the preset number and the frequency of the preset station are shown.
5. Repeat the above four steps to store other stations.
 - You can erase a preset station by storing another frequency in its place.

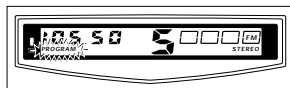
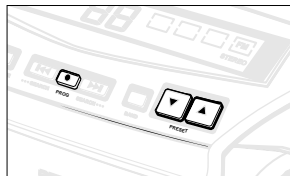
**Tuning to preset stations**

Press **PRESET** ▼ or ▲ until the desired preset station is displayed.

PLAYING A CD

This CD player plays Audio Discs including CD-Recordables and CD-Rewritables.

1. Select **CD** source.

→ and are displayed briefly, if no CD is inserted.

2. Press **OPEN•CLOSE** to open the CD compartment.

→ Display: when you open the CD compartment.

3. Insert a CD with the printed side facing up and press **OPEN•CLOSE** to close the CD compartment.

→ Display: the CD player scans the contents of a CD, and then the total number of tracks and playing time are shown.

Display: is shown if you have inserted a non-finalized CD-R(W).

4. Press **PLAY** ▶|| (for AZ2035 model only: or on the remote control ▶||) to start playback.

→ Display: Current track number and elapsed playing time of the track during CD playback.

5. To pause playback press **PLAY** ▶||.

Press **PLAY** ▶|| again to resume play.

→ Display: the elapsed playing time flashes when playback is on pause.

6. To stop CD playback, press **STOP** ■.

Note: CD play will also stop when:

- the CD door is opened;
- the CD has reached the end;
- you select another source: **TAPE** or **TUNER**.

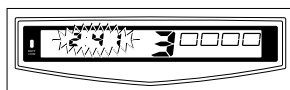
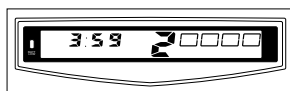
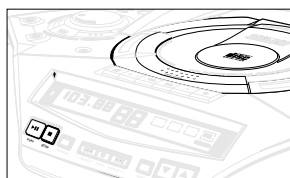
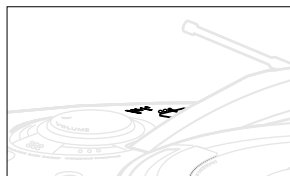

Selecting a different track

- Press **SEARCH** ◀◀ or ▶▶ on the set, (for AZ2035 model only: or on the remote control ◀◀ or ▶▶) once or repeatedly until the desired track number appears in the display.
- If you have selected a track number shortly after loading a CD or in the PAUSE position, you will need to press **PLAY** ▶▶ (for AZ2035 model only: or on the remote control ▶▶) to start playback.

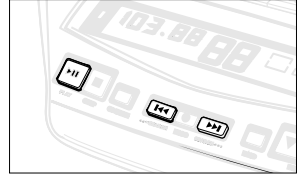

Finding a passage within a track

1. Press and hold down **SEARCH** ◀◀ or ▶▶ (for AZ2035 model only: or on the remote control ◀◀ or ▶▶).
→ The CD is played at high speed and low volume.
2. When you recognize the passage you want, release **SEARCH** ◀◀ or ▶▶.
– Normal playback continues.

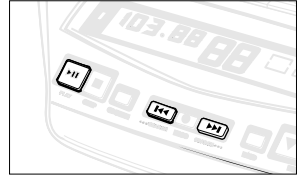

Note: During a CD program or if SHUFFLE/ REPEAT is active, searching is only possible within a track.

Different play modes: SHUFFLE and REPEAT

You can select and change the various play modes before or during playback. The play modes can also be combined with **PROG.**

SHUFFLE - tracks of the entire CD/ program are played in random order

SHUFFLE and **REPEAT ALL** - to repeat the entire CD/ program continuously in random order

REPEAT ALL - to repeat the entire CD/ program

REPEAT - to play the current track continuously

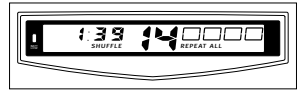

1. To select your play mode, press **CD MODE** (for AZ2035 model only: or on the remote control **SHUFFLE** or **REPEAT**) before or during playback until the display shows the desired function.
2. Press **PLAY** ▶▶ to start playback if in the STOP position.
3. To return to normal playback, press **CD MODE** (for AZ2035 model only: or on the remote control the respective **SHUFFLE** or **REPEAT** button) until the various SHUFFLE/ REPEAT modes are no longer displayed.
– You can also press **STOP** ■ to cancel your play mode.

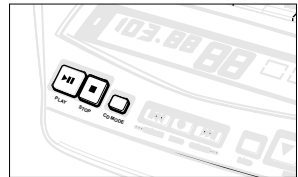

Note: In SHUFFLE mode, the display shows rapid patterns e.g. ◀◀, ▶▶ when the CD player selects a random track number.

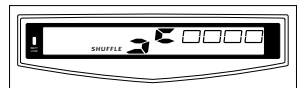

CD player and CD handling

- If the CD player cannot read CDs correctly, use a commonly available cleaning CD to clean the lens before taking the set to repair. Other cleaning methods may destroy the lens.
- The lens of the CD player should never be touched!
- Sudden changes in the surrounding temperature can cause condensation to cloud over on the lens of your CD player. Playing a CD is then not possible. Do not attempt to clean the lens but leave the set in a warm environment until the moisture evaporates.
- Always keep the CD compartment closed to avoid dust on the lens.
- To take a CD out of its box, press the center spindle while lifting the CD. Always pick up the CD by the edge and return the CD to its box after use to avoid scratching and dust.
- To clean the CD, wipe in a straight line from the center towards the edge using a soft, lint-free cloth. Do not use cleaning agents as they may damage the disc.
- Never write on a CD or attach any stickers to it.

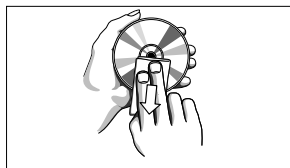
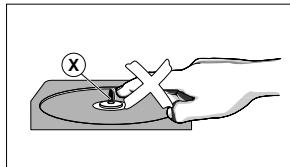

CASSETTE PLAYBACK

1. Select **TAPE** source.
→ The display shows **ERR** throughout tape operation.
2. Press **STOP•OPEN** **■▲** to open the cassette door.
3. Insert a recorded cassette and close the cassette door.
4. Press **PLAY** **◀** to start playback.
5. To interrupt playback, press **PAUSE** **||**. To resume, press this key again.
6. By pressing **SEARCH** **◀◀** or **▶▶** on the set, fast winding of the tape is possible in both directions.
7. To stop the tape, press **STOP•OPEN** **■▲**.
– The keys are automatically released at the end of the tape, except if **PAUSE** **||** has been activated.

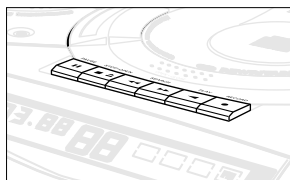
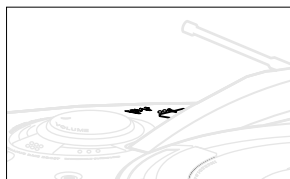

RECORDING

GENERAL INFORMATION ON RECORDING

- Recording is permissible insofar as copyright or other rights of third parties are not infringed.
- This deck is not suitable for recording on CHROME (IEC II) or METAL (IEC IV) type cassettes. For recording, use NORMAL type cassettes (IEC I) on which the tabs have not yet been broken.
- *The best recording level is set automatically.* Altering the **VOLUME, INCREDIBLE SURROUND, ULTRABASS** or **ULTRA HIGH CLARITY** controls will not affect the recording in progress.
- At the very beginning and end of the tape, no recording will take place during the 7 seconds when the leader tape passes the recorder heads.
- To protect a tape from accidental erasure, have the tape in front of you and break out the left tab. Recording on this side is no longer possible. If, however, you wish to record over this side again, cover the tabs with a piece of adhesive tape.

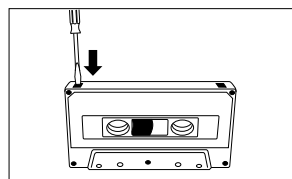

SYNCHRO START CD RECORDING

1. Select **CD** source.
2. Insert a CD and if desired, program track numbers.
3. Press **STOP•OPEN** **■▲** to open the cassette door.
4. Insert a suitable cassette into the cassette deck and close the cassette door.
5. Press **RECORD** **●** to start recording.
 - Playing of the CD program starts automatically from the beginning of the program. *It is not necessary to start the CD player separately.*

To select and record a particular passage within a track

- Press and hold down **SEARCH** **◀◀** or **▶▶** (for AZ2035 model only: or on the remote control **◀◀** or **▶▶**).
- When you recognize the passage you want, release **SEARCH** **◀◀** or **▶▶**.
- To pause CD playback press **PLAY** **▶▶** (for AZ2035 model only: or on the remote control **▶▶**).
- Recording will begin from this exact point in the track when you press **RECORD** **●**.

6. For brief interruptions press **PAUSE** **||**. To resume recording, press **PAUSE** **||** again.
7. To stop recording, press **STOP•OPEN** **■▲**.

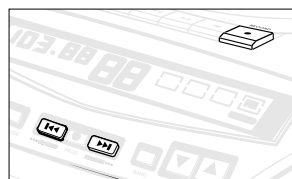
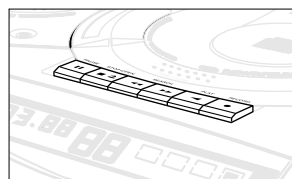
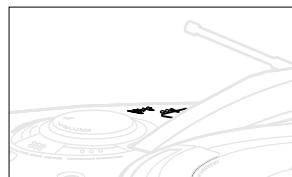

Recording from the radio

1. Tune to the desired radio station (See **Tuning to radio stations**).
2. Press **STOP•OPEN** ■▲ to open the cassette door.
3. Insert a suitable cassette into the cassette deck and close the cassette door.
4. Press **RECORD** ● to start recording.
5. For brief interruptions, press **PAUSE** II. To resume recording, press **PAUSE** II again.
6. To stop recording, press **STOP•OPEN** ■▲.

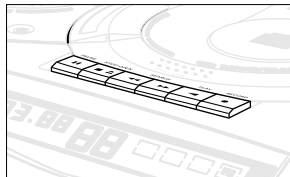

MAINTENANCE

Tape deck maintenance

To ensure quality recording and playback of the tape deck, clean parts (A), (B) and (C) shown in the diagram below, after approx. 50 hours of operation, or on average once a month. Use a cotton bud slightly moistened with alcohol or a special head cleaning fluid to clean the deck.

1. Open the cassette door by pressing **STOP•OPEN** ■▲.
2. Press **PLAY** ◀ and clean the rubber pressure roller (C).
3. Press **PAUSE** II and clean the magnetic heads (A) and also the capstan (B).
4. After cleaning, press **STOP•OPEN** ■▲.

Note: *Cleaning of the heads can also be done by playing a cleaning cassette through once.*

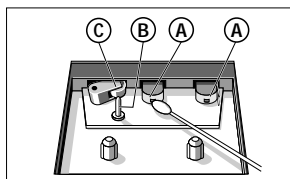

Environmental information

All unnecessary packaging material has been omitted. We have tried to make the packaging easy to separate into three mono-materials: cardboard (box), expandable polystyrene (buffer), polyethylene (bags, protective foam).

Your set consists of materials which can be recycled if disassembled by a specialized company. Please observe the local regulations regarding the disposal of packing materials, dead batteries and old equipment.

TROUBLESHOOTING

If a fault occurs, first check the points listed below before taking the set for repair.
If you are unable to remedy a problem by following these hints, consult your dealer or service center.

WARNING: *Do not open the set as there is a risk of electric shock. Under no circumstances should you try to repair the set yourself, as this would invalidate the warranty.*

PROBLEM

- POSSIBLE CAUSE
- REMEDY

No sound/power

- VOLUME not adjusted
- Adjust the VOLUME
- Headphones connected
- Disconnect headphones
- Power cord not securely connected
- Connect the AC power cord properly
- Batteries dead/ incorrectly inserted
- Insert (fresh) batteries correctly

Severe radio hum or noise

- Electrical interference: set too close to TV, VCR or computer
- Increase the distance

Poor radio reception

- Weak radio signal
- FM: Direct the FM telescopic antenna for optimum reception



indication

- No CD inserted
- Insert a CD
- CD badly scratched or dirty
- Replace/ clean CD, see MAINTENANCE
- Laser lens steamed up
- Wait until lens has cleared

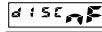

indication

- CD-R(W) is blank or the disc is not finalized
- Use a finalized CD-R(W)
- CD badly scratched or dirty
- Replace/ clean CD, see MAINTENANCE

The CD skips tracks

- CD is damaged or dirty
- Replace or clean the CD
- SHUFFLE or PROGRAM is active
- Switch off SHUFFLE/ PROGRAM

Poor cassette sound quality

- Dust and dirt on the heads, etc.
- Clean deck parts etc., see MAINTENANCE
- Use of incompatible cassette types (METAL or CHROME).
- Only use NORMAL (IEC I) for recording.

Recording does not work

- Cassette tab(s) may be broken
- Apply a piece of adhesive tape over the missing tab space.

Remote control does not function properly

- Batteries dead/ incorrectly inserted
- Insert (fresh) batteries correctly
- Distance/ angle between the set too large
- Reduce the distance/ angle
- Remote sensor obstructed by object, sticker etc.
- Remove obstruction/ make sure right hand side of cassette door is free from obstruction

The type plate is located on the bottom of the set.