

# PHILIPS

AZ 2000 Portable CD Radio Recorder

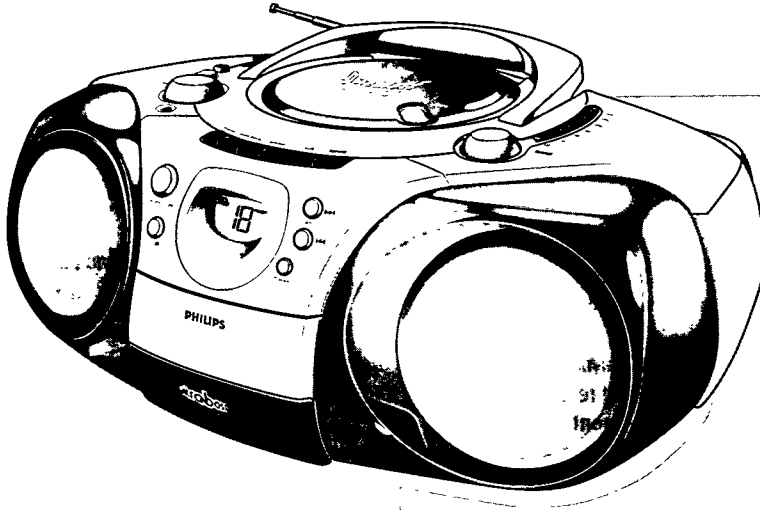

Instructions for use  
Mode d'emploi  
Instrucciones de manejo  
Manual de instruções  
使用説明書



# PHILIPS

**(AUS) Australia**

Guarantee .....Page 44

**English ..... 4**

English

**(BR) Brasil**

Garantía .....Página 45

**Français ..... 12**

Français

**(MEX) México**

**KOM**

Garantía .....Página 46

**Español ..... 20**

Español

**(NZ) New Zealand**

Guarantee .....Page 48

**Português ..... 28**

Português

**中文 ..... 36**

中文

**México**

Es necesario que lea cuidadosamente su instructivo de manejo.

	<b>PRECAUCIÓN - ADVERTENCIA</b>	
	No abrir, riesgo de choque eléctrico	
	<b>ATENCIÓN</b>	
	Verifique que el voltaje de alimentación sea el requerido para su aparato	
Para evitar el riesgo de choque eléctrico, no quite la tapa. En caso de requerir servicio, diríjase al personal calificado.		

Descripción:

**Tocadiscos de CD portátil**

Modelo:

**AZ 2000/01**

Alimentación:

**110-127/220-240 V; ~50-60 Hz**

Consumo:

**22 W**

Importador:

**Philips Mexicana, S.A. de C.V.**

Domicilio:

**Norte 45, # 669, Col. Industrial Vallejo**

Localidad y Telefono:

**C.P. 02300 México D.F., Tel. 7284200**

Exportador:

**Philips HK, Ltd.**

País de Origen:

**China**

Nº de Serie: \_\_\_\_\_

**LEA CUIDADOSAMENTE ESTE INSTRUCTIVO ANTES DE USAR SU APARATO.**

1

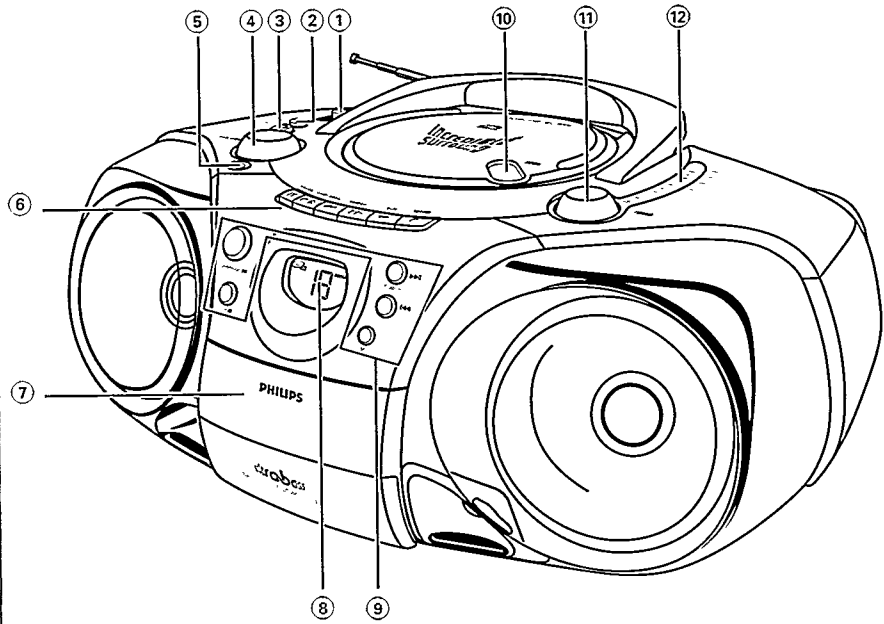

2

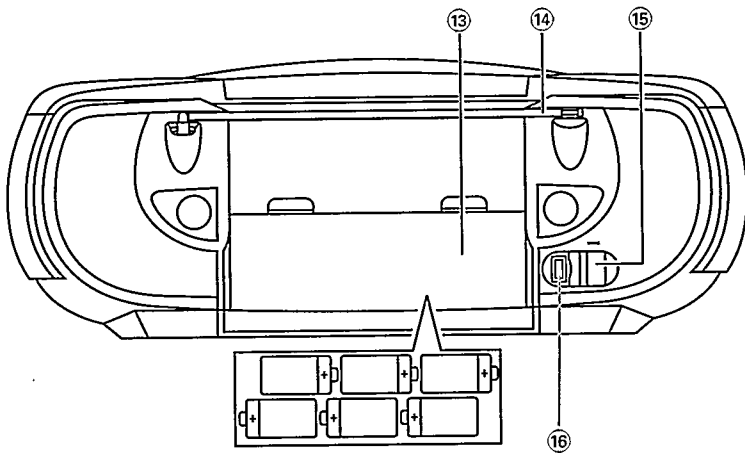

## TOP AND FRONT PANEL

- ① **Source selector:**  
**BAND (MW/FM), CD, TAPE/OFF-** to select source of sound/radio waveband, and also the power **OFF** switch
  - ② **INCREDIBLE SURROUND** - To create a phenomenal surround sound stereo effect
  - ③ **Bass control** - To select a more vivid bass response: **ULTRA BASS, DYNAMIC BASS BOOST, OFF**
  - ④ **VOLUME** - To adjust volume level
  - ⑤  3.5 mm stereo headphone socket
- Note:** – Connecting headphones will switch off the speakers

### **CASSETTE RECORDER:**

- ⑥ **PAUSE II** - To interrupt recording or playback.  
**STOP•OPEN ■ ▲** - To stop the tape and to open the cassette holder  
**SEARCH ◀◀ or ▶▶** - To fast wind/rewind the tape.  
**PLAY ◀** - To start playback.  
**RECORD ●** - To start recording.
- ⑦ **Cassette compartment**

## Batteries

Whenever convenient, use the mains supply if you want to conserve battery life. The battery supply will be switched off when the set is connected to the mains.

### **Batteries (optional)**

1. Open the battery compartment and insert six batteries, type R20, UM1 or D-cells (preferably alkaline) with the correct polarity as indicated by the (+) and (-) symbols inside the compartment.
  2. Replace the compartment door, making sure the batteries are firmly and correctly in place. The set is now ready to operate.
  3. Remove the batteries if the set is not to be used for a long time.
- Incorrect use of batteries can cause electrolyte leakage and will corrode the compartment or cause the batteries to burst. Therefore:
- Do not mix battery types, e.g. alkaline with carbon zinc. Only use batteries of the same type for the set.
  - When inserting new batteries, do not try to mix old batteries with the new ones.

**Batteries contain chemical substances, so they should be disposed of properly**

### **CD PLAYER**

- ⑧ **CD Display** - To show the CD functions
- ⑨ **PLAY/PAUSE ►II** - To start or interrupt CD play  
**STOP ■** - To stop playback or erase a programme  
**CD MODE** - To select a different play mode e.g. SHUFFLE/REPEAT; to programme and review programmed track numbers  
**SEARCH ◀◀ or ▶▶** - To skip or search a passage/ track backwards or forward
- ⑩ **OPEN** - To open/ close the CD door

### **RADIO**

- ⑪ - **TUNING** - To tune to radio stations.
- ⑫ - **Tuning dial pointer**

## BACK PANEL

- ⑬ **Battery door** - To open the battery compartment
- ⑭ **Telescopic aerial** - To improve FM reception.
- ⑮ **AC MAINS** - Socket for mains lead.
- ⑯ **Voltage Selector**

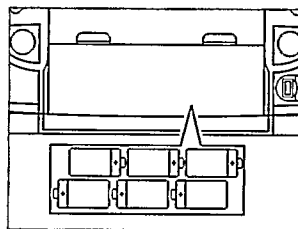

## AC MAINS

1. Check if the mains voltage as shown on the type plate on the base of the set, corresponds to your local mains voltage. If it does not, consult your dealer or service organisation.
2. If your set is equipped with a voltage selector, adjust it so that it matches with the local mains.
3. Connect the mains lead to the MAINS socket and the wall socket.  
→ The mains supply is now connected and ready for use.
4. To switch off completely, withdraw the mains lead from the wall socket.
  - Disconnect the mains lead from the wall socket to protect your set during heavy thunderstorms.
  - To avoid overheating of the set a safety circuit has been built in. Therefore your set may disconnect under extreme conditions. If this happens, switch the set off and let it cool down before reusing it.

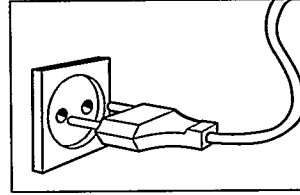

## Environmental information

All unnecessary packaging material has been omitted. We have done our utmost to make the packaging easily separable into three mono materials: cardboard, polystyrene and plastic.

**Your set consists of materials which can be recycled if disassembled by a specialized company. Please observe the local regulations regarding the disposal of packaging materials, exhausted batteries and old equipment.**

## RADIO RECEPTION

1. To select the desired station waveband, set the source selector to **(MW/FM)**.
2. Tune to a radio station using the tuning knob.
  - For **FM**, pull out the telescopic aerial.
  - Incline and turn the aerial. Reduce its length if the signal is too strong (very close to a transmitter).
  - For **MW, (AM)** the set is provided with a built-in aerial so the telescopic aerial is not needed. Direct the aerial by turning the whole set.
3. Adjust the sound using the **VOLUME, INCREDIBLE SURROUND** and **BASS** controls.
4. To switch off the radio, adjust the source selector to the **TAPE/OFF** position (with the cassette keys released)

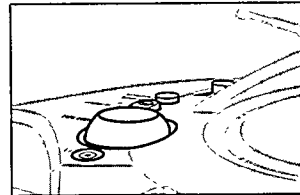

# CD PLAYER

English

## CD DISPLAY INDICATION

- **Total track number:** in stop mode
- **Current track number:** during CD play.
- **SHUFFLE/REPEAT modes:** when the respective mode is activated
- **PROGRAM:** When active, **P** also appears briefly when you store a track
- **NO:** no disc
- **E:** error in CD operation or with the CD (see Troubleshooting)
- **F:** program memory full

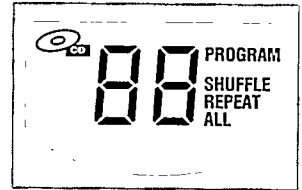

## PLAYING A CD

1. Set the source selector to **CD**
2. To open the CD door, press **OPEN** on the CD door.
3. Insert a CD with the printed side facing up and press the CD door gently to close.  
→ The CD player scans the contents of the CD and the total number of tracks is displayed.
4. Press **PLAY/PAUSE ►II** to start playback.
5. Adjust the sound using the **VOLUME, INCREDIBLE SURROUND** and **BASS** controls.
6. To interrupt playback press **PLAY/PAUSE ►II**. To resume, press **PLAY ►** again  
→ The current track number flashes in the display
7. To stop CD play, press **STOP ■**.
8. To switch off the set, adjust the source selector to **TAPE/OFF** position (with the cassette keys released)

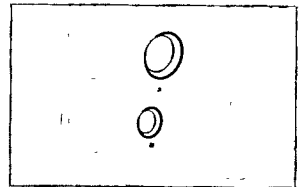
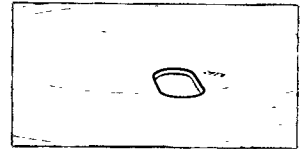

**Note:** CD playback will also stop when:

- the CD door is opened;
- the source selector is in **MW/FM** or **TAPE/OFF** position;
- the CD has reached to the end;

## SELECTING A DIFFERENT TRACK

During playback, you can use the **SEARCH** keys to select a particular track.

1. Press **SEARCH ►►** once for the next track, or press repeatedly until the desired track number appears in the display.  
Press **SEARCH ◀◀** once to return to the beginning of a current track.  
Press **SEARCH ◀◀** more than once for a previous track.
2. If you have selected a track number in the stop or pause position, you will need to press **PLAY/PAUSE ►II** to start playback.

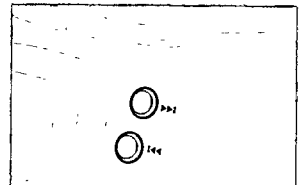

## Finding a passage within a track

1. Press and hold down **SEARCH ◀◀** or **►►**.  
→ The CD is played at high speed and low volume.
2. When you recognize the passage you want, release the **SEARCH** button.

## Different play modes: SHUFFLE/REPEAT

The **CD MODE** button allows you to select 4 different play modes. The modes can be selected or changed during playback.

- During playback, select your play mode by pressing **CD MODE** once or more until the desired play mode appears in the display.
  - SHUFFLE** - All tracks or programme are played in random order.
  - SHUFFLE REPEAT ALL** - Repeats the entire CD or programme in random order.
  - REPEAT** - Plays the current track continuously.
  - REPEAT ALL** - repeats the entire CD or programme
  - You can use **SEARCH** ◀◀ or ▶▶ to skip tracks during CD MODE playback.
- To return to normal playback press **CD MODE** until the various SHUFFLE/ REPEAT modes are no longer shown in the display.
  - You can also press **STOP** ■ to quit the play mode.

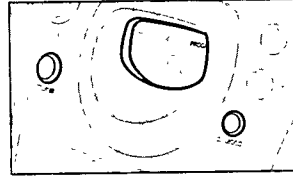

## PROGRAMMING TRACK NUMBERS

You may store up to 20 tracks in the desired sequence. If you like, store any track more than once.

- In the STOP position, press **SEARCH** ◀◀ or ▶▶ for your desired track.
- As soon as your chosen track number is displayed, press **CD MODE** once to store the track.
  - The display will show 'P' briefly and 'PROGRAM', followed by your selected track number.
- Select and store all desired tracks in this way.

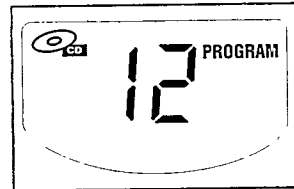

### To review your set programme

- In the stop position, press and hold down **CD MODE** for one second or more.
  - The display will show in sequence all your stored track numbers.
- Start playback of your program by pressing **PLAY/PAUSE** ▶||.

### Erasing a program

You can erase the contents of the memory by:

- pressing the CD door open;
- moving the source selector position;
- pressing **STOP** ■ twice during playback / in stop position
- The display will show 'no' briefly and **PROGRAM**, which disappear when the programme is cancelled.

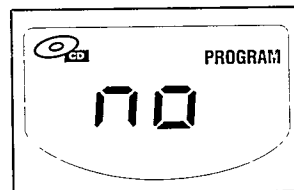

# CASSETTE RECORDER

English

## PLAYING A CASSETTE

1. Set the source selector to **TAPE/OFF**.
2. Press **STOP•OPEN** ■ ▲ to open the cassette holder and insert a cassette.
3. Close the cassette holder.
4. Press **PLAY** ◀ to start playback.
5. Adjust the sound using the **VOLUME, INCREDIBLE SURROUND** and **BASS** controls
6. To interrupt playback press **PAUSE II**. To resume, press the key again.
7. By pressing ◀◀ or ▶▶, fast winding of the tape is possible in both directions. To stop fast winding, press **STOP•OPEN** ■ ▲.
8. To stop the tape, press **STOP•OPEN** ■ ▲.  
→ The keys are automatically released at the end of the tape, except if **PAUSE II** has been activated.
9. With the source selector in **TAPE/OFF** position, the set is switched off when all the cassette keys are released.

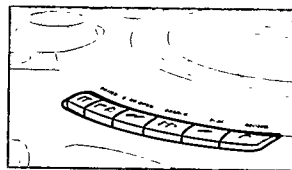

## General information on cassette recording

- Recording is permissible insofar as copyright or other rights of third parties are not infringed.
- This deck is not suitable for recording on CHROME (IEC II) or METAL (IEC IV) type cassettes. For recording you should use NORMAL type cassettes (IEC I) on which the tabs have not been broken.
- The recording level is set automatically. Altering the VOLUME, INCREDIBLE SURROUND and bass controls will not affect the recording in progress.
- At the very beginning and end of the tape, no recording will take place during the 7 seconds, when the leader tape passes the recorder heads.
- To protect a tape from accidental erasure have the tape in front of you and break out the left tab. Recording on this side is no longer possible. To record over this side again, cover the tabs with a piece of adhesive tape.

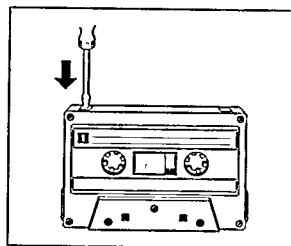



# CASSETTE RECORDER

English

## SYNCHRO START CD RECORDING

1. Set the source selector to **CD**.
2. Insert a CD and if desired, program track numbers.
3. Press **STOP•OPEN** ■ ▲ to open the cassette holder.
4. Insert a blank tape.
4. Close the cassette holder.
5. Press **RECORD** ● to start recording.  
→ Playing of the CD programme starts automatically from the beginning of the programme. It is not necessary to start the CD player separately.
6. For brief interruptions, press **PAUSE** II. To resume recording, press **PAUSE** II again.
7. To stop recording press **STOP•OPEN** ■ ▲.

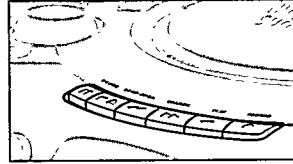

### To select and record a particular passage within a track

1. During playback, press and hold down the **SEARCH** button ◀◀ or ▶▶ to find your passage.
2. Press **PAUSE** II to put the CD player on pause at the selected passage.  
→ Recording will begin from this exact point in the track when you press **RECORD** ●.

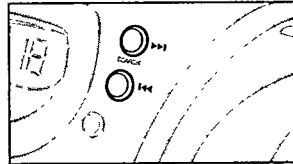

## RECORDING FROM THE RADIO

1. Set the source selector to **MW/FM**
2. Tune to the desired radio station using (See **RADIO RECEPTION**).
3. Press **STOP•OPEN** ■ ▲ to open the cassette holder and insert a blank tape
4. Close the cassette holder.
5. Press **RECORD** ● to start recording.
6. For brief interruptions, press **PAUSE** II. To resume recording, press **PAUSE** II again.
7. To stop recording, press **STOP•OPEN** ■ ▲.

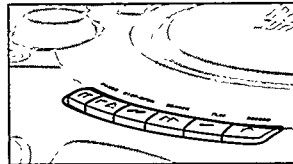

# MAINTENANCE

English

## PRECAUTIONS & GENERAL MAINTENANCE

- Place the set on a hard, flat surface so that the system does not tilt.
- Do not expose the set, CDs, batteries or cassettes to humidity, rain, sand or excessive heat caused by heating equipment or direct sunlight.
- Do not cover the set. Adequate ventilation with a minimum gap of 15 cms between the ventilation holes and surrounding surfaces is necessary to prevent heat build-up.
- The mechanical parts of the set contain self-lubricating bearings and must not be oiled or lubricated.
- To clean the set, use a soft, slightly dampened chamois leather. Do not use any cleaning agents containing alcohol, ammonia, benzene or abrasives as these may harm the housing.

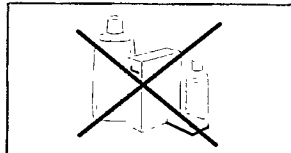
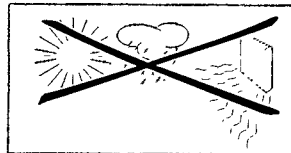

## CD PLAYER AND CD HANDLING

- The lens of the CD player should *never be touched*.
- Sudden changes in the surrounding temperature can cause condensation to form and the lens of your CD player to cloud over. Playing a CD is then not possible. Do not attempt to clean the lens but leave the set in a warm environment until the moisture evaporates.
- Use only Digital Audio CDs
- To take a CD out of its box, press the centre spindle while lifting the CD. Always pick up the CD by the edge and replace the CD back in its box after use to avoid scratching and dust.
- To clean the CD, wipe in a straight line from the centre towards the edge using a soft, lint-free cloth. Do not use cleaning agents as they may damage the disc.
- *Never write* on a CD or attach stickers to it.

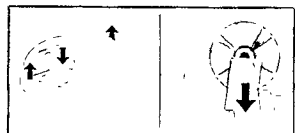

## TAPE DECK MAINTENANCE

To ensure a good recording and playback of the tape deck, clean parts (A), (B) and (C) show in the diagram below, after approx. 50 hours of operation, or on average once a month. Use a cotton bud slightly moistened with alcohol or a special head cleaning fluid to clean both decks.

- Open the cassette holder by pressing **STOP•OPEN** ■ ▲.
- Press **PLAY** ◀ and clean the rubber pressure rollers (C).
- Press **PAUSE** || and clean the magnetic heads (A) and also the capstans (B).
- After cleaning, press **STOP•OPEN** ■ ▲.

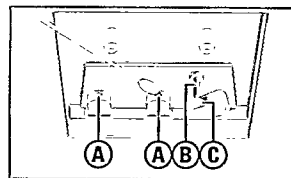

Cleaning of the heads can also be done by playing a cleaning cassette through once.

If a fault occurs, first check the points listed below before taking the set for repair. If you are unable to remedy a problem by following these hints, consult your dealer or service centre.

**WARNING:** *Under no circumstances should you try to repair the set yourself, as this would invalidate the guarantee.*

## **PROBLEM**

---

– *POSSIBLE CAUSE*

• REMEDY

### **No sound/power**

---

– *VOLUME is not adjusted.*

• Adjust the VOLUME.

– *Headphones are connected.*

• Disconnect headphones.

– *Mains lead not securely connected.*

• Connect the AC mains lead properly.

– *Batteries exhausted.*

• Insert fresh batteries.

– *Batteries incorrectly inserted.*

• Insert the batteries correctly.

### **Display does not function properly/ No reaction to operation of any of the controls**

---

– *Electrostatic discharge*

• Switch off set, disconnect the mains plug and reconnect after a few seconds.

### **CD playback does not work**

---

– *CD is badly scratched or dirty.*

• Replace or clean the CD, see Maintenance.

– *Laser lens steamed up*

• Wait until lens has acclimatized

### **The CD skips tracks**

---

– *CD is damaged or dirty.*

• Replace or clean the CD.

– *SHUFFLE or PROGRAM is active.*

• Quit SHUFFLE/PROGRAM mode(s).

### **Poor cassette sound quality**

---

– *Dust and dirt on the heads, etc.*

• Clean deck parts etc., see maintenance.

– *Use of incompatible cassette types (METAL or CHROME).*

• Only use NORMAL (IEC I) for recording.

### **Recording does not work**

---

– *Cassette tab(s) may be broken out.*

• Apply a piece of adhesive tape over the missing tab space.

*The type plate is located on the bottom of the set.*

# AUSTRALIA

## Philips product warranty for Australia

Warranty conditions valid for Colour Television, Video Cassette Recorders, Audio Systems, and Portable Audio.

The benefits given to the purchaser by this warranty are in addition to all other rights and remedies which the purchaser has in respect of the product under the Trade Practices Act or other Commonwealth or State Law.

Philips Sound and Vision warrants its products to the purchaser as follows and subject to the stated conditions.

### 12 months free service

Any defect in materials or workmanship in the product occurring within 12 months from the original date of purchase will be rectified free of charge by Philips Service or one of our authorised service centers.

### Conditions of warranty

1. All claims for warranty service should be made to your nearest Philips Service Branch or to a Philips authorised service dealer. Reasonable evidence of date of purchase must be provided.
2. This warranty extends only to defects occurring under normal use of the product when operated in accordance with the instructions.
3. Home service within the normal service area of Philips Service or one of our authorised service centres will be provided for television receivers with screen size 59cm and above. All other products are to be brought or sent to your nearest Philips Service Branch or to an authorised service centre.
4. This warranty does not cover:
  - a) Mileage or traveling time, pickup or delivery, cost of insurance.
  - b) Service costs arising from failure to correctly adjust the controls of the product or to observe the instructions, or inspections that reveal that the product is in normal working order.
  - c) Product failures caused by misuse, neglect, normal wear and tear, accidental breakage, transit damage, inexpert repairs or modification by unauthorised persons, lightning strikes, vermin infestation or liquid spillage.
  - d) Cleaning of video or audio heads.
  - e) Inadequate receiving antennae.
  - f) Replacement of worn or used batteries, styli or other consumables.

The conditions contained in this warranty replace and override the provisions of the World-Wide Guarantee for Products sold in Australia.

### Philips Service Branches

To contact your nearest Philips Service Branch call **13 13 92** from anywhere in Australia.

#### Sydney

Technology Park  
Australia Centre  
3 Figtree Drive  
Homebush NSW 2140

#### Newcastle & Central Coast

984 Hunter Street  
Newcastle West NSW 2302

#### Perth

1 Fredrick Street  
Belmont WA 6104

#### Melbourne

Cnr Wellington &  
Springvale Roads  
Mulgrave VIC 3170

#### Brisbane

10 Graystone Street  
Tingalpa QLD 4173

#### Also Service Centres: Adelaide

348 Torrens Road  
Croydon Park SA 5008

#### Hobart

2A Pierce Street  
Moonah TAS 7009

#### Wollongong

1/216 Corimal Street  
Wollongong NSW 2500

#### Canberra

Unit F,  
66-70 Maryborough Street  
Fyshwick ACT 2609

Service is also provided through 1,200 accredited service dealers throughout Australia. To find out about your nearest centre, call **13 13 92**.

## Call us direct on the Philips Customer Helpline

Philips customer care lasts as long as you keep the product. Whenever you need any information on the care or operation of your product, remember it's always best to go straight to the source. Phone Philips Helpline direct on

**13 13 91**

**7 days a week**

— your call is always welcome.

Please record the following information for your records and keep in a safe place.

Model No:.....

Serial No:.....

***Please retain your purchase  
receipt which is required to  
claim service under warranty.***

Philips Electronics Australia Limited  
ACN 008 445 743, 3 Figtree Drive  
Homebush NSW 2140

Version 2, 08/97, FFCP-030

# CERTIFICADO DE GARANTIA PARA O BRASIL

(Os dados deste manual estão sujeitos a alterações.)

Este aparelho é garantido pela PHILIPS DA AMAZÔNIA INDÚSTRIA ELETRÔNICA LTDA, por um período superior ao estabelecido por lei, porém, para que a garantia tenha validade, é imprescindível que, além deste certificado, seja apresentada a nota fiscal de compra do produto.

**1) A PHILIPS DA AMAZÔNIA INDÚSTRIA ELETRÔNICA LTDA.** assegura ao proprietário consumidor deste aparelho a garantia de 365 dias (90 dias legal mais 275 dias adicional) **CONTADOS A PARTIR DA DATA DE ENTREGA DO PRODUTO, CONFORME EXPRESSO NA NOTA FISCAL DE COMPRA**, que passa a fazer parte deste certificado.

**2) Esta garantia perderá sua validade se:**

**A) O defeito apresentado for ocasionado por uso indevido ou em desacordo com o seu manual de instruções.**

**B) O produto for alterado, violado ou consertado por pessoa não autorizada pela Philips.**

**C) O produto for ligado a fonte de energia (rede elétrica, pilhas, bateria, etc.) de características diferentes das recomendadas no manual de instruções e/ou no produto.**

**D) O número de série que identifica o produto estiver de alguma forma adulterado ou rasurado.**

**3) Estão excluídos desta garantia defeitos decorrentes do descumprimento do manual de instruções do produto, de casos fortuitos ou de força maior, bem como aqueles causados por agentes da natureza e acidentais.**

**4) Excluem-se igualmente desta garantia defeitos decorrentes do uso dos produtos em serviços não doméstico/residencial regular ou em desacordo com o uso recomendado.**

**5) Nos municípios onde não exista oficina autorizada de serviço Philips, as despesas de transporte do aparelho e/ou do técnico autorizado, correm por conta do Sr. consumidor requerente do serviço.**

**6) Este produto tem GARANTIA INTERNACIONAL.** O serviço técnico (durante ou após a garantia) é disponível em todos os países onde este produto é oficialmente distribuído pela Philips. Nos países onde a Philips não distribui este produto, o serviço técnico da Philips local poderá prestar tal serviço, contudo poderá ocorrer algum atraso no prazo de atendimento se a devida peça de reposição e o manual técnico não forem prontamente disponíveis.

**7) A garantia não será válida se o produto necessitar de modificações ou adaptações para habilitá-lo a operar em qualquer outro país que não aquele para o qual foi designado, fabricado, aprovado e/ou autorizado, ou ter sofrido qualquer dano decorrente deste tipo de modificação.**

PHILIPS DA AMAZÔNIA  
INDÚSTRIA ELETRÔNICA LTDA.

Dentro do Brasil, para informações adicionais sobre o produto ou para eventual necessidade de utilização da rede de oficinas autorizadas, ligue para o CENTRO DE INFORMAÇÕES AO CONSUMIDOR, TEL 0800-123123 (discagem direta gratuita) ou escreva para a Caixa Postal 65106 – CEP 01390-970 – SÃO PAULO – SP.

Horário de atendimento: de segunda à sexta-feira, das 08:00 às 20:00 h, aos sábados das 08:00 às 13:00 h.

Para atendimento fora do Brasil, contate a Philips local ou a:

PHILIPS CONSUMER SERVICE  
BEUKENLAAN 2  
5651 CD EINDHOVEN  
THE NETHERLANDS



## **POLIZA DE GARANTÍA**

### **ESTA POLIZA ES GRATUITA**

Este aparato ha sido cuidadosamente diseñado y se ha fabricado con los mejores materiales bajo un estricto control de calidad, garantizando su buen funcionamiento por los periodos establecidos según el aparato (ver lista en la parte inferior) **a partir de la entrega del aparato al consumidor. Esta póliza incluye la reparación o reposición gratuita de cualquier parte o componente que eventualmente fallase y la mano de obra necesaria para su reparación**, misma que se hará efectiva en cualquiera de nuestros centros de servicio autorizados en el país

Si su aparato llegase a requerir de nuestro servicio de garantía, acuda al centro de servicio más cercano a su domicilio, de tener alguna duda por favor llame a nuestra central de servicio al tel.: 7284252, y en el interior del país LADA sin costo al 01 800 506 9200 en donde con gusto le indicaremos el centro de servicio autorizado más cercano a su domicilio.

PHILIPS MEXICANA S.A. de C.V. a través de sus centros de servicio autorizados **reparará y devolverá a usted su aparato en un plazo no mayor a 20 días hábiles**, contados a partir de la fecha de ingreso, impresa en la orden de servicio de cualquiera de nuestros centros de servicio autorizados.

**La garantía de esta póliza cubre cualquier desperfecto o daño eventualmente ocasionado por los trabajos de reparación y/o traslado del aparato en el interior de nuestros centros de servicio autorizados.**

**Esta póliza sólo tendrá validez, si está debidamente requisitada, sellada y firmada por la casa vendedora**, en caso de extravío de esta póliza, podrá hacer efectiva su garantía con la presentación de su factura de compra.

### **ESTA POLIZA NO SE HARÁ EFECTIVA EN LOS SIGUIENTES CASOS:**

- Cuando el aparato sea utilizado en condiciones anormales y los daños o desperfectos que manifieste sean causados por mal trato, descuido o mal uso.
- Cuando el aparato no haya sido operado de acuerdo a su instructivo de uso, en donde se señalan las condiciones normales de operación, los valores nominales y las tolerancias de las tensiones (voltaje), frecuencia (ciclaje) de alimentación eléctrica y las características que deben reunir las instalaciones auxiliares
- Cuando la causa de la falla o mal funcionamiento sea consecuencia de una reparación inadecuada o alteración producida por personas no autorizadas por PHILIPS MEXICANA S.A. de C.V.
- Cuando los datos de esta póliza hayan sido alterados o modificados.
- Por fenómenos naturales no imputables a la empresa tales como: temblores, inundaciones, incendios, descargas eléctricas, rayos, etc.

### **PERIODOS DE GARANTÍA**

**12 MESES.** – Televisores, videocaseteras, proyectores, cámaras de video, decodificadores de señal (IRD), TV, hotel, sistemas de observación, televisores de proyección, teléfonos celulares, pagers, equipos modulares, sintonificadores

**6 MESES.** – Radio grabadoras con y sin compact disc, mini reproductores de cassette, reproductor de CD portátil, radio relojes, radios A.M.F.M., auto estéreos, teléfonos inalámbricos.

**3 MESES.** – Accesorios, controles remotos y bocinas.

## Philips Mexicana, S.A. de C.V.

**Producto importado por**  
Philips Mexicana, S.A. de C.V.  
Norte 45 No. 669 Col. Ind. Vallejo  
Del Azcapotzalco C.P. 02300  
Tels. 7284200 y 7294800

**Centro de Información al Consumidor:**  
Norte 45 No. 669 Col. Ind. Vallejo  
Del Azcapotzalco C.P. 02300  
Tels. 3687788 Lada 01 8005046200

**Centro de Servicio Vallejo:**  
Norte 45 No. 669 Col. Ind. Vallejo  
Del Azcapotzalco C.P. 02300  
Tel. 3682033

En caso que en su producto se produzca alguna falla, acuda al centro de servicio más cercano a su domicilio (según listado de talleres), de tener alguna duda, por favor llame a nuestra CENTRAL DE SERVICIO, en donde con gusto le atenderemos

Asimismo cuando requiera refacciones y partes originales para su producto, acuda a los mismos centros de servicio. Para hacer efectiva la garantía de su producto, es necesario que presente usted esta póliza debidamente registrada o de lo contrario presentar su factura de compra.

Modelo \_\_\_\_\_ N° de Serie \_\_\_\_\_ La presente garantía contará a partir de \_\_\_\_\_ día \_\_\_\_\_ mes \_\_\_\_\_ año

Ciudad	EDD	Calle y N°	Colonia	C. P.	Nombre Comercial	Lada	Telefono	Fax
Aguascalientes	AGU	Av. Revolución N. 28	M. Alvarado	20900	Servicio Electronico Profesional	74	83 32 56	-
Aguascalientes	AGU	Barranca de Obispo 3011	Pradera Dorada	20900	Teléfonos de Demarcación	16	18 21 28	18 21 28
Aguascalientes	AGU	Rosales de Guerrero Esq. 5 de Febrero	Prof. Longoria	20900	Centro de Servicio Logos	632	492 43	-
Aguascalientes	AGU	Tecun y Potosí N. 3038-A	San Felipe	21240	Zenit Electronica	14	14 01 16	26 50 41
Aguascalientes	AGU	Francisco Moreno N. 426	Centro	20900	TV Antenas de Colim	331	403 01	403 01
Aguascalientes	AGU	Venustiano Carranza N. 140-A Nte	Centro	20900	Estereo Voz	67	16 15 10	-
Aguascalientes	AGU	Av. Vallarta N. 2250	Ladron de Guisano	44800	Leoban S.A. de C.V.	3	616 18 63 616 01 26	616 72 62
Aguascalientes	AGU	Hermosillo Alvarez N. 726	San Juan de Dios	37480	Tecnos Especializadas	47	47 70 26-59	15 58 64
Aguascalientes	AGU	Calle 70 N. 443 X 49 Depto. 8	Centro	97600	Serv. centro	99	28 54 28	23 39 97
Aguascalientes	AGU	Calle Cosahuatlan N. 895-2	Cosahuatlan Nte	21200	Baja Electronica	619	67 49 16	67 49 16
Aguascalientes	AGU	Norte 45 N. 659	Industrial Vallejo	2300	Philips Mexicana S.A. de C.V.	5	358 20 33	728 42 72
Aguascalientes	AGU	Calle Vallejo N. 634 Tec. 5	Industrial Vallejo	2300	Tecnología y Servicio S.A. de C.V.	5	597 57 99	597 57 99
Aguascalientes	AGU	Pedregal N. 519 Local C-3	Dol Valle	03100	Cooperativa Pines	5	605 42 15 605 42 67	605 43 46
Aguascalientes	AGU	Juan Méndez N. 825 Nte	Centro	64000	Monterrey Centro Electronico S.A.	8	375 16 17	374 85 42
Aguascalientes	AGU	Logos de Patzcuaro N. 250-A	Ventura Puente	55320	Multiserv Prof. de Zentora	43	12 03 17	-
Aguascalientes	AGU	Huizales N. 207	Centro	65000	El Francistor S. de R.L. de C.V.	951	647 37	-
Aguascalientes	AGU	Pza. de las Américas Lote 28 Módulo D	Valle de San Juan	42035	Frazer Electronica	77	14 15 81	-
Aguascalientes	AGU	Av. 10 Poniente N. 2532-B	San Alejandro	72090	Concesionario Philips de Puebla	22	30 34 39	-
Aguascalientes	AGU	Bolivia 32	Lomas de Quetzacoatl	78190	Electronica Zenit	421	610 09	-
Aguascalientes	AGU	Fuente de La Grana N. 147	Balcones del Valle	78320	Servicios Electronicos	481	534 07	-
Aguascalientes	AGU	Loredo N. 165	Mazateco	65190	Concesionario Philips Toluca	12	12 38 04	-
Aguascalientes	AGU	Calle 1a N. 1540-3	Centro	22000	Sistemas Instalaciones de Computacion	65	65 95 59	65 95 59
Aguascalientes	AGU	Calle Toluca N. 505	Sanchez	50340	Concesionario Philips Toluca	72	14 83 09	17 03 21
Aguascalientes	AGU	Manana Lopez Ortiz N. 1126 Nte	Centro	27000	Electronica Jomar	17	22 00 05	-
Aguascalientes	AGU	10 Nte. Ote 153-A	Centro	28100	KC-Medico	99	18 19 03	-
Aguascalientes	AGU	Av. Costa Verde N. 1116	Fracc. Costa Verde	94234	Servicios Esp. en Electronica	29	21 07 02	21 07 02
Aguascalientes	AGU	Sanchez Marrón N. 263	Centro	83600	Tecnos	93	14 31 36	-

# NEW ZEALAND

## Guarantee and Service for New Zealand

---

Thank-you for purchasing this quality Philips product. Philips New Zealand Ltd guarantees this product against defective components and faulty workmanship for a period of 12 months. Any defect in materials or workmanship occurring within 12 months from the date of purchase subject to the following conditions will be rectified free of charge by the retailer from whom this product was purchased.

### Conditions

1. The product must have been purchased in New Zealand. As proof of purchase, retain the original sales docket indicating the date of purchase.
2. The guarantee applies only to faults caused by defective components, or faulty workmanship on the part of the manufacturer.
3. The guarantee does not cover failures caused by misuse, neglect, normal wear and tear, accidental breakage, use on the incorrect voltage, use contrary to operating instructions, or unauthorised modification to the product or repair by an unauthorised technician.

4. Reasonable evidence (in the form of a sales docket) must be supplied to indicate that the product was purchased no more than 12 months prior to the date of your claim.
5. In the event of a failure, Philips shall be under no liability for any injury, or any loss or damage caused to property or products other than the product under guarantee.

This guarantee does not prejudice your rights under common law and statute, and is in addition to the normal responsibilities of the retailer and Philips.

### How to claim

Should your Philips product fail within the guarantee period, please return it to the retailer from whom it was purchased. In most cases the retailer will be able to satisfactorily repair or replace the product.

However, should the retailer not be able to conclude the matter satisfactorily, or if you have other difficulties claiming under this guarantee, please contact

**The Guarantee Controller  
Philips New Zealand Ltd.**

✉ P.O. Box 41.021

Auckland

☎ (09) 84 94 160

fax ☎ (09) 84 97 858



---

1  
2  
3  
4  
5  
6  
7  
8  
9  
10  
11  
12  
13  
14  
15  
16  
17  
18  
19  
20  
21  
22  
23  
24  
25  
26  
27  
28  
29  
30  
31  
32  
33  
34  
35  
36  
37  
38  
39  
40  
41  
42  
43  
44  
45  
46  
47  
48  
49  
50  
51  
52  
53  
54  
55  
56  
57  
58  
59  
60  
61  
62  
63  
64  
65  
66  
67  
68  
69  
70  
71  
72  
73  
74  
75  
76  
77  
78  
79  
80  
81  
82  
83  
84  
85  
86  
87  
88  
89  
90  
91  
92  
93  
94  
95  
96  
97  
98  
99  
100

# AZ 2000 - Portable CD Radio Recorder

---

