

CD Radio Cassette Recorder

AZ 1560



*Let's make things better.*



**PHILIPS**

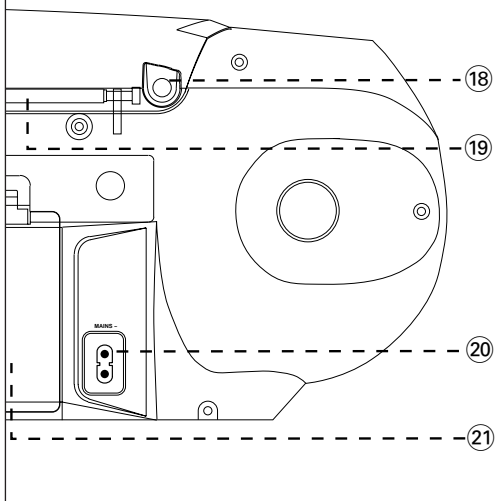
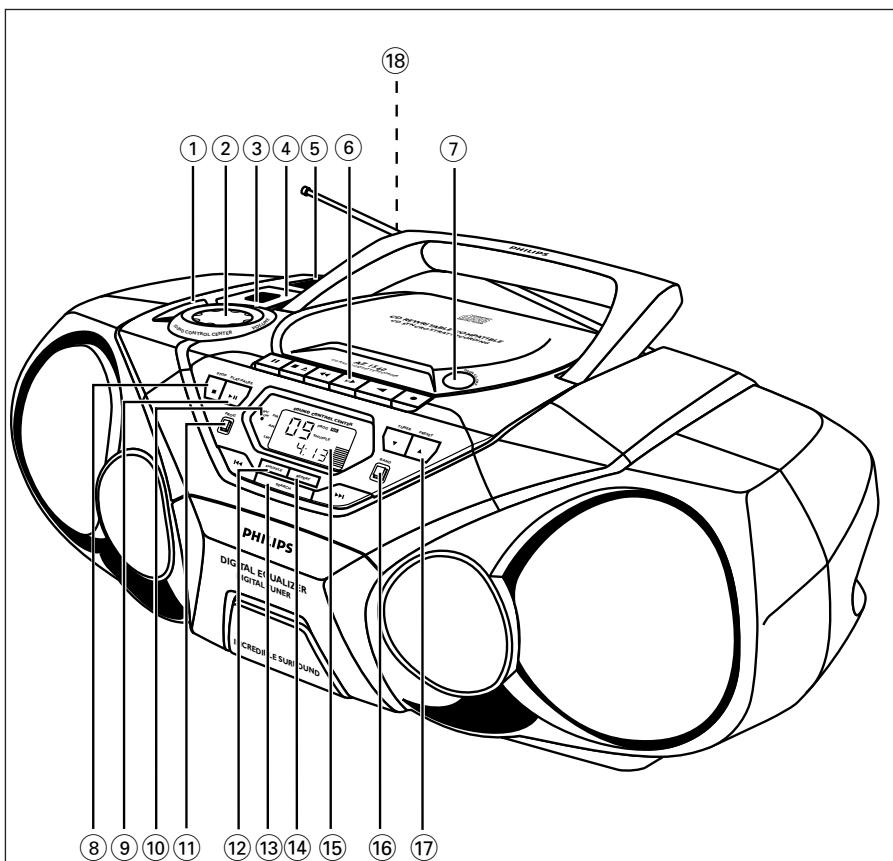

# CONTROLS

## TOP AND FRONT PANELS

- ① **DIGITAL EQUALIZER** – selects volume or the various frequencies for adjustment: volume, bass, mid and high frequencies
- ② **VOLUME/SOUND CONTROL CENTER** – adjusts the volume level and digital equalizer settings
- ③ **DIGITAL DBB (Dynamic Bass Boost)** – enhances the bass
- ④ **INCREDIBLE SURROUND** – creates a super-enhanced stereo effect
- ⑤ **POWER slider** – selects the sound source for CD/ TUNER/ TAPE and also switches the set off
- ⑥ **CASSETTE RECORDER keys:**
  - RECORD ●** – starts recording
  - PLAY ◀** – starts playback
  - SEARCH ◀◀, ▶▶** – fast winds/rewinds the tape
  - OPEN•STOP ▲ ■** – opens the cassette compartment
    - stops the tape;
  - PAUSE II** – interrupts recording or playback
- ⑦ **OPEN•CLOSE** – opens/ closes the CD door
- ⑧ **STOP ■** – stops CD playback or erase a CD programme
- ⑨ **PLAY•PAUSE ▶II** – starts or interrupts CD playback
- ⑩ **BATT LOW** – indicates when battery power is running low

- ⑪ **PROG** – CD: programmes tracks and reviews the programme;  
Tuner: programmes preset tuner stations
- ⑫ **SHUFFLE** – plays CD tracks in random order
- ⑬ **SEARCH ◀◀, ▶▶**
  - Tuner: - (down, up) tunes to radio stations;
  - CD: - searches back and forward within a track;
    - skips to the beginning of a current track/ previous/ subsequent track
- ⑭ **REPEAT** – repeats a track / CD programme / entire CD
- ⑮ **Display** – shows the status of the set
- ⑯ **BAND** – selects waveband
- ⑰ **TUNER PRESET ▼, ▲** – selects a preset tuner station (down, up)

## BACK PANEL

- ⑱  – 3.5 mm headphone socket
- ⑲ **Telescopic aerial** – improves FM reception
- ⑳ **AC MAINS** – inlet for mains cord
- ㉑ **Battery door**

## Environmental information

All unnecessary packaging material has been omitted. We have done our utmost to make the packaging easy to separate into three mono-materials: cardboard (box), expandable polystyrene (buffer), polyethylene (bags, protective foam).

**Your set consists of materials which can be recycled if disassembled by a specialized company. Please observe the local regulations regarding the disposal of packing materials, exhausted batteries and old equipment.**

Whenever convenient, use the power supply if you want to conserve battery life. Make sure you remove the plug from the set and wall socket before inserting batteries.

## BATTERIES (OPTIONAL)

1. Open the battery compartment and insert six batteries, type **R-20, UM-4** or **D-cells**, (preferably alkaline) with the correct polarity as indicated by the "+" and "-" symbols inside the compartment.
  2. Replace the compartment door, making sure the batteries are firmly and correctly in place. The set is now ready to operate.
- If **BATT LOW** lights up, battery power is running low.
    - The **BATT LOW** indicator eventually goes out if the batteries are too weak.
  - *Incorrect use of batteries can cause electrolyte leakage and will corrode the compartment or cause the batteries to burst. Therefore:*
    - *Do not mix battery types, e.g. alkaline with carbon zinc. Only use batteries of the same type for the set.*
    - *When inserting new batteries, do not try to mix old batteries with the new ones.*
    - *Remove the batteries if the set is not to be used for a long time.*
    - **Batteries contain chemical substances, so they should be disposed of properly**

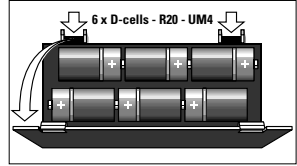

*For users in the U.K.: please follow the instructions on page 2.*

## USING AC POWER

1. Check if the mains voltage **as shown on the type plate located on the bottom of the set**, corresponds to your local power supply. If it does not, consult your dealer or service centre.
2. If your set is equipped with a voltage selector, adjust the selector so that it matches with the local mains.
3. Connect the mains lead to the wall socket and the set is now ready for use.
4. To disconnect the set from the mains completely, remove the plug from the wall socket.

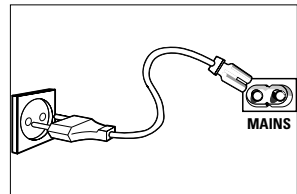

## SWITCHING ON AND OFF

- Adjust the **POWER** slider to the desired sound source: **CD**, **TUNER** or **TAPE**.
- The set is switched off when the **POWER** slider is in the **TAPE/OFF** position and the keys on the tape deck are released.
- The volume, sound settings and tuner presets will be retained in the set's memory.

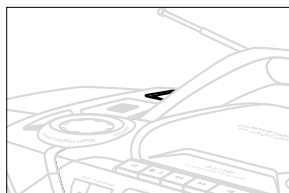

## ADJUSTING VOLUME AND SOUND

1. Turn the **VOLUME/ SOUND CONTROL CENTER** control clockwise to increase or anti-clockwise to decrease volume on the set.  
→ Display shows the volume level indication, **VOL** and a number from 0-32.
2. To adjust the bass, mid and high frequency levels, press **DIGITAL EQUALIZER** once or more until the desired option is displayed. While the option is shown, turn the **VOLUME/ SOUND CONTROL CENTER** control to increase or decrease (- 5 to + 5 steps maximum) the desired tone.  
→ **VOLUME** can also be adjusted in this way with a level range from 0-32.
3. Press **DIGITAL DBB** to switch dynamic bass boost on or off.  
→ If on, the **DIGITAL DBB** light goes on.
4. Press **INCREDIBLE SURROUND** to switch the surround sound effect on or off.  
→ If on, the **INCREDIBLE SURROUND** light goes on.

**Note:** The effect of **INCREDIBLE SURROUND** may vary with different types of music.

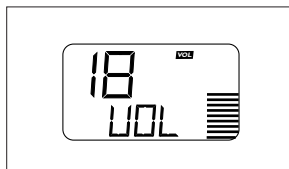
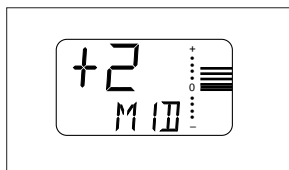
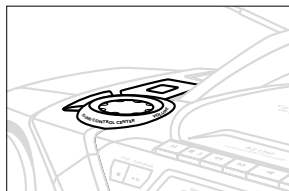

## TUNING TO RADIO STATIONS

1. Select **TUNER** source.  
→ **FM** is displayed briefly and then the radio station frequency is shown.
2. Press **BAND** once or more to select your waveband.
3. Press **SEARCH** **◀** or **▶** and release when the frequency in the display starts running.  
→ The **TUNER** automatically tunes to a station of sufficient reception. Display shows **Srch** during automatic tuning.  
→ If an FM station is received in stereo, **STEREO** is shown.
4. Repeat step **3** if necessary until you find the desired station.
  - To tune to a weak station, press **SEARCH** **◀** or **▶** briefly and repeatedly until you have found optimal reception.

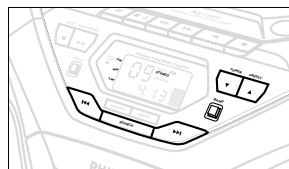

**To improve radio reception:**

- For **FM**, pull out the telescopic aerial. Incline and turn the aerial. Reduce its length if the signal is too strong (very close to a transmitter).
- For **MW (AM)**, **LW**, the set is provided with a built-in aerial so the telescopic aerial is not needed. Direct the aerial by turning the whole set.

**Programming tuner stations**

You can store up to a total of 30 tuner stations in the memory.

1. Tune to your desired station (see Tuning to radio stations).
2. Press **PROG** to activate programming.  
→ Display: **PROG** flashes.
3. Press **PRESET ▲** or **▼** once or more to allocate a number from 1 to 30 to this station.
4. Press **PROG** again to confirm the setting.  
→ Display: **PROG** disappears, the preset number and the frequency of the preset station are shown.
5. Repeat the above four steps to store other stations.
  - You can overwrite a preset station by storing another frequency in its place.

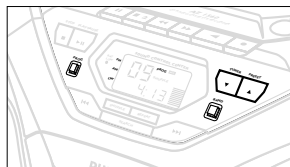
**Tuning to preset stations**

Press **TUNER PRESET ▼** or **▲** until the desired preset station is displayed.

**Changing tuning grid (some versions only)**

In North and South America the frequency step between adjacent channels in the AM and FM band are **10 KHz** and **100 KHz** respectively. In the rest of the world this step is **9 KHz** and **50 KHz**. Usually the frequency step has been preset in the factory for your area.

1. Check that the set is in the **TAPE/OFF** position and switched off.
  2. *To select 9KHz:* Simultaneously, press **PROG** and **REPEAT**
  3. Switch the set on to **TUNER** and then release the controls.
    - *To select 10KHz:* Repeat steps **1-3** but in step **2**, simultaneously, press **PROG** and **TUNING ►►** on the set.
- When you tune to radio stations, the display shows tuning in either steps of **9** or **10**.
- All preset stations will be affected and you may need to reprogramme the preset stations.

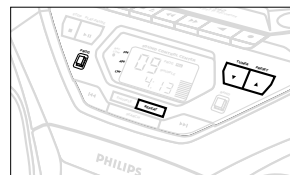

# CD PLAYER

## Playing a CD

1. Select **CD** source.

2. Press **OPEN•CLOSE** to open the CD door.

→ Display:  $\overline{\text{CD}}$   
 $\text{OPEN}$  when you open the CD door.

3. Insert a CD or CD-R(W) with the printed side facing up and press **OPEN•CLOSE** to close the CD door.

→ Display:  $\overline{\text{CD}}$  15C as the CD player scans the contents of a CD.

The total number of tracks and playing time are then shown.

→ Display:  $\overline{\text{CD}}$  15C  
 $\overline{\text{CD}}$  15C is shown if the CD R(W) is not finalised.

4. Press **PLAY•PAUSE ►II** to start playback.

→ Display: Current track number and elapsed playing time of the track during CD playback.

5. To interrupt playback press **PLAY•PAUSE ►II**. Press

**PLAY•PAUSE ►II** again to resume play.

→ The display freezes and the elapsed playing time flashes when playback is paused.

6. To stop CD playback, press **STOP ■**.

**Note:** CD play will also stop when:

- the CD door is opened;
- the CD has reached the end (unless you have selected REPEAT ALL);
- you select another source: TAPE / TUNER.

## Selecting a different track

• Press **SEARCH ◀◀** or **▶▶** once or repeatedly until the desired track number appears in the display.

• If you have selected a track number shortly after loading a CD or in the PAUSE position, you will need to press **PLAY•PAUSE ►II** to start playback.

## Finding a passage within a track

1. Press and hold down on **SEARCH ◀◀** or **▶▶**.

– The CD is played at high speed and low volume.

2. When you recognize the passage you want, release **SEARCH ◀◀** or **▶▶**.

– Normal playback continues.

**Note:** During a CD programme or if SHUFFLE/ REPEAT active, searching is only possible within a track.

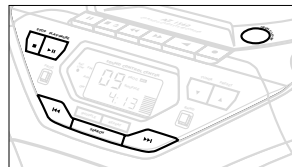

## Different play modes: SHUFFLE and REPEAT

You can select and change the various play modes before or during playback. The play modes can also be combined with PROGRAM.

**SHUFFLE** - tracks of the entire CD/ programme are played in random order

**SHUFFLE** and **REPEAT ALL** - to repeat the entire CD/ programme continuously in random order

**REPEAT ALL** - to repeat the entire CD/ programme

**REPEAT** and **SHUFFLE REPEAT** - plays the current (random) track continuously

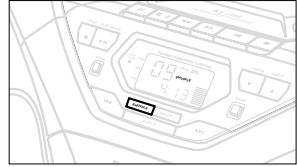

1. To select your play mode, press the **SHUFFLE** or **REPEAT** button before or during playback until the display shows the desired function.
2. Press **PLAY•PAUSE ►II** to start playback if in the STOP position.
  - Playback starts immediately if you have selected a SHUFFLE mode.
3. To return to normal playback, press the respective **SHUFFLE** or **REPEAT** button until the various SHUFFLE / REPEAT modes are no longer displayed.
  - You can also press **STOP ■** to cancel your play mode.

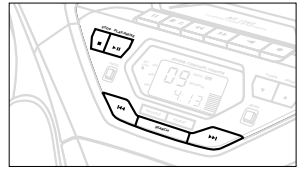

## Programming track numbers

Programme in the STOP position to select and store your CD tracks in the desired sequence. If you like, store any track more than once. Up to 20 tracks can be stored in the memory.

1. Press **SEARCH ◀◀ ▶▶** once or more to select your desired track number.
2. Press **PROG**.
  - Display: **PROG** and the selected track number. **PROG** appears briefly.
  - If you attempt to programme without first selecting a track number, **SEL** is shown.
3. Press **PROG** to confirm the track number to be stored.
4. Repeat steps **1-2** to select and store all desired tracks.
  - **FULL** is displayed if you attempt to programme more than 20 tracks.
5. To start playback of your CD programme, press **PLAY•PAUSE ►II**.

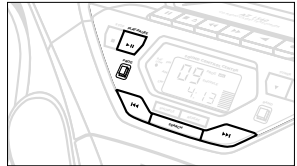

**Note:** if you have selected the tracks during CD playback, first press **STOP ■** then **PLAY•PAUSE ►II**.



### Reviewing the programme

In the stop position or during playback, press and hold down **PROG** for a while until the display shows all your stored track numbers in sequence.

### Erasing a programme

You can erase the programme by:

- pressing **STOP** ■ once in the STOP position;
- pressing **STOP** ■ twice during playback;
- The display shows  $\overline{P} \overline{P} \overline{0} \overline{0}$  briefly and **PROG** disappears.

The programme is also erased by:

- pressing the CD door open;
- selecting another source: TAPE/ TUNER.

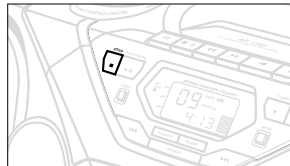

## CASSETTE PLAYBACK

### 1. Select **TAPE** source.

→ The display shows **TAPE** throughout tape operation.

### 2. Press **OPEN•STOP** ▲■ to open the cassette door.

### 3. Insert a recorded cassette and close the cassette door.

### 4. Press **PLAY** ◀ to start playback.

### 5. To interrupt playback press **PAUSE** ■■. To resume, press this key again.

### 6. By pressing **SEARCH** ◀◀ or ▶▶ on the set fast winding of the tape is possible in both directions.

### 7. To stop the tape, press **OPEN•STOP** ▲■.

- The keys are automatically released at the end of the tape, except if **PAUSE** ■■ has been activated.

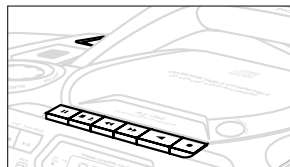

**Note:** The sound source cannot be changed while playing a cassette.



## GENERAL INFORMATION ON RECORDING







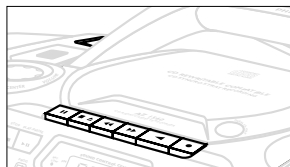

- Recording is permissible insofar as copyright or other rights of third parties are not infringed.
- This deck is not suited for recording on CHROME (IEC II) or METAL (IEC IV) type cassettes. For recording, use only NORMAL type cassettes (IEC I) on which the tabs have not been broken.
- The best recording level is set automatically. Altering the VOLUME, INCREDIBLE SURROUND, DIGITAL EQUALIZER or DBB controls will not affect the recording in progress.
- At the very beginning and end of the tape, no recording will take place during the 7 seconds, when the leader tape passes the recorder heads.
- To protect a tape from accidental erasure, have the tape in front of you and break out the left tab.  
Recording on this side is no longer possible. To record over this side again, cover the tabs with a piece of adhesive tape.

## Synchro Start CD recording

1. Select CD source.
2. Insert a CD and if desired, programme track numbers.
3. Press **OPEN•STOP**  to open the cassette door.
4. Insert a suitable tape into the cassette deck and close the cassette door.
5. Press **RECORD**  to start recording.
  - Playing of the CD programme starts automatically from the beginning of the programme. It is not necessary to start the CD player separately.



## To select and record a particular passage within a track

- Press and hold down on **SEARCH**  or .
  - When you recognize the passage you want, release **SEARCH**  or .
  - To interrupt CD playback press **PLAY•PAUSE** .
  - Recording will begin from this exact point in the track when you press **RECORD** .
6. For brief interruptions during recording, press **PAUSE** . To resume recording, press **PAUSE**  again.
  7. To stop recording, press **OPEN•STOP** .

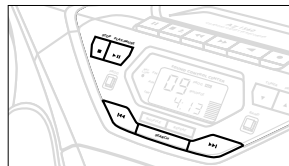

## Recording from the tuner

1. Tune to the desired radio station (see Tuning to radio stations).
2. Press **OPEN•STOP ▲■** to open the cassette door.
3. Insert a suitable tape into the cassette deck and close the cassette door.
4. Press **RECORD ●** to start recording.
5. For brief interruptions, press **PAUSE II**. To resume recording, press **PAUSE II** again.
6. To stop recording, press **OPEN•STOP ▲■**.

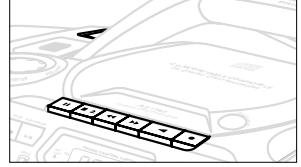

## General maintenance

- Do not expose the set, batteries, CDs or cassettes to humidity, rain, sand or excessive heat caused by heating equipment or direct sunlight.
- To clean the set, use a soft, slightly dampened chamois leather. Do not use any cleaning agents containing alcohol, ammonia, benzene or abrasives as these may harm the housing.

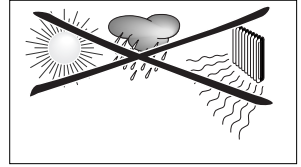

## Safety information

- Place the set on a hard and flat surface so that the system does not tilt. Make sure there is adequate ventilation to prevent the system from overheating.
- The mechanical parts of the set contain self-lubricating bearings and must not be oiled or lubricated.



## CD player and CD handling

- If the CD player cannot read CDs correctly, use a commonly available cleaning CD to clean the lens before taking the set to repair. Other cleaning methods may destroy the lens.
- The lens of the CD player should never be touched!
- Sudden changes in the surrounding temperature can cause condensation to cloud over on the lens of your CD player. Playing a CD is then not possible. Do not attempt to clean the lens but leave the set in a warm environment until the moisture evaporates.
- Always keep the CD compartment closed to avoid dust on the lens.
- To take a CD out of its box, press the centre spindle while lifting the CD. Always pick up the CD by the edge and return the CD to its box after use to avoid scratching and dust.
- To clean the CD, wipe in a straight line from the centre towards the edge using a soft, lint-free cloth. Do not use cleaning agents as they may damage the disc.
- *Never* write on a CD or attach any stickers to it.

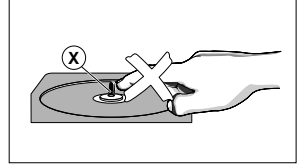

## Tape deck maintenance

To ensure quality recording and playback of the tape deck, clean parts (A), (B) and (C) shown in the diagram below, after approx. 50 hours of operation, or on average once a month. Use a cotton bud slightly moistened with alcohol or a special head cleaning fluid to clean both decks.

1. Open the cassette holder by pressing **OPEN•STOP** ▲■.
2. Press **PLAY** ◀ and clean the rubber pressure rollers (C).
3. Press **PAUSE** || and clean the magnetic heads (A) and also the capstan (B).
4. After cleaning, press **OPEN•STOP** ▲■.

**Note:** *Cleaning of the heads can also be done by playing a cleaning cassette through once.*

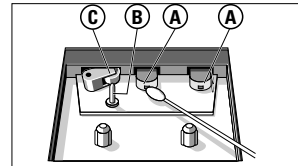

If a fault occurs, first check the points listed below before taking the set for repair. If you are unable to remedy a problem by following these hints, consult your dealer or service centre.

**WARNING: Do not open the set as there is a risk of electric shock. Under no circumstances should you try to repair the set yourself, as this will invalidate the guarantee.**

## PROBLEM

---

– POSSIBLE CAUSE

- REMEDY

## No sound/power

---

– VOLUME not adjusted

- Adjust the VOLUME

– Headphones connected

- Disconnect headphones

– Mains lead not securely connected

- Connect AC mains lead properly

## Severe radio hum or noise

---

– Electrical interference: set too close to TV, VCR or computer

- Increase the distance

## Poor radio reception

---

– Weak radio signal

- FM: Direct the FM telescopic aerial for optimum reception

 **indication**

---

– CD badly scratched or dirty

- Replace/ clean CD, see Maintenance

– Laser lens steamed up

- Wait until lens has cleared

## The CD skips tracks

---

– CD damaged or dirty

- Replace or clean CD

– SHUFFLE or PROGRAM is active

- Switch off SHUFFLE / PROGRAM

## Poor cassette sound quality

---

– Dust and dirt on the heads, etc.

- Clean deck parts, see Maintenance

– Use of incompatible cassette types (METAL or CHROME)

- Only use NORMAL (IEC I) for recording

## Recording does not work

---

– Cassette tab(s) may be broken

- Apply a piece of adhesive tape over the missing tab space.

 **indication**

---

– CD-R(W) is blank or the disc is not finalised

- Use a finalised CD-R(W)

**This product complies with the radio interference requirements of the European Union.  
The type plate is located on the bottom of the set.**