

PHILIPS **MAGNAVOX**

AZ1518 CD Radio Cassette Recorder



Owner's Manual
Mode d'emploi
Instructivo de manejo

Toll Free Help Line
Ligne d'assistance en service libre
Línea de ayuda telefónica sin cargo

800-531-0039



Return your Warranty Registration card today to ensure you receive all the benefits you're entitled to.

- Once your Philips Magnavox purchase is registered, you're eligible to receive all the privileges of owning a Philips Magnavox product.
- So complete and return the Warranty Registration Card enclosed with your purchase at once. And take advantage of these important benefits.

Warranty Verification

Registering your product within 10 days confirms your right to maximum protection under the terms and conditions of your Philips Magnavox warranty.

Owner Confirmation

Your completed Warranty Registration Card serves as verification of ownership in the event of product theft or loss.

Model Registration

Returning your Warranty Registration Card right away guarantees you'll receive all the information and special offers which you qualify for as the owner of your model.

Know these *safety* symbols



 This "bolt of lightning" indicates uninsulated material within your unit may cause an electrical shock. For the safety of everyone in your household, please do not remove product covering.

 The "exclamation point" calls attention to features for which you should read the enclosed literature closely to prevent operating and maintenance problems.

For Customer Use

Enter below the Serial No. which is located on the rear of the cabinet. Retain this information for future reference.

Model No. _____

Serial No. _____

WARNING: TO PREVENT FIRE OR SHOCK HAZARD, DO NOT EXPOSE THIS EQUIPMENT TO RAIN OR MOISTURE.

CAUTION: To prevent electric shock, match wide blade of plug to wide slot, and fully insert.

English

Introduction.....	2	Tuner.....	10-11
Safety instructions.....	5	CD player.....	12-14
Controls.....	6-7	Cassette recorder.....	15-16
Power supply.....	8	General information.....	17
Basic functions.....	9	Troubleshooting.....	18
		Limited warranty.....	19

English

Français

Introduction.....	20	Radio.....	26-27
Conseils de sécurité.....	21	Lecteur de CD.....	28-30
Commandes.....	22-23	Platine cassette.....	31-32
Alimentation.....	24	Informations générales.....	33
Fonctions de base.....	25	Recherche de pannes.....	34
		Garantie limitée.....	35

Français

Español

Introducción.....	36	Radio.....	42-43
Instrucciones sobre seguridad.....	37	Reproductor CD.....	44-46
Controles.....	38-39	Grabadora.....	47-48
Fuente de alimentación.....	40	información general.....	49
Funciones básicas.....	41	Localización de averías.....	50
		Garantía limitada.....	51

Español

Canada

English: This digital apparatus does not exceed the Class B limits for radio noise emissions from digital apparatus as set out in the Radio Interference Regulations of the Canadian Department of Communications.

Français: Cet appareil numérique n'émet pas de bruits radioélectriques dépassant les limites applicables aux appareils numériques de Classe B prescrites dans le Règlement sur le Brouillage Radioélectrique édicté par le Ministère des Communications du Canada.

Mexico

NOM

Es necesario que lea cuidadosamente su instructivo de manejo.



SAFETY INSTRUCTIONS – Read before operating equipment

This product was designed and manufactured to meet strict quality and safety standards. There are, however, some installation and operation precautions which you should be particularly aware of.

1. **Read Instructions** - All the safety and operating instructions should be read before the appliance is operated.
2. **Retain Instructions** - The safety and operating instructions should be retained for future reference.
3. **Heed Warnings** - All warnings on the appliance and in the operating instructions should be adhered to.
4. **Follow Instructions** - All operating and use instructions should be followed.
5. **Water and Moisture** - The appliance should not be used near water - for example, near a bathtub, washbowl, kitchen sink, laundry tub, or swimming pool, or in a wet basement, etc.
6. **Carts and Stands** - The appliance should be used only with a cart or stand that is recommended by the manufacturer.
- 6A.  An appliance and cart combination should be moved with care. Quick stops, excessive force, and uneven surfaces may cause the appliance and cart combination to overturn.
7. **Wall or Ceiling Mounting** - The appliance should be mounted to a wall or ceiling only as recommended by the manufacturer.
8. **Ventilation** - The appliance should be situated so that its location or position does not interfere with its proper ventilation. For example, the appliance should not be situated on a bed, sofa, rug, or similar surface that may block the ventilation openings; or, placed in a built-in installation, such as a bookcase or cabinet that may impede the flow of air through the ventilation openings.
9. **Heat** - The appliance should be situated away from heat sources such as radiators, heat registers, stoves, or other appliances (including amplifiers) that produce heat.
10. **Power Sources** - The appliance should be connected to a power supply only of the type described in the operating instructions or as marked on the appliance.

11. Grounding or Polarization

The precautions that should be taken so that the grounding or polarization means of an appliance is not defeated.

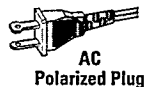

CAUTION: To prevent electric shock, match the wide blade of this plug to the wide slot, fully insert. Do not use this (polarized) plug with an extension cord, receptacle or other outlet unless the blades can be fully inserted to prevent blade exposure.

12. **Power Cord Protection** - Power supply cords should be routed so that they are not likely to be walked on or pinched by items placed upon or against them, paying particular attention to cords and plugs, convenience receptacles, and the point where they exit from the appliance.
13. **Cleaning** - The appliance should be cleaned only as recommended by the manufacturer.
14. **Power Lines** - An outdoor antenna should be located away from power lines.
15. **Nonuse Periods** - The power cord of the appliance should be unplugged from the outlet when left unused for a long period of time.
16. **Object and Liquid Entry** - Care should be taken so that objects do not fall and liquids are not spilled into the enclosure through openings.
17. **Damage Requiring Service** - The appliance should be serviced by qualified service personnel when:
 - A. The power supply cord or the plug has been damaged; or
 - B. Objects have fallen, or liquid has spilled into the appliance; or
 - C. The appliance has been exposed to rain; or
 - D. The appliance does not appear to operate normally or exhibits a marked change in performance; or
 - E. The appliance has been dropped, or the enclosure damaged.
18. **Servicing** - The user should not attempt to service the appliance beyond that described in the operating instructions. All other servicing should be referred to qualified service personnel.

English

CONTROLS

English

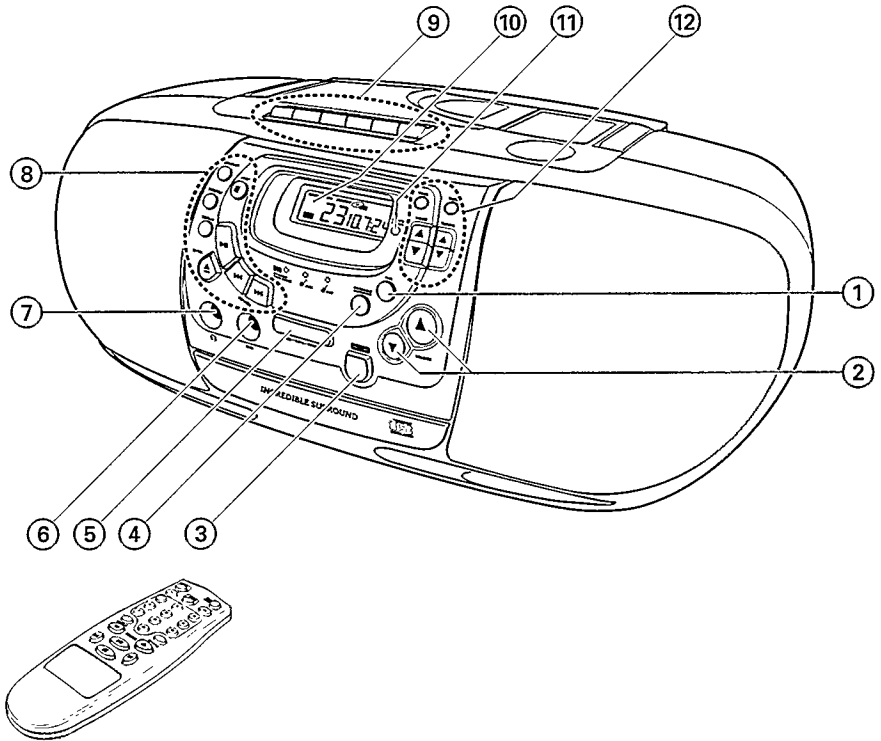

CAUTION: Use of controls or adjustments or performance of procedures other than those herein may result in hazardous radiation exposure.

The set complies with the FCC-Rules, Part 15 and with 21 CFR 1040.10. Operation is subject to the following two conditions:

- 1. This device may not cause harmful interference, and*
- 2. This device must accept any interference received, including interference that may cause undesired operation.*

BASIC FUNCTIONS

- ① DSC.....**DIGITAL SOUND CONTROL**
to enhance the type of music you are listening to
DBB-JAZZ-POP
 - ② VOLUME ▼ ▲to adjust the volume level
 - ③ ON-OFF.....to turn the set on and off
 - ④ INCREDIBLE SURROUND
to create a surround sound effect
 - ⑤ CD-TAPE-TUNER ...to select the sound source
 - ⑥ MIC3.5 mm microphone socket
 - ⑦3.5 mm headphone socket
- Note: Connecting the headphones will disconnect the speakers.*

⑧ CD PLAYER

- OPEN ▲to open/close the CD tray
- ▶||to start and to interrupt CD play
- STOP ■to stop CD play and to erase a program
- SEARCH ◀▶to skip and to search forward and backward
- PROGRAMto program track numbers and to review the program
- SHUFFLEto play tracks in random order
- REPEATto repeat one track or the entire CD or program

⑨ CASSETTE RECORDER

- RECORD ●to start recording
- PLAY ▶to start playback
- SEARCH ◀◀to rewind the tape
- SEARCH ▶▶to fast forward the tape
- STOP-OPEN ■ ▲to stop the tape and to open the cassette compartment
- PAUSE ||to interrupt recording or playback

- ⑩ DisplayWindow for showing different playing modes
- ⑪ REMOTE SENSOR...sensor for the infrared remote control

⑫ TUNER

- PROG.....to program preset stations
- TUNING ▲ ▼to tune to radio stations
- BAND.....to select the wave band
- PRESET ▲ ▼to select a preset station

REMOTE CONTROL

- CDto select CD functions
- TRAY OPEN.....to open/close the CD tray
- PRESET ▲ ▼to select a radio preset station
- TUNERto select tuner functions
- Digits 0-9CD: to enter a track number
TUNER: to enter a preset station
- SHUFFLEto play a CD in random order
- LONG PLAY.....to repeat one track or the entire CD or program
- VOLUME ▼ ▲to decrease or increase the volume level
- ▶||to start and to interrupt CD play
- ◀▶to select the beginning of the current/previous or a subsequent track
-to stop CD play

*Notes: – Always select the desired sound source first and then press the required function key.
– Numbers consisting of two figures must be keyed in within 2 seconds.*

POWER SUPPLY

English

Batteries

For the set (optional):

Open the battery compartment of the set and insert six batteries, type **R20**, **UM1** or **D-cells** (preferably alkaline).

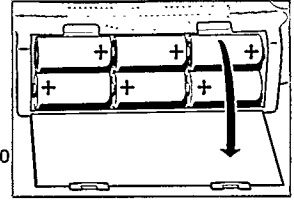

For the remote control (supplied):

Open the battery compartment of the remote control and insert two batteries, type **R03**, **UM4** or **AAA-cells** (preferably alkaline).

Remove the batteries if they are dead or if the set will not be used for a long time.

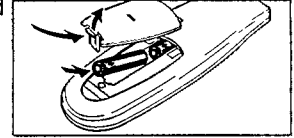

Batteries contain chemical substances, therefore they should be disposed of properly.

AC power

- 1 Check whether the voltage shown on the type plate corresponds to your local voltage. If it does not, consult your dealer or service organization. **The type plate is located on the base of the set.**

If the set is equipped with a VOLTAGE selector (⊗), set this selector to the local voltage.

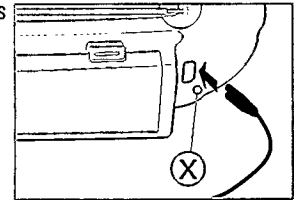

- 2 Connect the power cable to the AC MAINS inlet and the wall socket. This switches on the power supply. **The cable is inside the battery compartment.**

The battery supply will be switched off when the set is connected to a power supply. To change over to battery supply, remove the plug from the unit's AC MAINS socket.

To disconnect the set from the completely, remove the power plug from the wall socket.

To avoid overheating of the set a safety circuit has been built in. Therefore your set may switch off under extreme conditions. If this happens, release the ON-OFF button and let the set cool down before reusing it.

BASIC FUNCTIONS

English

Switching on and off/standby

Push the ON-OFF button.

- The display lights up. If the set is using batteries the display will not be back-lit.

The set is switched off when the ON-OFF button is released.

In order to switch off the power supply, remove the power plug.

Note: If you are using batteries, always be sure to switch the set off after use. This will avoid unnecessary power consumption.

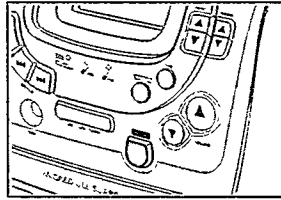

Adjusting volume and sound

Adjust the volume using the controls VOLUME ▼▲.

- Display indication: Volume level from 0 to 32.

Adjust the sound to suit your taste by pressing the button DSC several times (DBB is **D**ynamic **B**ass **B**oost).

- A light indicates either DBB-JAZZ-POP.

Create a surround sound effect by pressing INCREDIBLE SURROUND.

- The INCREDIBLE SURROUND button lights up.

Note: The effect of INCREDIBLE SURROUND may vary with different types of music.

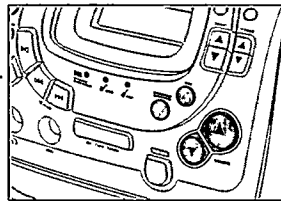

Do not cover any vents and leave sufficient room around the unit for ventilation.

TUNER

English

Tuning to radio stations

- 1 Select the tuner by pressing the CD-TAPE-TUNER button until **TUNER** appears on the display.
- 2 Select the wave band by using the BAND selector.
→ Display indication: the selected waveband.
- 3 Press TUNING ▼ or ▲ for approximately one second and then release the button.
→ The radio automatically tunes to a station with sufficient strength. Display indication during automatic tuning: *Sr ch*
- 4 Repeat this procedure until you find a station you desire.

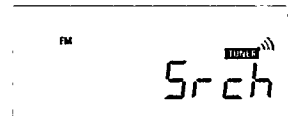
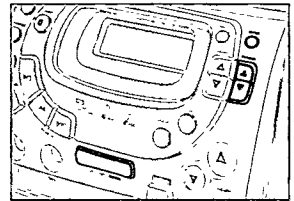

To tune to a weak station briefly press TUNING ▼ or ▲ as often as necessary for optimum reception, or until the correct frequency is indicated in the display.

Improving RADIO reception

For **FM** pull out the external antenna. To improve the signal, incline and turn the antenna. Reduce its length if the signal is too strong (very close to a transmitter).

For **AM**, direct the internal antenna by turning the whole set. The external antenna is not needed.

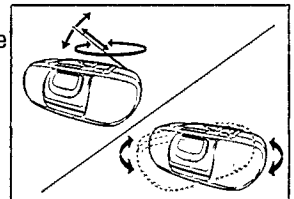

Programming radio stations (29 preset stations)

You can store up to 29 radio stations in the memory. When tuning to a preset station, the preset number (1 to 29) is indicated in the display.

- 1 Select the tuner by pressing the CD-TAPE-TUNER button until **TUNER** appears on the display.
- 2 Tune to a desired station with TUNING ▼ or ▲, as described earlier.
 - If the frequency is already stored in the memory, the preset number will be displayed.
- 3 Press PROG to enter the programming mode.
 - During programming, PROGRAM flashes on the display.
- 4 Press PRESET ▼ or ▲ to assign a number from 1 to 29 to the preset station.
- 5 Press PROG to confirm the setting.

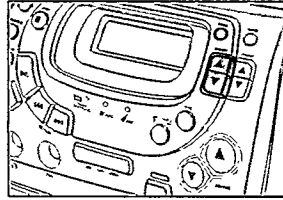

Tuning to preset stations

Press PRESET ▼ or ▲ until the desired preset number appears on the display.

Environmental information

All redundant packing material has been omitted. We have tried to make the packaging easy to separate into three mono materials: cardboard (box), polystyrene foam (buffer) and polyethylene (bags, protective foam sheet).

Your set consists of material which can be recycled if disassembled by a specialized company. Please observe the local regulations regarding the disposal of packing materials, expanded batteries and old equipment.

CD PLAYER

English

Playing a CD

This CD player can play all kinds of Audio Discs such as CD-Recordables and CD-Rewriteables. Do not try to play a CD-ROM, CD-I, CDV or computer CD.

1 Select the CD player by pressing the CD-TAPE-TUNER button until  appears on the display.

2 Open the tray by pressing the OPEN  button.

3 Insert an audio CD (printed side up) and close the tray by pushing it gently or pressing the OPEN  button again.

→ The CD player starts and scans the contents list of the CD.
Display indication: the total number of tracks and the total playing time. After that the CD player stops.

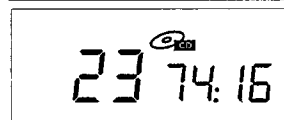
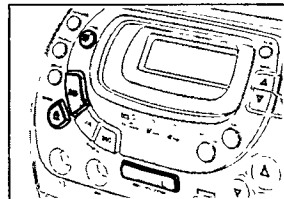

4 Press the  button to start CD play.

→ Display indication: the current track number and the elapsed time of the current track.

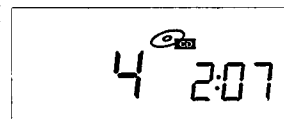

5 Press the STOP  button to stop CD play.

→ Display indication: the total number of tracks and the total playing time.

You can interrupt CD play by pressing . Continue CD play by pressing the button again.

→ Display indication: the time where playback was stopped flashes.

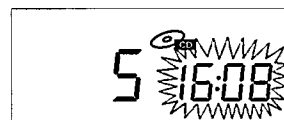

Notes: CD play will also stop if:

- you open the tray;
- you push the ON-OFF button or
- the end of the CD is reached.

If you make a mistake operating the CD player, or the CD player cannot read the CD, the display indicates *Error* (see TROUBLESHOOTING).

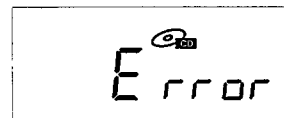

Search backward ◀◀ and ▶▶ forward

Selecting another track

Briefly press the SEARCH ◀◀ or ▶▶ button once/several times to skip to the beginning of the current/previous or subsequent track(s).

During play:

CD play continues automatically with the selected track.

From stop position:

Press ▶|| to start CD play.

→ Display indication: the selected track number.

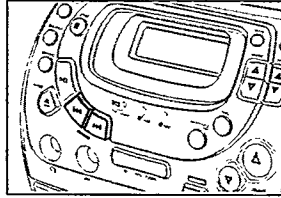

Searching for a passage during CD play

1 Hold down the SEARCH ◀◀ or ▶▶ button to find a particular passage in a forward or backward direction.

→ CD play continues at a low volume.

2 Release the button when you have reached the desired passage.

Note: In the SHUFFLE and REPEAT modes and when playing a program, searching is only possible within a particular track.

Different playing modes: SHUFFLE / REPEAT

SHUFFLE – playing in random order

1 Press SHUFFLE before or during CD play.

→ All the tracks of the CD (or program if available) will now be played in random order.

2 To return to normal CD play, press SHUFFLE again.

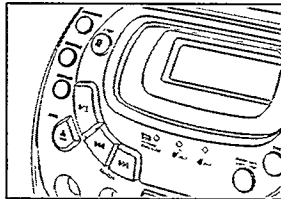

REPEAT – Repeating the entire CD or one track of the CD

1 Before or during CD play, repeatedly press REPEAT to cause the display to show the different repeating modes.

→ REPEAT: the current track is played repeatedly.

→ REPEAT ALL: the entire CD or program is played repeatedly.

2 To return to normal CD play press REPEAT until the display indication disappears.

Note: You can activate the different playing modes at the same time, e. g. you can repeatedly play the entire CD or program in random order (SHUFFLE REPEAT ALL).

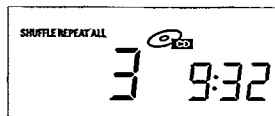

CD PLAYER

English

Programming track numbers

You can select a number of tracks and store these in the memory in the desired sequence. You can store any track more than once. At most, 20 tracks can be stored in the memory.

- 1 Select the desired track with SEARCH ◀◀ or ▶▶.
- 2 As soon as the desired track is displayed, press the PROGRAM button to store the track in the memory.
 - PROGRAM appears in the display. The number of the stored track, *P r*, and the total number of stored tracks is shown.
- 3 Select and store all desired tracks in this way.

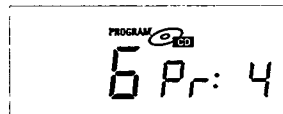
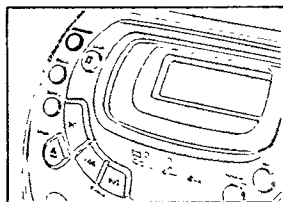

You can review your settings by pressing the PROGRAM button for more than 2 seconds.

- The display shows all stored track numbers in sequence.

Notes: – If you try to store more than 20 tracks, the display shows FULL.

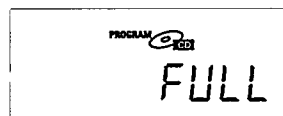

– If you press PROGRAM and there is no track selected the display shows SELECT.

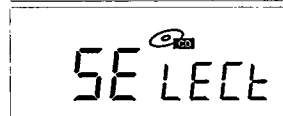

Playing the program

If you have selected the tracks in the stop position, press ▶II.

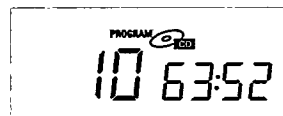

If you have selected the tracks during CD play, first press STOP ■ and then press ▶II.

Erasing the program from the stop position

From the stop position, press STOP ■.

- CLEAR lights up briefly, PROGRAM disappears and your program is erased.

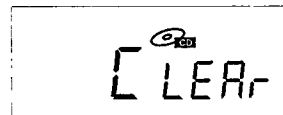

Notes: The program will also be erased if you

- interrupt the power supply,*
- open the tray, or*
- press the ON-OFF button.*

CASSETTE RECORDER

Playing a cassette

- 1 Select the tape by pressing the CD-TAPE-TUNER button until **TAPE** appears on the display.
- 2 Press STOP-OPEN ■▲ to open the cassette compartment.
- 3 Insert a recorded cassette with the open side facing the front.
- 4 Close the cassette compartment by pushing it down.
- 5 Press PLAY ► to start playback.
- 6 By pressing ◀◀ or ▶▶ rewinding or fast forwarding of the tape is possible.
- 7 To stop the tape press STOP-OPEN ■▲.

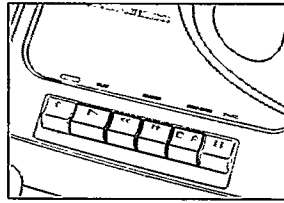

English

*Notes: – The keys are automatically released at the end of the tape.
– If PLAY ► or RECORD ● are depressed, you can not switch to another sound source.*

General information on recording

Recording is permissible insofar as copyright or other rights of third parties are not infringed upon.

For recording on this set you should use a cassette of the type NORMAL (IEC type I). This deck is not suitable for recording on cassettes of the type CHROME (IEC type II) or METAL (IEC type IV).

The recording level is set automatically. The controls VOLUME, DSC and INCREDIBLE SURROUND do not affect the recording.

At the very beginning and end of the tape, no recording will take place in the 7 seconds during which the leader tape passes the recorder heads.

Protecting tapes from accidental erasure

Keep the cassette side to be protected in front of you and snap off the left tab. Now, recording on this side is no longer possible.

To record again on this side of the cassette, cover the hole with a piece of cellophane tape.

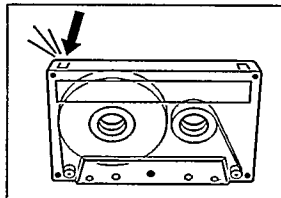

CASSETTE RECORDER

English

Recording from the CD player – CD synchro start

- 1 Select the CD by pressing the CD-TAPE-TUNER button until **CD** appears on the display.
- 2 Insert a CD and, if desired, program track numbers.
- 3 Press STOP-OPEN ■ ▲ to open the cassette compartment.
- 4 Insert a blank cassette with the open side facing the front.
- 5 Close the cassette compartment by pushing it down.
- 6 Press RECORD ● to start recording.
→ Playing of the CD or program starts automatically. It is not necessary to start the CD player separately.
- 7 For brief interruptions, press PAUSE II. To resume recording, press the PAUSE II key again.
- 8 To stop recording, press STOP-OPEN ■ ▲.

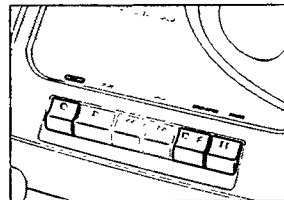

Notes: the recording can be started from different positions:
– if the CD player is in the Pause mode, recording will start from this very position (use SEARCH ◀◀ or ▶▶);
– if the CD player is in the stop mode, recording will start from the beginning of the CD or program.

Recording from the radio or with the microphone

- 1 (Selecting and preparing the source)
RADIO: Select the radio by pressing the CD-TAPE-TUNER button until **TUNER** appears on the display.
MICROPHONE: Select the tape by pressing the CD-TAPE-TUNER button until **TAPE** appears on the display. Connect a microphone with a 3.5 mm plug to the MIC socket and set the VOLUME control to zero (monitoring during microphone recording is not possible).
- 2 Press STOP-OPEN ■ ▲ to open the cassette compartment.
- 3 Insert an unprotected blank cassette with the open side facing front.
- 4 Press RECORD ● to start recording.
- 5 For brief interruptions press PAUSE II. To resume recording press the PAUSE II key again.
- 6 To stop recording, press STOP-OPEN ■ ▲.

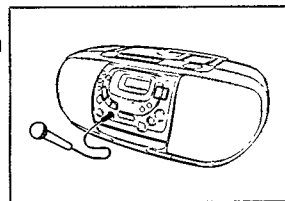

Note: When recording from the radio or a CD, you can connect a microphone and mix the sounds. Otherwise, be sure there is no microphone connected that could disturb your recording.

GENERAL INFORMATION

English

General maintenance

Do not expose the set, batteries, CDs or tapes to humidity, rain, sand or excessive heat (caused by heating equipment or direct sunlight).

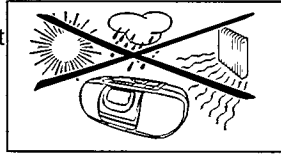

The mechanical parts of the set contain self-lubricating bearings and must not be oiled or lubricated!

You can clean the set with a soft, slightly dampened chamois cloth. Do not use any cleaning agents as they may have a corrosive effect.



Tape deck maintenance

To ensure proper recording and playback quality, clean parts (A)(B)(C) after approximately 50 hours of operation. Use a cotton swab slightly moistened with alcohol or a special head-cleaner fluid.

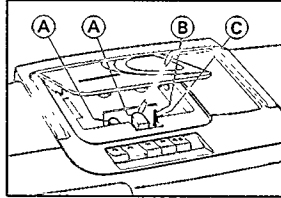

Press PLAY ► and clean the rubber pressure rollers (C).

Press PAUSE II and clean the capstans (B) and the heads (A).

Note: Cleaning of the heads (A) can also be done by playing a cleaning tape once.

CD player and CD handling

The lens may cloud over when the set is suddenly moved from cold to warm surroundings. Playing a CD is not possible at such times. Leave the CD player in a warm environment until the moisture evaporates.

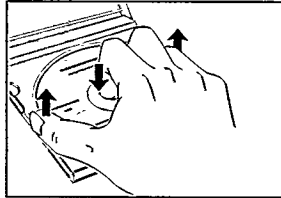

To take the CD out of its box easily, press the center spindle while lifting the CD.

Always pick up the CD by the edge and put it back in its box after use.

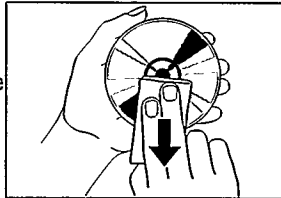

To clean the CD, wipe it in a straight line from the center toward the edge using a soft, lint-free cloth. A cleaning agent may damage the disc!

Never write on a CD or attach a sticker to it.

TROUBLESHOOTING

English

WARNING

Under no circumstances should you try to repair the set yourself, as this will invalidate the warranty.

If a fault occurs, first check the points listed below before taking the set for repair.

If you are unable to remedy a problem by following these hints, consult your dealer or service center.

PROBLEM	POSSIBLE CAUSE	SOLUTION
No sound / no power	VOLUME is not adjusted	Adjust the VOLUME
	Headphones are connected	Disconnect headphones
	Powercable is not securely connected	Connect the cable properly
	Batteries are dead	Replace batteries
	Batteries are incorrectly inserted	Insert the batteries correctly
No reaction to operation of any keys	Changing over from AC power to battery supply without removing the plug	Remove the plug from the AC MAINS inlet
	Electrostatic discharge	Disconnect the set from power supply reconnect it after a few seconds
Poor radio reception	Weak radio signal	Aim the antenna for optimum reception:
	Interference caused by the vicinity of electrical equipment like TVs, video recorders, computers, engines, etc.	Keep the radio away from electrical equipment
no d 15C indication	CD-RW (CD-R) is not properly recorded for the use on a standard CD player.	Use FINALIZE on the CD recorder to complete the recording.
no d 15C or Error indication	The CD is badly scratched or dirty	Replace or clean the CD, see maintenance
	No CD is inserted	Insert a CD
	The CD is inserted upside down	Insert a CD with the label facing up
The CD skips tracks	The laser lens is steamed up	Wait until the lens has cleared
	The CD is damaged or dirty	Replace or clean the CD
Poor cassette sound quality	SHUFFLE or PROGRAM is active	Switch off shuffle or program play
	Dust and dirt on the heads, capstan or pressure roller	Clean the heads, capstans and pressure roller, see MAINTENANCE
Recording does not work	Use of unsuitable cassette types (METAL or CHROME)	Only use NORMAL cassettes for recording
	Cassette tab(s) may be snapped off	Put a piece of cellophane tape over the hole
Remote control does not function properly	Batteries are incorrectly inserted	Insert the batteries correctly
	Batteries are dead	Replace batteries
	Distance to the set is too far	Reduce the distance

LIMITED WARRANTY

PHILIPS MAGNAVOX PORTABLE COMPACT DISC

One Year Free Exchange

This product must be carried in for an exchange.

WHO IS COVERED?

You must have proof of purchase to exchange the product. A sales receipt or other document showing that you purchased the product is considered proof of purchase. Attach it to this owner's manual and keep both nearby.

WHAT IS COVERED?

Warranty coverage begins the day you buy your product. For one year thereafter, a defective or inoperative product will be replaced with a new, renewed or comparable product at no charge to you. A replacement product is covered only for the original warranty period. When the warranty on the original product expires, the warranty on the replacement product also expires.

WHAT IS EXCLUDED?

Your warranty does not cover:

- labor charges for installation or setup of the product, adjustment of customer controls on the product, and installation or repair of antenna systems outside of the product.
- product repair and/or part replacement because of misuse, accident, unauthorized repair or other cause not within the control of Philips Consumer Electronics Company.
- reception problems caused by signal conditions or cable or antenna systems outside the unit.
- a product that requires modification or adaptation to enable it to operate in any country other than the country for which it was designed, manufactured, approved and/or authorized, or repair of products damaged by these modifications.
- incidental or consequential damages resulting from the product. (Some states do not allow the exclusion of incidental or consequential damages, so the above exclusion may not apply to you. This includes, but is not limited to, prerecorded material, whether copyrighted or not copyrighted.)
- a product that is used for commercial or institutional purposes.

WHERE IS EXCHANGE AVAILABLE?

You may exchange the product in all countries where the product is officially distributed by Philips Consumer Electronics Company. In countries where Philips Consumer Electronics Company does not distribute the product, the local Philips service organization will attempt to provide a replacement product (although there may be a delay if the appropriate product is not readily available).

BEFORE REQUESTING EXCHANGE...

Please check your owner's manual before requesting an exchange. Adjustments of the controls discussed there may save you a trip.

EXCHANGING A PRODUCT IN U.S.A., PUERTO RICO OR U.S. VIRGIN ISLANDS...

Contact your dealer to arrange an exchange. Or, ship the product, insured and freight prepaid, and with proof of purchase enclosed, to the address listed below.

Small Product Service Center
Philips Service Company

907 Snapps Ferry Road, Plant 2, Building 6
Greeneville, TN 37743

(In U.S.A., Puerto Rico and U.S. Virgin Islands, all implied warranties, including implied warranties of merchantability and fitness for a particular purpose, are limited in duration to the duration of this express warranty. But, because some states do not allow limitations on how long an implied warranty may last, this limitation may not apply to you.)

EXCHANGING A PRODUCT IN CANADA...

Please contact Philips at:

1-800-661-6162 (French Speaking)

1-800-363-7278 (English Speaking)

(In Canada, this warranty is given in lieu of all other warranties. No other warranties are expressed or implied, including any implied warranties of merchantability or fitness for a particular purpose. Philips is not liable under any circumstances for any direct, indirect, special, incidental or consequential damages, howsoever incurred, even if notified of the possibility of such damages.)

TO GET OUT-OF-WARRANTY EXCHANGE...

In U.S.A., Puerto Rico or U.S. Virgin Islands, contact Philips Service Company at (800) 851-8885 to obtain the cost of out-of-warranty exchange. Then carefully pack the product and ship it to the Small Product Service Center (address listed above). In Canada, call the phone number listed above under "Exchanging a Product a Canada" to obtain the cost of out-of-warranty exchange.

REMEMBER...

Please record the model and serial numbers found on the product below. Also, please fill out and mail your warranty registration card promptly. It will be easier for us to notify you if necessary.

MODEL # _____

SERIAL # _____

This warranty gives you specific legal rights. You may have other rights which vary from state/province to state/province.

Philips Service Company, P.O. Box 555, Jefferson City, Tennessee 37760, (423) 475-8869

EL4967E003 / MAC 4108 / 1-97



English

Français

Español

PHILIPS CONSUMER ELECTRONICS COMPANY

A Division of Philips Electronics North America Corporation
Knoxville, Tennessee 37914-1810, U.S.A.

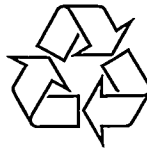

**CLASS 1
LASER PRODUCT**