

PHILIPS

AZ 1209 CD Radio Cassette Recorder

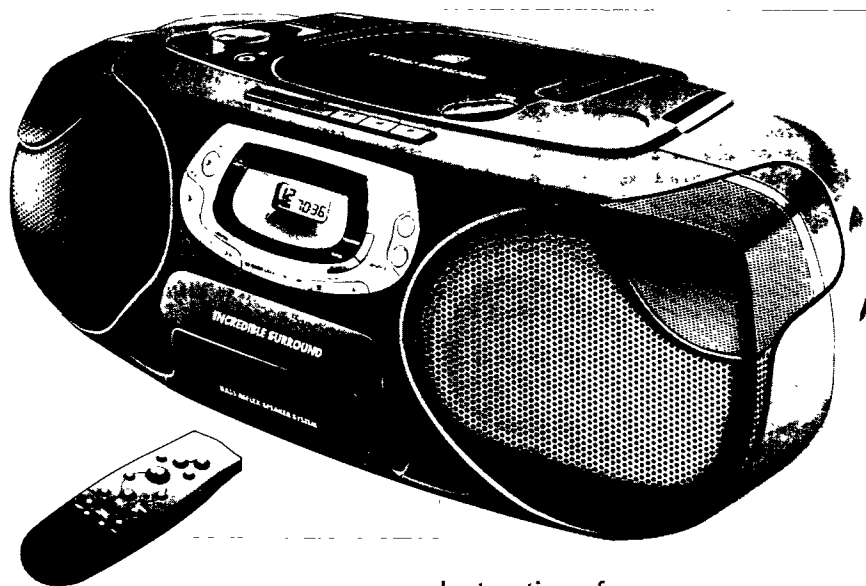

Instructions for use
Mode d'emploi
Instrucciones de manejo
Bedienungsanleitung
Gebruiksaanwijzing
Istruzioni per l'uso
Brugsanvisning
Bruksanvisning
Käyttöohje
Manual de utilização
Οδηγίες χρήσεως



PHILIPS

Important notes for users in the U.K.

Mains plug

This apparatus is fitted with an approved 13 Amp plug. To change a fuse in this type of plug proceed as follows:

- 1 Remove fuse cover and fuse.
- 2 Fix new fuse which should be a BS1362 5 Amp, A S.T.A. or BSI approved type.
- 3 Refit the fuse cover.

If the fitted plug is not suitable for your socket outlets, it should be cut off and an appropriate plug fitted in its place. If the mains plug contains a fuse, this should have a value of 5 Amp. If a plug without a fuse is used, the fuse at the distribution board should not be greater than 5 Amp.

Note: The severed plug must be disposed of to avoid a possible shock hazard should it be inserted into a 13 Amp socket elsewhere

How to connect a plug

The wires in the mains lead are coloured with the following code: blue = neutral (N), brown = live (L). As these colours may not correspond with the colour markings identifying the terminals in your plug, proceed as follows:

- Connect the blue wire to the terminal marked N or coloured black
- Connect the brown wire to the terminal marked L or coloured red.
- Do not connect either wire to the earth terminal in the plug, marked E (or \oplus) or coloured green (or green and yellow).

Before replacing the plug cover, make certain that the cord grip is clamped over the sheath of the lead - not simply over the two wires.

Copyright in the U.K.

Recording and playback of material may require consent. See Copyright Act 1956 and The Performer's Protection Acts 1958 to 1972.

Norge

Typeskilt finnes på apparatens underside.

Observer: Nettbryteren er sekundært innkopleet. Den innebygde nettdelen er derfor ikke frakopleet nettet så lenge apparatet er tilsluttet nettkontaktten.

For å redusere faren for brann eller elektrisk støt, skal apparatet ikke utsettes for regn eller fuktighet.

Deutschland

Hiermit wird bescheinigt, daß dieses Gerät in Übereinstimmung mit den Bestimmungen der Amtsblattverfugung 1046/1984 funktentstört ist.

Der Deutschen Bundespost wurde das Inverkehrbringen dieses Gerätes angezeigt und die Berechtigung zur Überprüfung der Serie auf Einhaltung der Bestimmungen eingeräumt

Italia

DICHIARAZIONE DI CONFORMITA'

Si dichiara che l'apparecchio Lettore CD/Radio-registratore mod. AZ1209 Philips risponde alle prescrizioni dell'art. 2 comma 1 del D. M. 28 Agosto 1995 n. 548.

Fatto a Eindhoven, il 22/07/1997

Philips Sound & Vision
Philips, Glaslaan 2, SFF 10
5616 JB Eindhoven, The Netherlands

English	Controls	4-5	CD player	9-11	English
	Power supply	6	Cassette recorder	12-13	
	Basic functions	7	General information	14	
	Radio	8	Troubleshooting	15	
Français	Comandes	16-17	Lecteur de CD	21-23	Français
	Alimentation	18	Platine cassette	24-25	
	Fonctions de base	19	Informations général	26	
	Radio	20	Recherche de pannes	27	
Español	Controles	28-29	Reproductor CD	33-35	Español
	Fuente de alimentación	30	Grabadora	36-37	
	Funciones básicas	31	Información general	38	
	Radio	32	Localización de averías	39	
Deutsch	Bedienungselemente	40-41	CD-Spieler	45-47	Deutsch
	Stromversorgung	42	Kassetterecorder	48-49	
	Grundfunktionen	43	Allgemeine Informationen	59	
	Radio	44	Fehlerbehebung	51	
Nederlands	Bedieningstoetsen	52-53	Cd-speler	57-59	Nederlands
	Voeding	54	Cassetterecorder	60-61	
	Basisfuncties	55	Algemene informatie	62	
	Radio	56	Problemen oplossen	63	
Italiano	Comandi	64-65	Lettore CD	69-71	Italiano
	Alimentazione	66	Registratore	72-73	
	Funzioni principali	67	Informazioni generale	74	
	Radio	68	Ricerca guasti	75	
Svenska	Kontroller	76-77	CD-spelare	81-83	Svenska
	Strömförsörjning	78	Kassettspelare	84-85	
	Basfunktioner	79	Allmän information	86	
	Radio	80	Felsökning	87	
Dansk	Betjeningsorganer	88-89	CD-afspiller	93-95	Dansk
	Strømforsyning	90	Kassettebåndoptager	96-97	
	Grundfunktioner	91	Generel information	98	
	Radio	92	Fejlfinding	99	
Suomi	Saadot	100-101	CD-soition	105-107	Suomi
	Virtalähde	102	Kasettinauhuri	108-109	
	Perustoiminnot	103	Yleistietoja	110	
	Radio	104	Vianetsintä	111	
Português	Comandos	112-113	Leitor CD	117-119	Português
	Alimentação	114	Gravador de cassetes	120-121	
	Funções básicas	115	Informações gerais	122	
	Radio	116	Localização der avarias	123	
Ελληνικά	Οδηγίες χρήσης	124-125	Φορητό CD	129-131	Ελληνικά
	Τροφοδοσία	126	Κασετόφωνο	132-133	
	Βασικές λειτουργίες	127	Γενικές πληροφορίες	134	
	Ραδιό	128	Ανεύρεση προβλημάτων	135	

CONTROLS

English

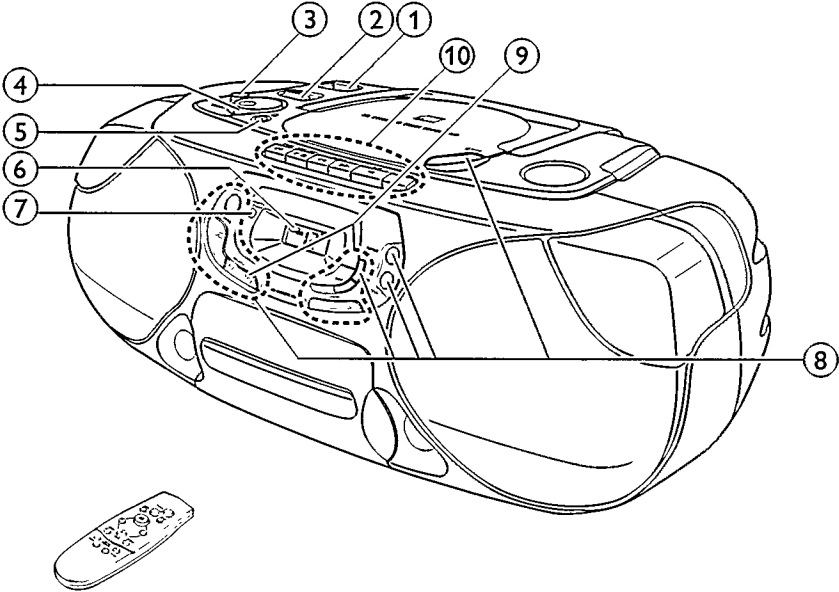

BASIC FUNCTIONS

- ① POWER:
CD, TUNER, TAPE...selects the sound source
- ② INCREDIBLE
SURROUNDcreates a phenomenal
stereo effect
- ③ DBB.....enhances the bass
- ④ VOLUME ▽ ▲.....adjusts the volume level
- ⑤ .....3.5mm headphone socket

Note: Connecting the headphones will switch off the speakers.

- ⑥ Display
- ⑦ REMOTE SENSOR...sensor for the infrared
remote control



⑧ CD PLAYER

- △ OPENopens the CD
compartment
- STOP □.....stops CD play and erases
the program
- PLAY-PAUSE ▷◁.....starts and interrupts CD
play
- SEARCH ◀◀ ▶▶.....skips and searches
forward and backward
- PROGRAMprograms track numbers
and reviews the program
- SHUFFLEplays CD tracks in random
order
- REPEATrepeats a track, the entire
CD, or the program

⑨ RADIO

- SEARCH ◀◀ ▶▶.....tunes to radio stations
- BAND.....selects the wave band
- PROGRAMprograms radio preset
stations
- PRESET ▲ ▽.....selects a radio preset
station

⑩ CASSETTE RECORDER

- PAUSE .....interrupts recording or
playback
- STOP-OPEN .....stops the tape and opens
the cassette compartment
- SEARCH ▶▶rewinds the tape
- SEARCH ◀◀fast forwards the tape
- PLAY ◀.....starts playback
- RECORD ○starts recording

REMOTE CONTROL

- VOLUME ▼ ▲.....decreases or increases the
volume level
- SHUFFLEplays CD tracks in random
order
- REPEATrepeats a track, the entire
CD or the program
- ▶||starts and interrupts CD
play
- ◀▶.....selects the beginning of
the current, a previous or a
subsequent track of a CD
-stops CD play and erases
the program
- SEARCH ◀◀ ▶▶.....searches backward/forward
in a CD track
- PRESET ▲ ▼.....selects a radio preset
station
- TUNING ◀◀ ▶▶.....tunes to radio stations

POWER SUPPLY

English

Batteries

For the set (optional)

Open the battery compartment of the set and insert 6 batteries, type **R20**, **UM-1** or **D**-cells (preferably alkaline).

For the remote control (supplied)

Open the battery compartment of the remote control and insert 2 batteries, type **R03**, **UM-4** or **AAA**-cells (preferably alkaline).

Remove batteries if they are flat or the set is not going to be used for a longer period of time.

Batteries contain chemical substances, so they should be disposed of properly.

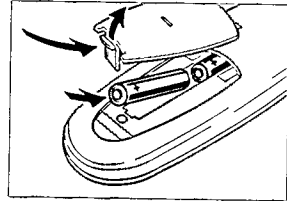
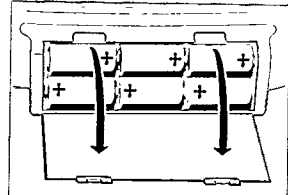

Mains

- 1 Check whether the mains voltage as shown on the type plate corresponds to your local mains voltage. If it does not, consult your dealer or service organisation. **The type plate is located on the bottom side of the set.**
- 2 If the set is equipped with a VOLTAGE selector (⊗), set this selector to the local mains voltage.
- 3 Connect the mains cable to the AC MAINS inlet and the wall socket. **This switches on the mains supply. The mains cable is inside the battery compartment.**

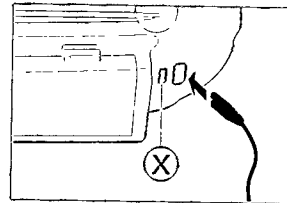

The battery supply will be switched off when the set is connected to the mains. To change over to battery supply, pull out the plug from the unit's AC MAINS socket.

To disconnect the set from the mains completely, remove the mains plug from the wall socket.

For users in the U.K.: please follow the instructions on page 2.

Environmental information

All redundant packing material has been omitted. We have done our utmost to make the packaging easily separable into three mono materials: cardboard (box), polystyrene foam (buffer) and polyethylene (bags, protective foam sheet).

Your set consists of materials which can be recycled if disassembled by a specialized company. Please observe the local regulations regarding the disposal of packing materials, exhausted batteries and old equipment.

BASIC FUNCTIONS

English

Switching on and off

Set the **POWER** slider to the desired sound source: CD, TUNER, or TAPE.

The set is switched off when the **POWER** slider is in position OFF/TAPE and the keys of the tape deck are released.

Note: If you run the set on batteries, always be sure to switch the set off after use. This will avoid unnecessary power consumption.

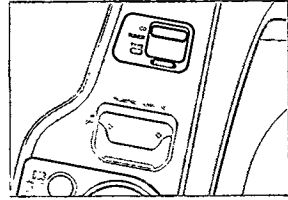

Adjusting volume and sound

Adjust the volume using the **VOLUME** ∇ Δ control.
→ Display indication: Volume level from 0 to 32.

Increase and decrease the bass level by pressing **DBB**.

Switch the surround sound effect on and off by pressing **INCREDIBLE SURROUND**.

The bass level can also be emphasised if you place the set against a wall or shelf. Do not cover any vents and leave sufficient room around the unit for ventilation.

Note: The effect of INCREDIBLE SURROUND may vary with different types of music.

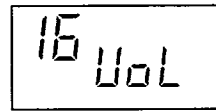
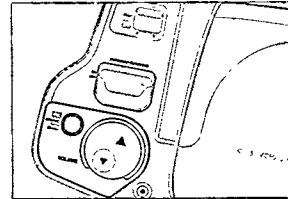

Improving radio reception

For **FM** stations, pull out the telescopic antenna. To improve the signal, incline and turn the antenna. Reduce its length if the signal is too strong (very close to a transmitter).

For **MW** and **LW** stations, direct the built-in antenna by turning the whole set. The telescopic antenna is not needed.

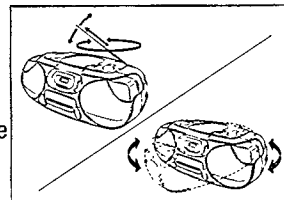

RADIO

English

Tuning to radio stations

- 1 Set the POWER slider to TUNER.
- 2 Select the wave band by using the BAND selector.
→ Display indication: the selected waveband.
- 3 Press SEARCH ◀◀ or ▶▶ for approx. 1 second and then release the button.
→ The radio automatically tunes to a station with sufficient strength. Display indication during automatic tuning: *Srch*.
- 4 Repeat this procedure until you find a station you desire.

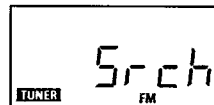
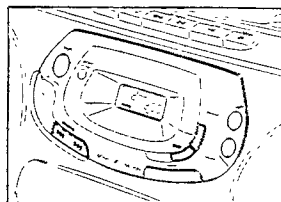

To tune to a weak transmitter briefly press SEARCH ◀◀ or ▶▶ as often as necessary for optimum reception, or until the correct frequency is indicated in the display.

Programming radio stations (29 preset stations)

You can store up to 29 radio stations in the memory. When tuning to a preset station, the preset number (1 to 29) is indicated in the display.

- 1 Set the POWER slider to TUNER.
- 2 Press PROGRAM to enter the programming mode.
→ During programming, **PROGRAM** flashes on the display.
- 3 Tune to a desired station with SEARCH ◀◀ or ▶▶, as described earlier (see "Tuning to radio stations").
→ If the frequency is already stored in the memory, the preset number will be displayed.
- 4 Press PRESET ▽ or ▲ to allocate a number from 1 to 29 to the preset station.
- 5 Press PROGRAM to confirm the setting.

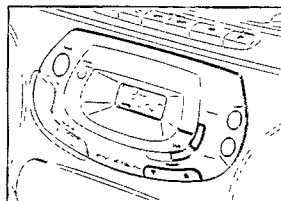

Tuning to preset stations

Press PRESET ▽ or ▲ until the desired preset number appears on the display.



Playing a CD

- 1 Set the POWER slider to CD.
- 2 Press \triangle OPEN to open the CD compartment.
- 3 Insert an audio CD (printed side up) and close the CD compartment.
 - The CD player starts and scans the contents list of the CD. Then, the CD player stops. Display indication: the total number of tracks and the total playing time of the CD.
- 4 Press the PLAY-PAUSE $\triangleright \parallel$ button to start CD play.
 - Display indication: the current track number.
- 5 Press the STOP \square button to stop CD play.
 - Display indication: the total number of tracks.

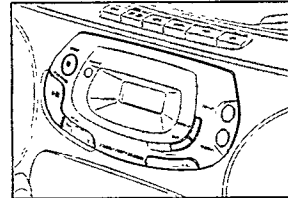
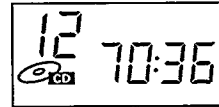
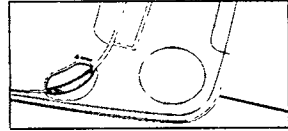

You can interrupt CD play by pressing PLAY-PAUSE $\triangleright \parallel$. Continue CD play by pressing the button again.

- Display indication: the time of the actual position flashes.

Note: CD play will also stop if:

- you open the CD compartment,
- the end of the CD is reached, or
- you move the POWER slider to TUNER or TAPE.

If you make a mistake when operating the CD player, or the CD player cannot read the CD, the display shows *cd Err.* (See chapter "TROUBLESHOOTING".)

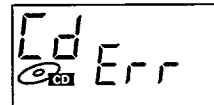

If you press PLAY-PAUSE $\triangleright \parallel$ and there is no CD inserted the display shows *no disc*.

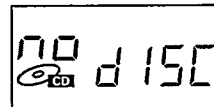

CD PLAYER

English

Different playing modes: SHUFFLE / REPEAT

SHUFFLE – Playing in random order

- 1 Press SHUFFLE before or during CD play.
 - All the tracks of the CD (or program if available) will now be played in random order.
- 2 Press SHUFFLE again to return to normal CD play.

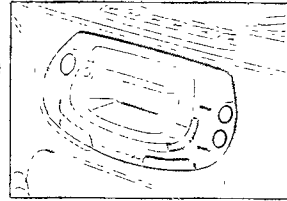

REPEAT – Repeating the entire CD or one track of the CD

- 1 Before or during CD play, press REPEAT repeatedly to cause the display to show the different repeating modes.
 - REPEAT: the current track is played repeatedly.
 - REPEAT ALL: the entire CD or program is played repeatedly.
- 2 Press REPEAT until the display indication disappears to return to normal CD play.

Note: You can activate the different playing modes at the same time, e. g. you can repeatedly play the entire CD or program in random order (SHUFFLE REPEAT ALL).

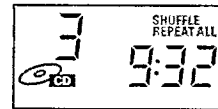

Search backward ◀◀ and forward ▶▶

Selecting another track

Briefly press the SEARCH ◀◀ or ▶▶ button once/several times to skip to the beginning of the current/previous or subsequent track(s).

During play:

CD play continues automatically with the selected track.

When CD playback is stopped:

Press PLAY-PAUSE ▷◁ to start CD play.

→ Display indication: the selected track number.

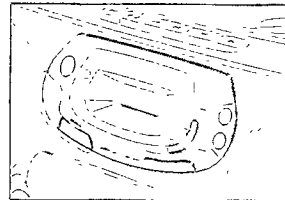

Searching for a passage during CD play

- 1 Hold down the SEARCH ◀◀ or ▶▶ button to find a particular passage in a forward or backward direction.
 - CD play continues at a low volume.
- 2 Release the button when you have reached the desired passage.

Note: In the SHUFFLE and REPEAT modes or when playing a program, searching is only possible within the particular track.

Programming track numbers

You can select a number of tracks and store these in the memory in the desired sequence. You can store any track more than once. A maximum of 20 tracks can be stored in the memory.

- 1 Select the desired track with SEARCH ◀◀ or ▶▶.
- 2 As soon as the number of the desired track is displayed, press the PROGRAM button to store the track in the memory.
 - PROGRAM appears in the display and the number of the stored track is shown. Then *prog* lights up briefly.
- 3 Select and store all desired tracks in this way.

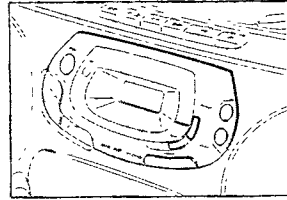

You can review your settings by pressing the PROGRAM button for more than 2 seconds.

- The display shows all stored track numbers in sequence.

If you try to store more than 20 tracks the display shows *FULL*.

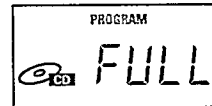

If you press PROGRAM and there is no track selected, the display shows *no SEL*.

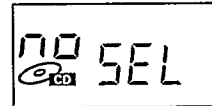

Playing the program

If you have selected the tracks in the stop position, press PLAY-PAUSE ▷◁.

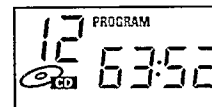

If you have selected the tracks during CD play, first press STOP □, then press PLAY-PAUSE ▷◁.

Erasing the program when CD playback is stopped

From the stop position, press STOP □.

- *no prog* lights up briefly, PROGRAM disappears and your program is erased.

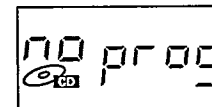

Note: The program will also be erased if you

- interrupt the power supply,
- open the CD compartment, or
- move the POWER slider to TUNER or TAPE.

CASSETTE RECORDER

English

Playing a cassette

- 1 Set the POWER slider to TAPE.
- 2 Press STOP-OPEN $\square \triangle$ to open the cassette compartment.
- 3 Insert a recorded cassette with the open side upwards and close the cassette compartment.
- 4 Press PLAY \triangleleft to start playback.
- 5 Press \gg or \ll to rewind or fast forward the tape.
- 6 To stop the tape press STOP-OPEN $\square \triangle$.

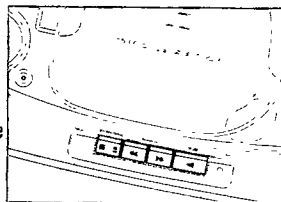

Note: The keys are released at the end of the tape.

General information on recording

Recording is permissible insofar as copyright or other rights of third parties are not infringed upon.

For recording on this set you should use a cassette of the type NORMAL (IEC type I). This deck is not suitable for recording on cassettes of the type CHROME (IEC type II) or METAL (IEC type IV).

The recording level is set automatically. The controls VOLUME, INCREDIBLE SURROUND and DBB do not affect the recording.

At the very beginning and end of the tape, no recording will take place in the 7 seconds during which the leader tape passes the recorder heads.

Protecting tapes from accidental erasure

Keep the cassette side to be protected in front of you and snap off the left tab. Now, recording on this side is no longer possible.

To record again on this side of the cassette, cover the aperture with a piece of adhesive tape.

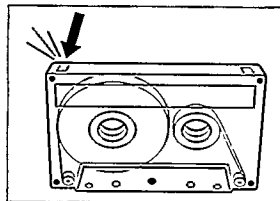

Recording from the CD player – CD synchro start

- 1 Set the POWER slider to CD.
- 2 Insert a CD and, if desired, program track numbers.
- 3 Press STOP-OPEN $\square\triangle$ to open the cassette compartment.
- 4 Insert a blank, unprotected cassette and close the cassette compartment.
- 5 Press RECORD \circ to start recording.
→ Playing of the CD or program starts automatically. It is not necessary to start the CD player separately.
- 6 For brief interruptions press PAUSE $\square\square$. Press the PAUSE $\square\square$ key again to resume recording.
- 7 To stop recording, press STOP-OPEN $\square\triangle$.

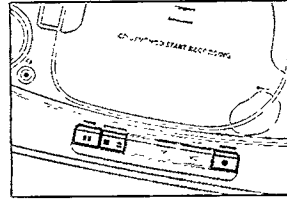

Note: the recording can be started from different positions:

- if the CD player is in pause mode, recording will start from this very position (use SEARCH $\ll\ll$ or $\gg\gg$);
- if the CD player is in stop mode, recording will start from the beginning of the CD or program.

Recording from the radio

- 1 Set the POWER slider to TUNER.
- 2 Tune to the desired radio station (see chapter "RADIO").
- 3 Press STOP-OPEN $\square\triangle$ to open the cassette compartment.
- 4 Insert a blank, unprotected cassette and close the cassette compartment.
- 5 Press RECORD \circ to start recording.
- 6 For brief interruptions press PAUSE $\square\square$. To resume recording press the PAUSE $\square\square$ key again.
- 7 To stop recording, press STOP-OPEN $\square\triangle$.

GENERAL INFORMATION

English

General maintenance

Do not expose the set, batteries, CDs or tapes to humidity, rain, sand or excessive heat (caused by heating equipment or direct sunlight).

The mechanical parts of the set contain self-lubricating bearings and must not be oiled or lubricated!

You can clean the set with a soft, slightly dampened lint-free cloth. Do not use any cleaning agents as they may have a corrosive effect.

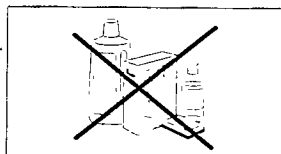
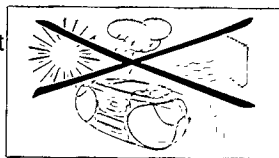

Tape deck maintenance

To ensure proper recording and playback quality, clean the parts (A), (B) and (C) after approx. 50 hours of operation. Use a cotton swab slightly moistened with alcohol or head-cleaner fluid.

Press PLAY ◀ and clean the rubber pressure rollers (C).

Press PAUSE ⏸ and clean the capstans (B) and the heads (A).

Note: Cleaning of the heads (A) can also be done by playing a cleaning tape once.

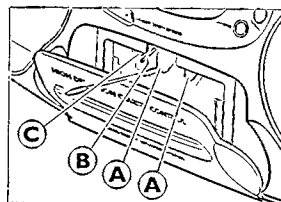

CD player and CD handling

The lens (X) of the CD player should never be touched. Always keep the CD compartment closed to avoid dust on the lens.

The lens may cloud over when the set is suddenly moved from cold to warm surroundings. Playing a CD is not possible then. Leave the CD player in a warm environment until the moisture evaporates.

To take the CD out of its box easily, press the centre spindle while lifting the CD. Always pick up the CD by the edge and put it back in its box after use.

To clean the CD, wipe it in a straight line from the center toward the edge using a soft, lint-free cloth. A cleaning agent may damage the disc!

Never write on a CD or attach a sticker to it.

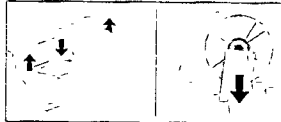
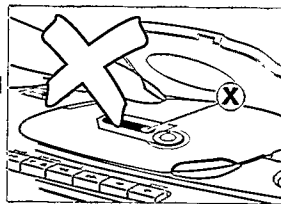

This set complies with the radio interference requirements of the European Community

TROUBLESHOOTING

WARNING

Under no circumstance should you try to repair the set yourself as this will invalidate the guarantee.

If a fault occurs, first check the points listed below before taking the set for repair.

If you are unable to solve a problem by following these hints, consult your dealer or service center.

Problem	Possible cause	Solution
No sound, no power	VOLUME is not adjusted.	Adjust volume.
	Headphone is connected.	Disconnect headphone.
	Mains cable is not securely connected.	Connect mains cable properly.
	Batteries are flat.	Insert fresh batteries.
	Batteries are inserted incorrectly.	Insert batteries correctly.
No reaction to operation of any keys	Trying to change over from mains to battery supply without removing the plug.	Remove the mains plug from the unit's AC MAINS inlet.
	Electrostatic discharge.	Disconnect the set from power supply, reconnect after a few seconds.
Poor radio reception	Weak radio signal.	Direct the antenna for optimum reception.
	Interference caused by vicinity of electrical equipment like TVs, computers, engines, etc..	Keep the radio away from electrical equipment.
no disc or Cd Err indication	The CD is badly scratched or dirty.	Replace or clean the CD.
	No CD is inserted.	Insert a CD.
	The CD is inserted upside down.	Insert CD with label upwards.
The CD skips tracks	The laser lens is steamed up.	Wait until the lens has cleared.
	The CD is damaged or dirty.	Replace or clean the CD.
Poor cassette sound quality	SHUFFLE or PROGRAM is active.	Switch off SHUFFLE or PROGRAM play.
	Dust and dirt on the heads, capstans or pressure rollers.	Clean heads, capstans, and pressure rollers.
Recording does not work	Use of unsuitable cassette types (METAL or CHROME) for recording.	Only use NORMAL type cassettes for recording.
	Cassette tab(s) may be snapped off.	Apply a piece of adhesive tape over the aperture.
Remote control does not function properly	Batteries are inserted incorrectly.	Insert batteries correctly.
	Batteries are flat.	Insert fresh batteries.
	Distance to the set is too large.	Reduce distance.

Meet Philips at the Internet
<http://www.philips.com>

English

Français

Español

Deutsch

Nederlands

Italiano

Svenska

Dansk

Suomi

Português

Ελληνικά

