

Always there to help you

Register your product and get support at
www.philips.com/welcome

AZ1137



User manual

PHILIPS

Contents

1	Important	2
	Safety	2
2	Your CD Soundmachine	3
	Introduction	3
	What's in the box	3
	Overview of the main unit	4
3	Get started	5
	Install batteries	5
	Connect power	6
4	Use your CD Soundmachine	6
	Play CD	6
	Listen to radio	6
	Control play	7
	Select play modes	7
5	Other features	7
	Program tracks	7
	Listen to an external device	7
6	Product information	8
7	Troubleshooting	8
8	Notice	9

1 Important

Safety



This 'bolt of lightning' indicates uninsulated material within the device may cause an electrical shock. For the safety of everyone in your household, please do not remove the covering.

The 'exclamation mark' calls attention to features for which you should read the enclosed literature closely to prevent operating and maintenance problems.

WARNING: To reduce the risk of fire or electric shock, the device should not be exposed to rain or moisture and objects filled with liquids, such as vases, should not be placed on the device.

CAUTION: To prevent electric shock, fully insert the plug. (For regions with polarized plugs: To prevent electric shock, match wide blade to wide slot.)

Important Safety Instructions

- Follow all instructions.
- Heed all warnings.
- Do not use this apparatus near water.
- Clean only with dry cloth.
- Do not block any ventilation openings. Install in accordance with the manufacturer's instructions.
- Do not install near any heat sources such as radiators, heat registers, stoves, or other device (including amplifiers) that produce heat.
- Protect the power cord from being walked on or pinched, particularly at plugs, convenience receptacles, and the point where they exit from the device.

- Only use attachments/accessories specified by the manufacturer.
- Use only with the cart, stand, tripod, bracket, or table specified by the manufacturer or sold with the device. When a cart is used, use caution when moving the cart/device combination to avoid injury from tip-over.



- Unplug this device during lightning storms or when unused for long periods of time.
- Refer all servicing to qualified service personnel. Servicing is required when the device has been damaged in any way, such as power-supply cord or plug is damaged, liquid has been spilled or objects have fallen into the device, the device has been exposed to rain or moisture, does not operate normally, or has been dropped.
- Battery usage CAUTION – To prevent battery leakage which may result in bodily injury, property damage, or damage to the device:
 - Do not mix batteries (old and new or carbon and alkaline, etc.).
 - Install the battery correctly, + and - as marked on the device.
 - The batteries shall not be exposed to excessive heat such as sunshine, fire or the like.
 - Remove battery when the device is not used for a long time.
- Device shall not be exposed to dripping or splashing.
- Do not place any sources of danger on the device (e.g. liquid filled objects, lighted candles).
- Where the plug of the Direct Plug-in Adapter is used as the disconnect device, the disconnect device shall remain readily operable.

Warning

- Never remove the casing of this device.
- Never lubricate any part of this device.
- Never place this device on other electrical equipment.
- Keep this device away from direct sunlight, naked flames or heat.
- Never look into the laser beam inside this device.
- Ensure that you always have easy access to the power cord, plug, or adaptor to disconnect this device from the power.

2 Your CD Soundmachine

Congratulations on your purchase, and welcome to Philips! To fully benefit from the support that Philips offers, register your product at www.philips.com/welcome.

Introduction

With the CD Soundmachine, you can:

- play CDs, MP3/wma discs;
- listen to FM/MW(AM) radio;
- program the play sequence of tracks.

What's in the box

Check and identify the contents of the package:

- Main unit (without batteries)
- 1 x AC/DC power adaptor
- 1 x MP3 LINK cable
- User Manual

Overview of the main unit

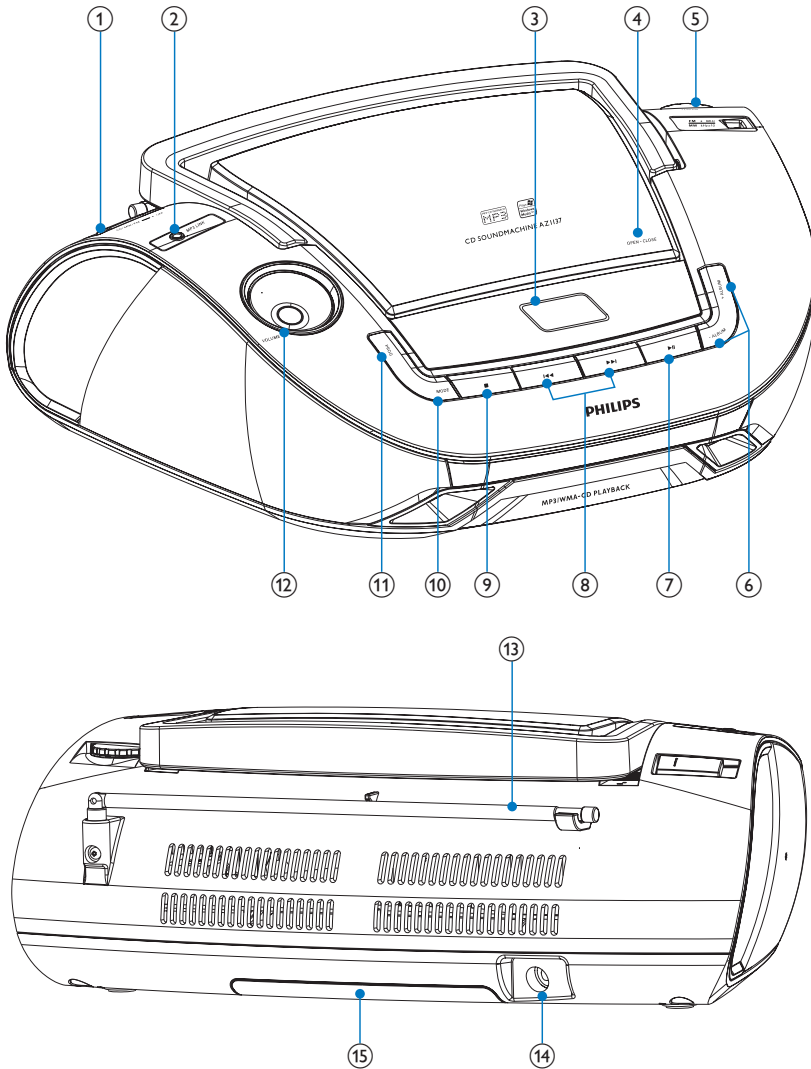

① Source selector: CD, MW, FM, OFF.

- Select a source: CD, MW(AM), or FM.
- Turn off the unit.

② MP3 LINK

- Socket for connecting an external device.

③ Display panel

- Show current status.

④ OPEN•CLOSE

- Press to open or close the disc compartment.

- ⑤ **TUNING**
 - Tune to radio stations.
- ⑥ **ALBUM+/-**
 - For MP3-CDs: skip to next/previous album in an MP3-CD.
- ⑦ **▶||**
 - Pause or resume play.
- ⑧ **◀◀ / ▶▶**
 - Select the previous/next track.
 - Search backward/forward.
- ⑨ **■**
 - Stop play.
 - Erase a program.
- ⑩ **MODE**
 - Select a play mode: REPEAT or SHUFFLE.
- ⑪ **PROG**
 - For MP3-CDs: program tracks and browse the program.
- ⑫ **VOL+/-**
 - Adjust volume.
- ⑬ **Telescopic antenna**
 - Adjust FM reception.
- ⑭ **DC IN**
 - Power supply socket.
- ⑮ **Battery compartment**

3 Get started

! Caution

- Use of controls or adjustments or performance of procedures other than herein may result in hazardous radiation exposure or other unsafe operation.

Always follow the instructions in this chapter in sequence.

If you contact Philips, you will be asked for the model and serial number of this apparatus. The model number and serial number are on the bottom of the apparatus. Write the numbers here:

Model No. _____

Serial No. _____

Install batteries

☰ Note

- You can use both batteries and AC power as power supply of this device.

- 1 Open the battery compartment.
- 2 Insert 6 × 1.5 V R14/UM2/C CELL batteries (not supplied) with correct polarity (+/-) as indicated.
- 3 Close the battery compartment.

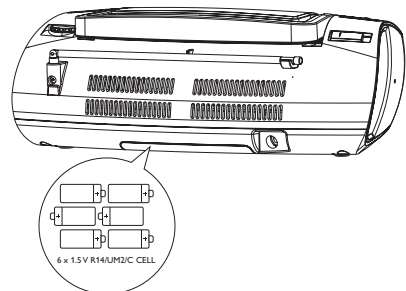

Connect power

! Caution

- Risk of product damage! Make sure that the power supply voltage corresponds to the voltage printed on the back or the underside of the product.
- Risk of electric shock! When you unplug the AC power cord, always pull the plug from the socket. Never pull the cord.
- Before you connect the AC power cord, make sure that you have completed all other connections.

☰ Note

- To save energy: switch the source selector to **OFF** after use.
- The device switches to standby mode if keeps inactive for 15 minutes.

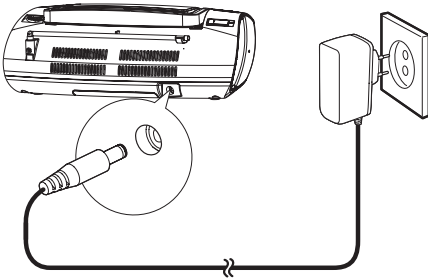

4 Use your CD Soundmachine

Play CD

☰ Note

- You cannot play CDs encoded with copyright protection technologies.

You can play commercially available audio CDs:

- CD-Recordables (CD-R)
- CD-Rewritables (CD-RW)
- MP3-CDs
- WMA-CDs

- 1 Switch the source selector to **CD**.
- 2 Press and open the lid of the CD compartment.
- 3 Insert a CD with the printed side facing up, and then close the CD lid.
- 4 Press **▶||** to start play.

Listen to radio

- 1 Switch the MW/FM selector to **MW** or **FM**.
- 2 Rotate **TUNING** until you find optimal reception.

✦ Tip

- To improve FM reception, you can extend, incline, or turn the telescopic antenna for best reception.
- To improve MW reception, turn the device to face a different direction.





Control play

Buttons	Functions
VOL	Rotate to adjust the volume.
■	Stop play.
▶	Pause or resume play.
◀◀ / ▶▶	Press to select a previous/next track. Press and hold to fast backward/ forward.

Note

- When search reaches the end of the last track, the CD stops.

Select play modes

- 1 Press **MODE** repeatedly to select a play mode:
 - [] (repeat) – repeat a track
 - [ ALL] (repeat all) - repeat an entire CD/program
 - [] (shuffle) - play tracks randomly
 - [ ALL] (shuffle repeat all)
- repeat all tracks randomly.
- 2 To return to normal play, press **MODE** repeatedly until play mode icons are no longer displayed.

Tip

- Shuffle play cannot be selected when you play programmed tracks.

5 Other features

Program tracks

You can program up to 20 tracks in the desired sequence.

- 1 In stop mode, press **PROG** to start to program play sequence.
↳ [**PROG**] and [**P01**] are displayed.
- 2 For MP3-CDs, press **- ALBUM +** to select an album.
- 3 Press **◀◀ / ▶▶** to select a track, and then press **PROG** to confirm.
- 4 Repeat steps 2 to 3 to program more tracks.
↳ When all 20 tracks are stored, no more tracks can be selected and [**FUL**] is displayed.
- 5 To play program, press **▶||**.
 - In stop mode, press and hold **PROG** to browse programmed tracks.
- 6 To delete program, press **■** in stop mode.
↳ [**CLr**] is displayed.

Listen to an external device

You can also listen to an external audio device through this unit.

For an audio device with a headphone socket:

- 1 Connect the supplied MP3 LINK cable between:
 - the **MP3-LINK** socket on the front of the unit.
 - and the headphone socket on an MP3 player.
- 2 Start to play the MP3 player. (See the user manual of the MP3 player.)

6 Product information

Note

- Product information is subject to change without prior notice.

Power supply	
- AC/DC power adaptor	Model: SEF0800100E1BA Input: 100-240V~, 50/60 Hz, 0.3 A Output: 8.0V == 1.0 A
- Battery	6 x 1.5 V R14/UM2/C CELL batteries
Power consumption	Active <12 W
Power output	2 x 1 W RMS
Operating temperature range	-10 °C - 50 °C 14 °F -122 °F
Dimensions (W x H x D)	341 x 122 x 236 mm
Weight	1.7 kg

7 Troubleshooting



Warning

- Never remove the casing of this device.

To keep the warranty valid, never try to repair the system yourself.

If you encounter problems when using this device, check the following points before requesting service. If the problem remains unsolved, go to the Philips Web page (www.philips.com/support). When you contact Philips, make sure that the device is nearby and the model number and serial number are available.

No power

- Make sure that the AC power plug of the unit is connected properly.
- Make sure that there is power at the AC outlet.
- Insert the batteries with their polarities (+/- signs) aligned as indicated.
- Replace the battery.

No sound

- Adjust the volume.
- Make sure that the track played is of a compatible format.

Cannot play disc

- Make sure that the disc label is inserted with the printed side facing up.
- Wipe the disc with fibre cleaning cloth from the centre to the edge in a straight line.
- This disc may be defective. Play another disc.
- Make sure that the CD is a finalized CD/CD-R/CD-RW.
- Make sure that the laser lens is clean.
- Make sure that the CD is not encoded with copyright protection technologies.

8 Notice

Any changes or modifications made to this device that are not expressly approved by WOOX Innovations may void the user's authority to operate the equipment.



This product complies with the radio interference requirements of the European Community.



Your product is designed and manufactured with high quality materials and components, which can be recycled and reused.



When this crossed-out wheeled bin symbol is attached to a product it means that the product is covered by the European Directive 2002/96/EC.

Please inform yourself about the local separate collection system for electrical and electronic products.

Please act according to your local rules and do not dispose of your old products with your normal household waste. Correct disposal of your old product helps to prevent potential negative consequences for the environment and human health.



Your product contains batteries covered by the European Directive 2006/66/EC, which cannot be disposed with normal household waste. Please inform yourself about the local rules on separate collection of batteries

because correct disposal helps to prevent negative consequences for the environmental and human health.

Environmental information

All unnecessary packaging has been omitted. We have tried to make the packaging easy to separate into three materials: cardboard (box), polystyrene foam (buffer) and polyethylene (bags, protective foam sheet.)

Your system consists of materials which can be recycled and reused if disassembled by a specialized company. Please observe the local regulations regarding the disposal of packaging materials, exhausted batteries and old equipment.

Recording and playback of material might require consent. See Copyright Act 1956 and The Performer's Protection Acts 1958 to 1972.



The making of unauthorized copies of copy-protected material, including computer programs, files, broadcasts and sound recordings, may be an infringement of copyrights and constitute a criminal offence. This equipment should not be used for such purposes.



Windows Media and the Windows logo are trademarks, or registered trademarks of Microsoft Corporation in the United States and/or other countries.

This apparatus includes these labels:



Class II equipment symbol



This symbol indicates that the apparatus has a double insulation system.



Note

- The type plate is located on the bottom of the apparatus.



Specifications are subject to change without notice

2013 © WOOX Innovations Limited. All rights reserved.

This product was brought to the market by WOOX Innovations Limited or one of its affiliates, further referred to in this document as WOOX Innovations, and is the manufacturer of the product. WOOX Innovations is the warrantor in relation to the product with which this booklet was packaged. Philips and the Philips Shield Emblem are registered trademarks of Koninklijke Philips N.V.

AZ1137_12_UM_V4.0

