

CD Radio Cassette Recorder

AZ 1110



Let's make things better.



PHILIPS

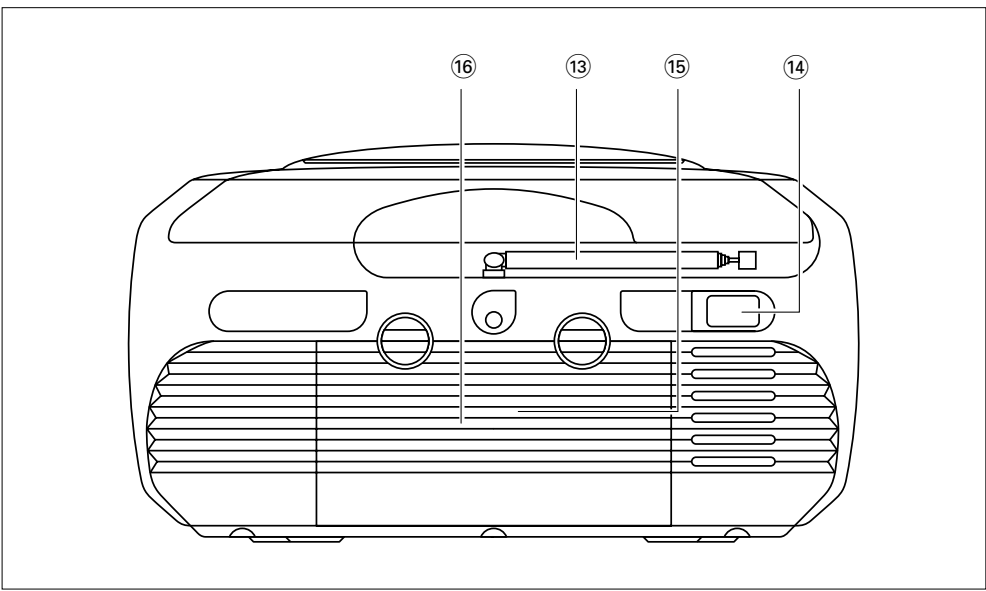
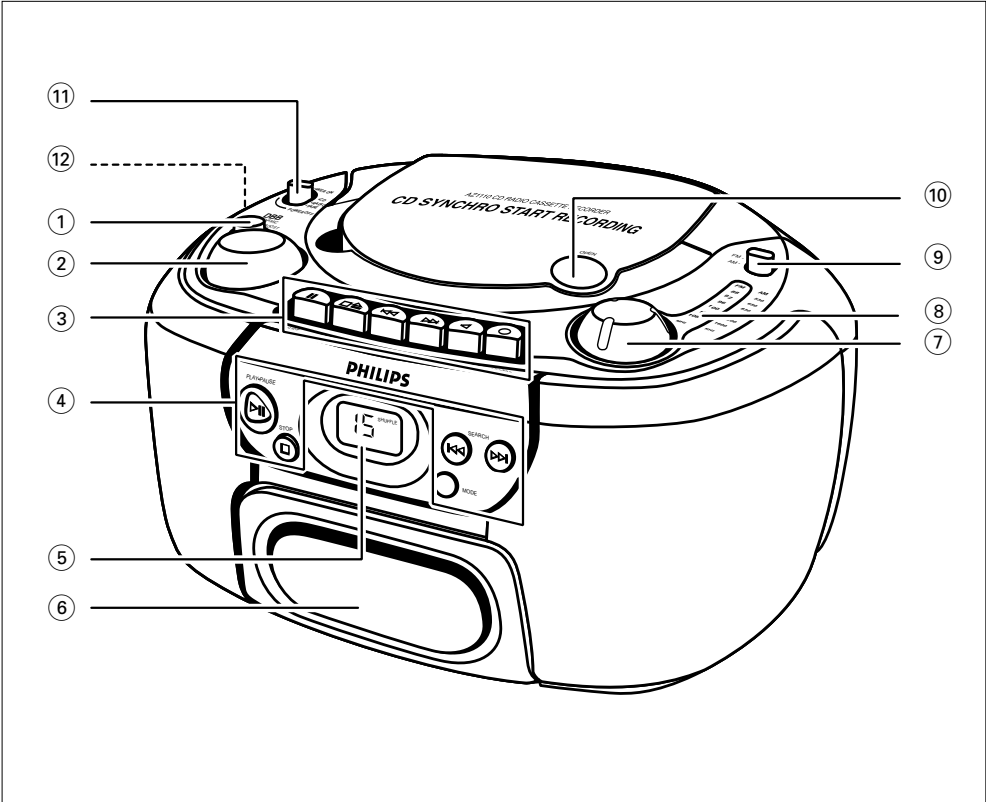

CONTROLS

English

TOP and FRONT PANEL

- ① **DBB (Dynamic Bass Boost)** – to increase the bass level
- ② **VOLUME** – to adjust the volume level
- ③ **Cassette keys**
 - PAUSE II** – to interrupt playback
 - STOP • OPEN ■ ▲** – to stop playback and open the cassette compartment
 - SEARCH ◀◀** – to fast forward the tape
 - SEARCH ▶▶** – to fast rewind the tape
 - PLAY ◀** – to start playback
 - RECORD ●** – to start recording
- ④ **CD buttons**
 - PLAY • PAUSE ▶II** – to start or interrupt CD playback
 - STOP ■** – to stop playback
 - SEARCH ◀◀ ▶▶** – to skip or search a passage or a track
 - MODE** – to select a different playback mode e.g. to SHUFFLE or REPEAT and to program track numbers
- ⑤ **CD display** – to indicate CD functions
- ⑥ **Cassette compartment**
- ⑦ **TUNING** – to tune to radio stations
- ⑧ **Tuning dial pointer**
- ⑨ **Band selector** – to select the wave band (FM-MW)
- ⑩ **OPEN** – to open the CD door
- ⑪ **Source selector** – POWER ON/OFF switch and to select the sound source: CD - RADIO - TAPE
- ⑫  – 3.5 mm headphone socket
Note: Connecting headphones will automatically disconnect the speakers

BACK PANEL

- ⑬ **Telescopic aerial** – To improve FM reception
- ⑭ **MAINS** – for mains lead
- ⑮ **Battery door** – to open the battery compartment
- ⑯ **Voltage selector** – (inside battery compartment)

Both the model and production numbers can be found on the bottom of the set.

BATTERIES

Whenever convenient, use the mains supply if you want to conserve battery life. Make sure you remove the mains plug from the set and wall socket before inserting batteries.

Batteries (optional)

1. Open the battery compartment and insert as shown six batteries, type R20, or D-cells.
2. Replace the compartment door, making sure the batteries are firmly and correctly in place.
3. Remove the batteries if exhausted or if they will not be used again for a long period.

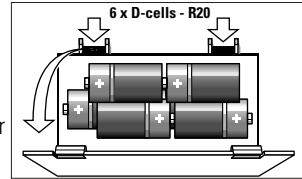

- The incorrect use of batteries can cause electrolyte leakage and will corrode the compartment or cause the batteries to burst. Therefore:
 - Do not mix battery types, e.g. alkaline with zinc carbonate.
 - When inserting new batteries, replace all batteries at the same time.

Batteries contain chemical substances, so they should be disposed of properly

Note: The battery supply is switched off when the set is connected to the mains.

MAINS

1. Check if the mains voltage as shown on the type plate (on the bottom of the set) corresponds to your local mains voltage. If it does not, consult your dealer or service organisation.
 2. If your set is equipped with a voltage selector, set it to the local mains voltage.
 3. Connect the mains lead to the MAINS socket and the wall socket.
 - The set is now ready to use.
 4. To switch off the mains supply completely, pull the mains plug out of the wall socket.
- Disconnect the mains lead when you change over to battery supply, or to protect the set during heavy thunderstorms.

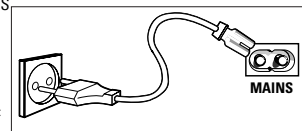

Environmental information

All redundant packaging material has been omitted. We have done our utmost to make the packaging easily separable into three mono materials: cardboard (box), expandable polystyrene (buffer) and polyethylene (bags, protective foam sheet).

Your set consists of materials which can be recycled if disassembled by a specialized company. Please observe the local regulations regarding the disposal of packaging materials, exhausted batteries and old equipment.

GENERAL OPERATION

1. To switch on the set, use the source selector
2. Adjust the sound using the VOLUME control and DBB switch.
3. To switch off the set, set the source selector to TAPE/POWER/OFF position, with the cassette keys released.



RADIO

1. Set the source selector to RADIO.
2. Adjust the sound using the VOLUME control and the DBB switch.
3. Select the wave band using the FM-MW band selector.
4. Tune to a radio station using the TUNING knob.
 - For FM, pull out the telescopic aerial. To improve FM-reception, incline and turn the aerial. Reduce its length if the FM-signal is too strong (very close to a transmitter).
 - For MW, the set is provided with a built-in aerial, so the telescopic aerial is not needed. Direct the aerial by turning the whole set.
5. To switch off the set, set the source selector to TAPE/POWER/OFF position, with the cassette keys released.

FM



MW



CD DISPLAY INDICATION

- Total track number: in stop position.
- Current track number: during CD play.
- Current track number flashes: in PAUSE mode.
- **SHUFFLE/REPEAT** mode: the respective mode is activated.
- **PROGRAM**: program function is active. P also appears briefly when you store a track.
- No display: error in CD operation or with the CD (see Troubleshooting).

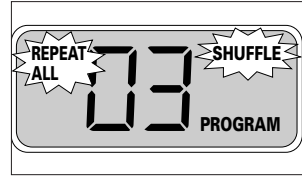

PLAYING A CD

1. Set the source selector to CD.
2. To open the CD compartment, press OPEN on the CD door.
3. Insert the audio CD, printed side facing up.
4. To close the CD compartment, push the door down.
 - The CD player scans the contents of the CD and the total number of tracks is displayed
5. Press PLAY•PAUSE ►|| to start playback.
6. Adjust the sound using the VOLUME control and the DBB switch.
7. To interrupt playback, press PLAY•PAUSE ►||.
 - Press PLAY•PAUSE ►|| again to continue playback.
8. Press STOP ■ to stop CD playback.
9. Set the source selector to TAPE/POWER/OFF position to switch off the set.

Note: CD playback will also stop when:

- the CD has reached the end;
- the CD door is opened;
- the source selector is in the RADIO or TAPE/POWER/OFF position.



SEARCH ◀◀ or ▶▶

Selecting a different track during playback

- You can jump to the next track by pressing SEARCH ▶▶ once. If you want to skip more than one track, press SEARCH ▶▶ more than once until the display shows the desired track number.
- If you want to repeat the running track from the beginning, press ◀◀ SEARCH once. If you want to repeat one of the previous tracks, press ◀◀ SEARCH more than once until the display shows the required track number.

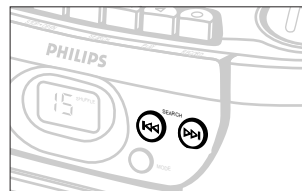

Starting with a particular track

1. In the STOP position you can select a desired track using the ◀◀ SEARCH or SEARCH ▶▶ button.
2. Press PLAY•PAUSE ►|| to start playback.

CD PLAYER

English

Searching for a passage within a track

You can search for a passage within a track. The CD is played at low volume and at high speed, however, the sound is still recognizable.

1. Keep the ◀◀ SEARCH or SEARCH ▶▶ button pressed during playback, and release the button as soon as you recognize the required passage:
 - Normal CD playback will resume from this point.

SHUFFLE/REPEAT

The MODE button allows you to select four different modes. The modes can be selected or changed during playback.

1. During playback only, press MODE until the desired function appears on the display.

REPEAT - Continuous playback of the current track.

SHUFFLE - Tracks are played in random order.

REPEAT ALL, SHUFFLE - Continuous playback of tracks in random order.

REPEAT ALL - Repeats the entire CD.

- During playback you can use ◀◀ SEARCH or SEARCH ▶▶ to skip tracks.
2. To leave the SHUFFLE mode, press the MODE button repeatedly until the various SHUFFLE/REPEAT modes are no longer shown on the display. You can also press STOP ■ to quit playback.

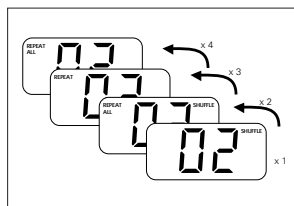

PROGRAMMING TRACK NUMBERS

You may store at most 20 tracks in the memory in the desired sequence. You may store any track more than once.

Programming track numbers

1. In the stop position select the desired track using ◀◀ SEARCH or SEARCH ▶▶ until the display shows the desired track number.
2. Store the desired track by pressing MODE once.
 - The display shows P and PROGRAM followed by your selected track number.
3. Select and store all desired tracks of a CD in this way.

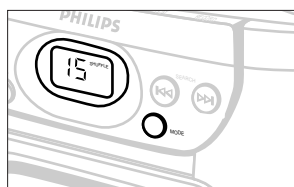

Checking a program

1. To review the set program, in the stop position press and hold MODE for more than 2 seconds.
 - The display will show the track numbers you have selected in sequence.
2. To start playback of the program, press PLAY • PAUSE ▶▶.
 - Playback starts with the first track of the program. After the last track, playback stops and the display shows the CD's total number of tracks.

PROGRAMMING TRACK NUMBERS

Erasing a program

You can erase a program by:

- opening the CD door.
- setting the source selector to the TAPE or RADIO position.
- pressing STOP twice during playback/in the stop position.

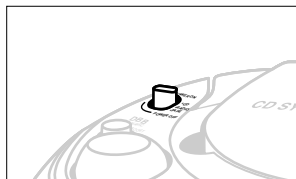

CASSETTE PLAYBACK

1. Set the source selector to TAPE.
2. Press STOP•OPEN ■ ▲ to open the cassette holder.
3. Insert a recorded cassette.
4. Press PLAY ◀ and playback will start.
5. Adjust the sound using the VOLUME, and DBB controls.
6. For brief interruptions, press PAUSE ■■. Press PAUSE ■■ again to resume playback.
7. By pressing ◀◀ or ▶▶, fast winding of the tape is possible in both directions.
8. To stop playback, press STOP•OPEN ■ ▲.
 - The keys are automatically released at the end of the tape.
9. Set the source selector to TAPE/POWER/OFF position (with the cassette keys released) to switch off the set.

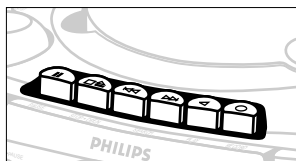

CASSETTE RECORDING

General information on cassette recording

- Recording is permissible insofar as copyright or other rights of third parties are not infringed.
- This deck is not suited for recording on CHROME (IEC II) or METAL (IEC IV) type cassettes. For recording you should use NORMAL type cassettes (IEC I) on which the tabs have not been broken.
- The recording level is set automatically. Altering the VOLUME control or, DBB switch will not affect the recording in progress.
- No recording will take place during the first 7 seconds, when the leader tape passes the recorder heads.
- To prevent the accidental erasure of a recording, keep the cassette side to be safeguarded in front of you and break out the left tab. Recording on this side is no longer possible.

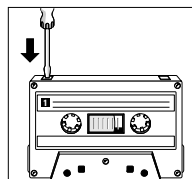

CASSETTE RECORDER

English

RECORDING FROM THE RADIO

1. Set the source selector to RADIO.
2. Tune to the desired radio station using the TUNING knob.
3. Press STOP•OPEN ■▲ to open the cassette holder.
4. Insert a blank cassette.
5. Press RECORD ● to start recording.
6. For brief interruptions, press PAUSE II. To resume recording, press PAUSE II again.
7. To stop, press STOP•OPEN ■▲.

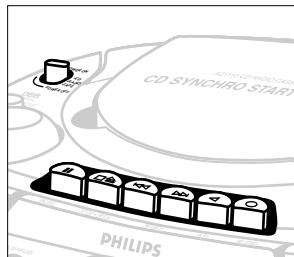

CD SYNCHRO START RECORDING

1. Set the source selector to CD.
2. Insert a CD and if desired, program track numbers.
3. Press STOP•OPEN ■▲ to open the cassette holder.
4. Insert a blank cassette.
5. Press RECORD ● to start recording.
 - Playing of the CD program starts automatically from the beginning of the program. It is not necessary to start the CD player separately.
6. For brief interruptions, press PAUSE II. To resume recording, press PAUSE II again.
7. To stop recording press STOP•OPEN ■▲.

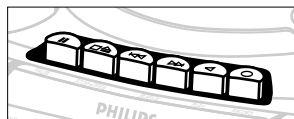

To select and record a particular passage within a track

1. Press ◀◀ SEARCH or SEARCH ▶▶ to select a passage.
2. Put the CD player in PAUSE II position at the selected passage.
 - Recording will start from this exact point when you press RECORD ●.

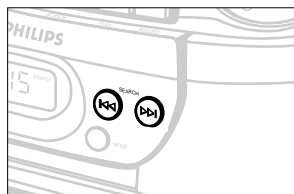

PRECAUTIONS & GENERAL MAINTENANCE

- Place the set on a hard, flat surface so that it does not tilt.
- Do not expose the set, CDs, batteries or cassettes to humidity, rain, sand, direct sunlight or other places where high temperatures can occur, such as in the vicinity of heating apparatus or in motor cars parked in the sun.
- Do not cover the set. The amplifier produces heat which must dissipate freely, so make sure that there is sufficient ventilation around the set. A minimum gap of 15 cm is necessary.
- The mechanical parts of the CD player and the cassette deck contain self-lubricating bearings and must not be oiled or lubricated.
- A chamois leather slightly moistened with water is sufficient for cleaning the housing. Do not use cleaning agents containing alcohol, spirits, ammonia or abrasives as these may harm the housing.

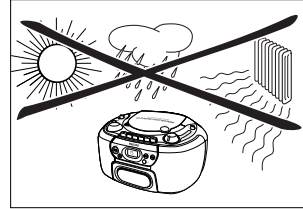

CD MAINTENANCE

- The lens of the CD player should never be touched.
- The lens may cloud over if the set is moved from cold to warm surroundings. The CD player will not start. Give the player some time to acclimatise.
- To take a CD out of its box, press the centre spindle while lifting the CD. Always pick up the CD by the edge and replace the CD back in its box after use to avoid scratching and dust.
- To clean the CD, wipe in a straight line from the centre towards the edge using a soft, lint-free cloth. Do not use cleaning agents as they may damage the disc.
- Never write on a CD or attach stickers to it.

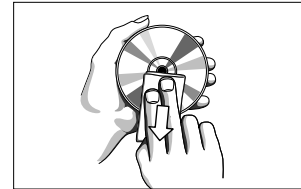

RECORDER MAINTENANCE

To ensure a good recording and playback quality, clean the indicated parts (A), (B) and (C) after every 50 hours of operation or, on average, once a month. Use a cotton bud slightly moistened with alcohol or a special head cleaning fluid.

- Press PLAY ◀ and clean the rubber pressure roller (C).
- Then press PAUSE || and clean the capstan (B) and the heads (A).
- After cleaning, press STOP•OPEN ■▲.

Cleaning of the heads (A) can also be done by playing a cleaning cassette through once.

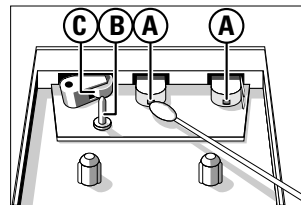

TROUBLESHOOTING

English

If a fault occurs, first check the points listed below before taking the set for repair.

If you are unable to remedy a problem by following these hints, consult your dealer or service centre.

WARNING: Under no circumstances should you try to repair the set yourself, as this would invalidate the guarantee.

PROBLEM	POSSIBLE CAUSE	REMEDY
Set does not react to operation of any control.	– Electrostatic discharge.	• Switch off the set, disconnect the mains plug and reconnect after a few seconds.
Display does not function properly.	– Electrostatic discharge.	• Switch off the set, disconnect the mains plug and reconnect after a few seconds.
No sound.	– VOLUME is not adjusted. – Headphones are connected. – Batteries are exhausted. – Batteries are incorrectly inserted. – Mains lead is not securely connected.	• Adjust the VOLUME. • Disconnect headphones. • Insert fresh batteries. • Insert the batteries correctly. • Connect the mains lead properly.
Bad sound.	– Batteries are exhausted.	• Replace batteries.
Severe radio hum or noise.	– Set too close to TV, VCR or computer.	• Increase the distance.
Poor radio reception.	– Weak radio signal.	• FM: aim and extend the telescopic aerial for best reception; • MW: rotate the entire set.
Poor cassette sound quality.	– Dust and dirt on the heads, capstan or pressure roller. – Use of incompatible cassette types (METAL or CHROME).	• Clean the heads etc., see Maintenance. – Only use NORMAL (IEC I) for recording.
Recording does not work.	– Cassette tab(s) may be broken out.	• Apply a piece of adhesive tape over the missing tab space.
CD playback does not work.	– CD is badly scratched or dirty. – No CD inserted. – CD inserted upside down. – Laser lens is steamed up. – MODE pressed but no tracks selected during programming.	• Replace or clean the CD, see Maintenance. • Insert CD. • Insert CD with printed side facing up. • Wait until lens has acclimatized. • Select tracks or erase program.
The CD skips tracks.	– CD is damaged or dirty. – PROGRAM/SHUFFLE is active.	• Replace or clean the CD. • Switch off the PROGRAM/-SHUFFLE function.