

PHILIPS

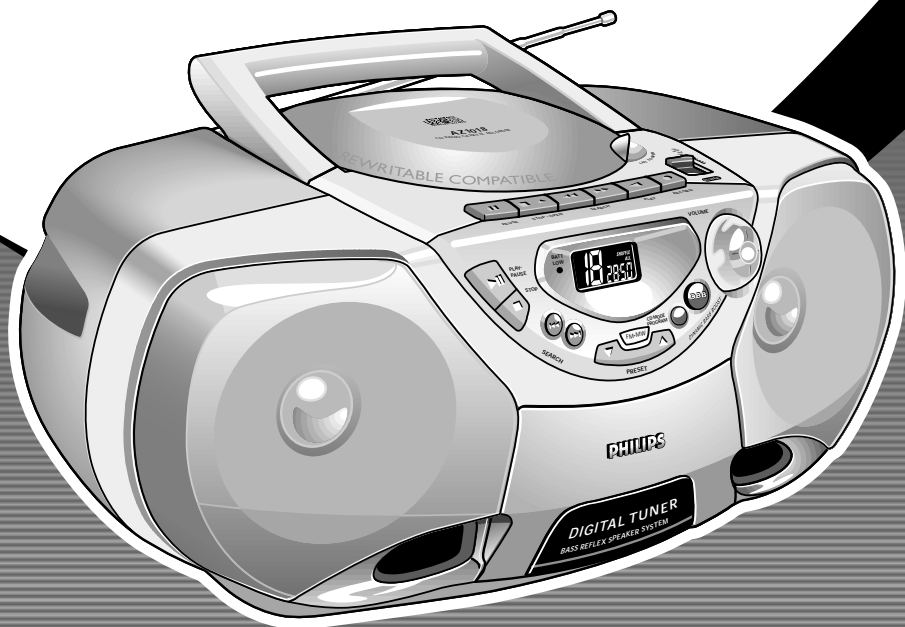

CD Radio
Cassette Recorder



Let's make things better.



PHILIPS

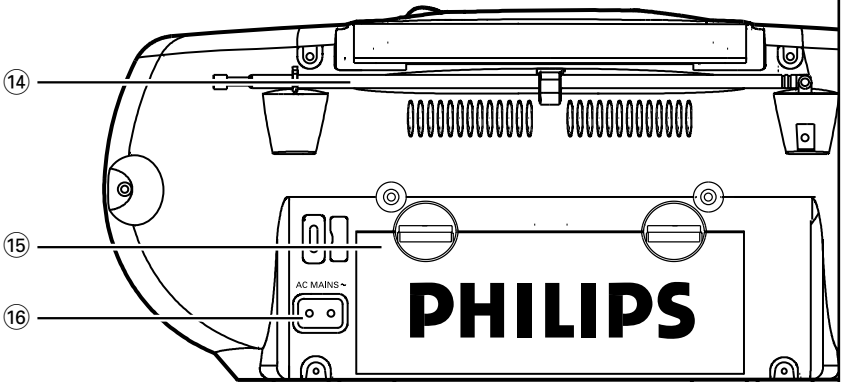
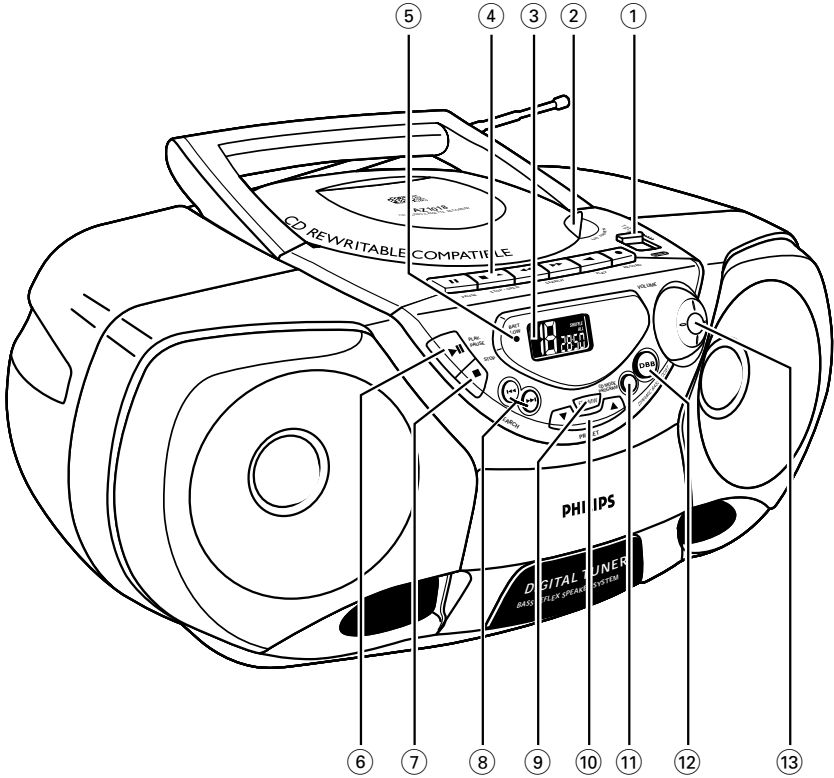

Top and front panels

- 1 **Power slider: CD, RADIO, TAPE/OFF** – selects source of sound CD, RADIO, TAPE/OFF, and the power on/ off switch
- 2 **LIFT TO OPEN** – opens/ closes the CD door
- 3 **Display** – shows the status of the set
- 4 **CASSETTE RECORDER:**
PAUSE II – pauses recording or playback
STOP•OPEN ■▲ – stops the tape; opens the cassette door
SEARCH ◀◀ or ▶▶ – fast rewinds / winds the tape
PLAY ◀ – starts playback
RECORD ● – starts recording
- 5 **BATT LOW** – indicator lights up if battery power is running low
- 6 **PLAY•PAUSE ▶▶** – starts or pauses CD playback
- 7 **STOP ■** – stops CD playback; erases a CD programme
- 8 **SEARCH ◀◀ , ▶▶**
 CD: skips or searches a passage/track backwards or forward
 RADIO – tunes to a radio station (up, down)
- 9 **FM•MW** – selects FM/ MW (AM) waveband
- 10 **PRESET ▲, ▼** – selects a preset station (up, down)
- 11 **CD MODE/ PROGRAM**
 CD – programmes and reviews programmed track numbers;
 – plays tracks CD/ programme in random order;
 – repeats a track/CD/ programme
 RADIO – programmes radio preset stations

12 **DBB (Dynamic Bass Boost)** – enhances bass response

13 **VOLUME** – adjusts volume level

Back Panel

14 **Telescopic aerial** – to improve FM reception

15 **Battery door** – open to insert 6 x 1.5V R14/UM2/ C-cell batteries

16 **AC MAINS** – inlet for mains lead

Power Supply

Whenever convenient, use the power supply if you want to conserve battery life.

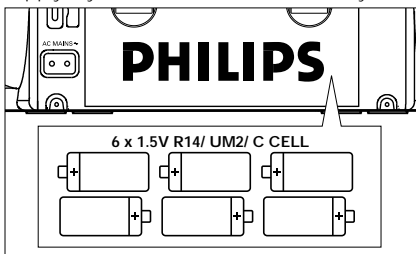

Make sure you remove the plug from the set and wall socket before inserting batteries.

For users in the U.K.: please follow the instructions on page 2.

Batteries (not included)

- 1 Open the battery compartment and insert six batteries, type **R-14**, **UM-2** or **C-cells**, (preferably alkaline) with the correct polarity as indicated by the "+" and "-" symbols inside the compartment.
- 2 Close the compartment door, and make sure the batteries are firmly and correctly in place. The set is now ready to operate.
 → If **BATT LOW** lights up, battery power is running low. The **BATT LOW** indicator eventually goes out if the batteries are too weak.

Batteries contain chemical substances, so they should be disposed of properly.

Incorrect use of batteries can cause electrolyte leakage and will corrode the compartment or cause the batteries to burst. Therefore:

- Do not mix battery types: e.g. alkaline with carbon zinc. Only use batteries of the same type for the set.
- When inserting new batteries, do not try to mix old batteries with the new ones.
- Remove the batteries if the set is not to be used for a long time.

Using AC Power

- 1 Check if the mains voltage, as shown on the **type plate located on the bottom of the set**, corresponds to your local mains supply. If it does not, consult your dealer or service centre.

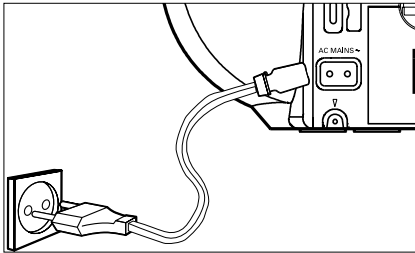

- 2 Connect the mains lead to the AC MAINS inlet and the wall socket. The power supply is now connected and ready for use.
 - 3 To switch off completely, unplug the mains lead from the wall socket.
- Unplug the mains lead from the wall socket to protect your set during heavy thunderstorms.

The type plate is located on the bottom of the set.

Switching power on/off: Save energy

Whether you are using mains or battery supply, to avoid unnecessary energy consumption always adjust the **POWER slider** to **TAPE/OFF** and check if the cassette keys are released.

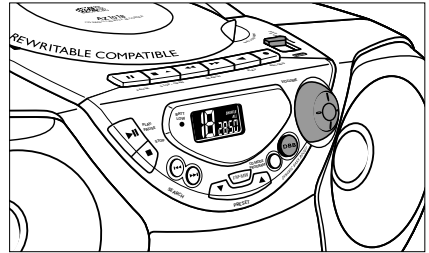

General operation

- 1 To select your sound source adjust the **POWER slider** to **CD, RADIO** or **TAPE/OFF**.
- 2 Adjust the sound with the **VOLUME** and **DBB** (Dynamic Bass Boost) controls.
- 3 To switch off the set, adjust the **POWER slider** to **TAPE/OFF** position and check the cassette keys are released.

Note: When the set is switched off the tuner presets will be retained in the set's memory.

Radio

Radio reception

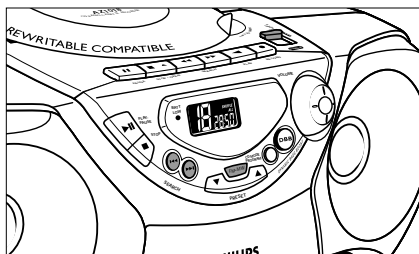

- 1 Adjust the **POWER slider** to **RADIO**.
→ Display: shows FM briefly. The radio frequency is then shown.
 - 2 Press **FM•MW** once or more to select the desired waveband.
→ Display: shows your waveband
 - 3 Press and hold down **SEARCH** \lll or \ggg briefly to tune to a radio station. Release when the frequency in the display starts to change.
→ The radio automatically tunes to a radio station of sufficient reception. Display shows SEARCH during automatic tuning.
- To tune to a weak station, press **SEARCH** \lll or \ggg briefly and repeatedly until you have found optimal reception.

To improve reception

– For **FM**, pull out the telescopic aerial. Incline and turn the aerial. Reduce its length if the signal is too strong (very close to a transmitter).

– For **MW (AM)** the set is provided with a built-in aerial so the telescopic aerial is not needed. Direct the aerial by turning the whole set.

- 4 To switch off the radio, adjust the **POWER slider** to **TAPE/OFF** position and check the cassette keys are released.

Programming radio stations

You can store up to a total of 30 radio stations in the memory.

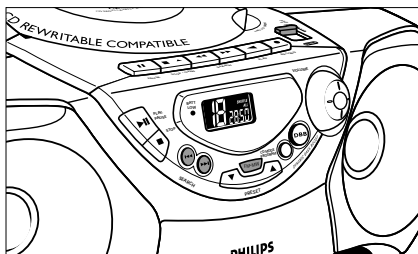

- 1 Tune to your desired station (see Radio Reception).
 - 2 Press **CD MODE/ PROGRAM** to activate programming.
→ Display: **PROGRAM** flashes.
 - 3 Press **PRESET** \blacktriangle or \blacktriangledown once or more to allocate a number from 1 to 30 to this station.
 - 4 Press **CD MODE/ PROGRAM** again to confirm the setting.
→ Display: **PROGRAM** disappears, the preset number and the frequency of the preset station are shown.
 - 5 Repeat the above four steps to store other stations.
- You can erase a preset station by storing another frequency in its place.

Tuning to preset stations

Press **PRESET** \blacktriangle or \blacktriangledown until the desired preset station is shown.

CD Player

Display indication

- *CD OPEN*: CD door open
- *d 15*: when reading CD contents
- **In stop mode**: total track number and total playback time
- **During CD playback**: elapsed playback time of current track and current track number
- **Pause**: elapsed playback time freezes and flashes
- **SHUFFLE/ REPEAT** modes: when the respective mode is activated
- **PROGRAM**: when CD programme active; *prog* also appears briefly when you store a track
- *no SEL*: programme activated but no tracks selected
- *FULL*: programme memory full
- *no prog*: programme cancelled
- *CD Err, no d 15* or *no F d 15*: error in CD operation /no disc/ or a CD-R(W) is blank or the disc is not finalized (see Troubleshooting)

Playing a CD

This CD-player can play all kinds of Audio Discs such as CD-Recordables and CD-Rewritables. Do not try to play a CD-ROM, CDi, VCD, DVD or computer CD.

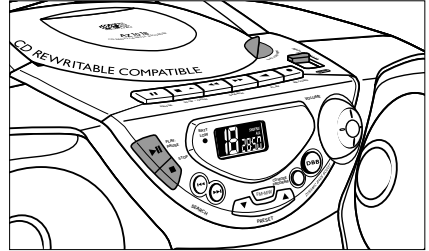

- 1 Adjust the **POWER slider** to **CD**.
→ Display: shows *CD* briefly.
- 2 To open the CD door, lift the CD door at the edge marked **LIFT TO OPEN**.
- 3 Insert a CD or CD-R(W) with the printed side facing up and press the CD door gently close.
- 4 Press **PLAY•PAUSE ►||** on the set to start playback.
- 5 To pause playback press **PLAY•PAUSE ►||**. To resume, press **PLAY•PAUSE ►||** again.
→ The elapsed playback time freezes and flashes.
- 6 To stop CD playback, press **STOP ■**.
- 7 To switch off the set, adjust the **POWER slider** to **TAPE/OFF** position and check the cassette keys are released.

Note: CD play will also stop when:

- you open the CD compartment;
- you select **RADIO** or **TAPE** sound source;
- the CD has reached to the end.

CD-Player

Selecting a different track

During playback you can use the **SEARCH** buttons to select a particular track.

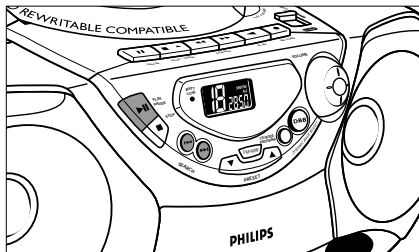

- If you have selected a track number in the stop or pause position, press **PLAY•PAUSE** **▶▶** to start playback.
- Press **SEARCH** **▶▶** once briefly for the next track, or press repeatedly until the desired track number appears in the display.
- Press **SEARCH** **◀◀** once briefly to return to the beginning of a current track.
- Press **SEARCH** **◀◀** more than once briefly for a previous track.

Finding a passage within a track

- 1 During playback, press and hold down **SEARCH** **◀◀** or **▶▶**.
 - The CD is played at high speed and low volume.
- 2 When you recognize the passage you want release the **SEARCH** button.
→ Normal playback resumes.

Note: During a CD programme or when SHUFFLE/REPEAT is active, searching is only possible within a track.

Different play modes

CD MODE/ PROGRAM allows you to select various play modes. The modes can be selected or changed during playback of an entire CD/ CD programme in the following sequence:

SHUFFLE – all tracks are played in random order

SHUFFLE REPEAT ALL – repeats the entire CD in random order

REPEAT – plays the current track continuously

REPEAT ALL – plays the entire CD continuously

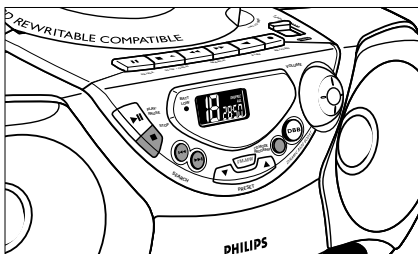

- 1 During playback, select your play mode by pressing **CD MODE/ PROGRAM** once or more until the desired play mode is shown.
 - You can use **SEARCH** **◀◀** or **▶▶** to skip tracks during the **SHUFFLE/ REPEAT** modes.
 - The **SHUFFLE/ REPEAT** play options can be combined and used with a programme: e.g. **SHUFFLE/ REPEAT ALL** repeats the entire CD programme in random order.
- 2 To return to normal playback press **CD MODE/ PROGRAM** until the **SHUFFLE/ REPEAT** modes are no longer shown.
 - You can also press **STOP** **■** to quit the play mode.

Programming track numbers

You may store up to 20 tracks in the desired sequence. If you like, store any track more than once.

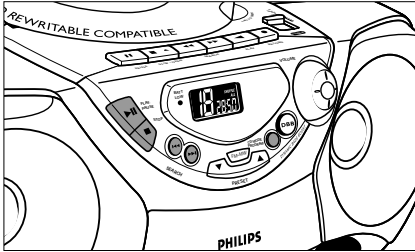

- 1 In the STOP mode, press **SEARCH** ◀◀ or ▶▶ for your desired track.
- 2 When your chosen track number appears, press **CD MODE/ PROGRAM** once to store the track.
 - The display shows **PROGRAM** and 'PROGRAM' briefly followed by your selected track number.
 - If you attempt to programme without first selecting a track number, *NO SEL* is shown.
- 3 Repeat steps 1 to 2 to select and store all desired tracks in this way.
 - *FULL* is displayed if you attempt to programme more than 20 tracks.
- 4 To play your programme, press **PLAY•PAUSE** ▶||.

Reviewing your programme

- In the STOP mode, press and hold down **CD MODE/ PROGRAM** for more than one second.
 - The display shows all your stored track numbers in sequence.

Erasing a programme

You can erase the contents of the memory by:

- opening the CD door;
- selecting **RADIO** or **TAPE** source;
- pressing **STOP** ■ (twice during playback or in the stop position.)
- Display: shows 'NO PROGRAM' briefly when the programme is cancelled.

CASSETTE RECORDER

Cassette playback

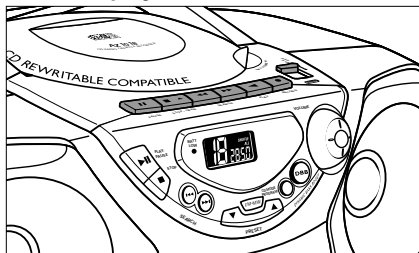

- 1 Adjust the **POWER** slider to **TAPE/OFF**.
 - 2 Press **STOP-OPEN** ■▲ to open the cassette door and insert a recorded cassette.
 - 3 Close the cassette door.
 - 4 Press **PLAY** ◀ to start playback.
→ Display: shows *⋈ R P E* throughout tape operation.
 - 5 To pause playback press **PAUSE** ■■. To resume, press the key again.
 - 6 By pressing ◀◀ or ▶▶, fast winding of the tape is possible in both directions. To stop fast winding, press **STOP-OPEN** ■▲.
 - 7 To stop the tape, press **STOP-OPEN** ■▲.
- The keys are automatically released at the end of the tape, the *⋈ R P E* indication goes out and the set is switched off, except if **PAUSE** ■■ has been activated.

General information on recording

- Recording is permissible insofar as copyright or other rights of third parties are not infringed.
- This deck is not suited for recording on CHROME (IEC II) or METAL (IEC IV) type cassettes. For recording, use only NORMAL type cassettes (IEC type I) on which the tabs have not been broken.
- *The best recording level is set automatically.* Altering the **VOLUME** and **DBB** controls will not affect the recording in progress.
- At the very beginning and end of the tape, no recording will take place during the 7 seconds when the leader tape passes the recorder heads.
- To protect a tape from accidental erasure, have the tape in front of you and break out the left tab. Recording on this side is no longer possible. To record over this side again, cover the tabs with a piece of adhesive tape.

Synchro Start CD recording

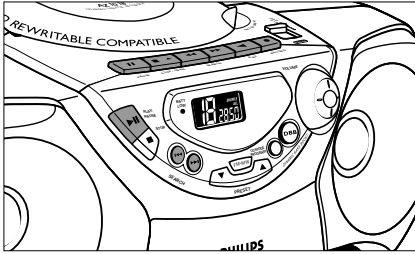

- 1 Select CD source.
- 2 Insert a CD and if desired, programme track numbers.
- 3 Press **STOP-OPEN** **■▲** to open the cassette door. Insert a blank tape.
- 4 Close the cassette door.
- 5 Press **RECORD** **●** to start recording.
 - Playing of the CD programme starts automatically from the beginning of the programme. *It is not necessary to start the CD player separately.*
- 6 For brief interruptions press **PAUSE II**. To resume recording, press **PAUSE II** again.
- 7 To stop recording, press **STOP-OPEN** **■▲**.

Selecting and recording a particular passage

- During CD playback, press and hold down the **SEARCH** buttons **◀◀** or **▶▶** on the set to find your passage.
- Press **PLAY-PAUSE** **▶II** to put the CD player on pause at the selected passage.
 - Recording will begin from this exact point in the track when you press **RECORD** **●**.

Recording from the Radio

- 1 Select **RADIO** source and your waveband.
- 2 Tune to the desired radio station (see **Radio reception**).
- 3 Press **STOP-OPEN** **■▲** to open the cassette door. Insert a blank tape.
- 4 Close the cassette door.
- 5 Press **RECORD** **●** to start recording.
- 6 For brief interruptions, press **PAUSE II**. To resume recording, press **PAUSE II** again.
- 7 To stop recording, press **STOP-OPEN** **■▲**.

Precautions & General Maintenance

- Place the set on a hard and flat surface so that the system does not tilt.
- Do not expose the set, batteries, CDs or cassettes to humidity, rain, sand or excessive heat caused by heating equipment or direct sunlight.
- Do not cover the set. Adequate ventilation with a minimum gap of 6 inches between the ventilation holes and surrounding surfaces is necessary to prevent heat build-up.
- The mechanical parts of the set contain self-lubricating bearings and must not be oiled or lubricated.
- To clean the set, use a soft, slightly dampened chamois leather. Do not use any cleaning agents containing alcohol, ammonia, benzene or abrasives as these may harm the housing.

Maintenance

Tape deck maintenance

To ensure quality recording and playback of the tape deck, clean parts (A), (B) and (C) shown in the diagram below, after approx. 50 hours of operation, or on average once a month. Use a cotton bud slightly moistened with alcohol or a special head cleaning fluid to clean the deck.

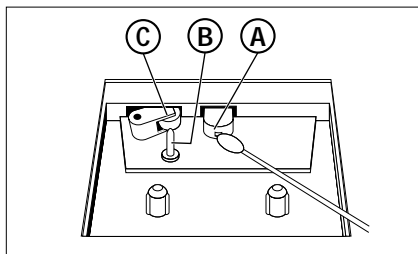

- 1 Open the cassette door by pressing **STOP•OPEN** ■▲.
 - 2 Press **PLAY** ◀ and clean the rubber pressure roller (C).
 - 3 Press **PAUSE** ■■ and clean the magnetic heads (A), and also the capstan (B).
 - 4 After cleaning, press **STOP•OPEN** ■▲.
- Cleaning of the heads can also be done by playing a cleaning cassette through once.

CD player and CD handling

- The lens of the CD player should never be touched!
- Sudden changes in the surrounding temperature can cause condensation to form and the lens of your CD player to cloud over. Playing a CD is then not possible. Do not attempt to clean the lens but leave the set in a warm environment until the moisture evaporates.
- Use only Digital Audio CDs.
- Always close the CD door to keep the CD compartment dust-free. To clean, dust the compartment with a soft dry cloth.
- To take a CD out of its box, press the centre spindle while lifting the CD. Always pick up the CD by the edge and replace the CD back in its box after use to avoid scratching and dust.
- To clean the CD, wipe in a straight line from the centre towards the edge using a soft, lint-free cloth. Do not use cleaning agents as they may damage the disc.
- Never write on a CD or attach any stickers to it.

Environmental information

All unnecessary packaging material has been omitted. The packaging can be easily separated into three materials: cardboard, polystyrene and plastic.

Your set consists of materials which can be recycled if disassembled by a specialized company. Please observe the local regulations regarding the disposal of packing materials, exhausted batteries and old equipment.

If a fault occurs, first check the points listed below before taking the set for repair. Do not open the set as there is a risk of electric shock.

If you are unable to remedy a problem by following these hints, consult your dealer or service centre.

WARNING: Under no circumstances should you try to repair the set yourself, as this will invalidate the guarantee.

Problem	Solution
No sound	– Adjust the VOLUME
No power	– Mains lead not securely connected. Connect AC mains lead properly – Batteries exhausted /incorrectly inserted. Insert (fresh) batteries correctly
Display does not function properly/ No reaction to operation of any of the controls	– Electrostatic discharge Switch off and unplug the set. Reconnect after a few seconds.
no d 15C, Cd Err or nF d 15C indication	– No CD inserted, insert a CD – CD badly scratched/ dirty. Replace/ clean CD (see maintenance) – CD-R(W) is blank or the disc is not finalized. Use a finalized CD-R(W) – Laser lens steamed up. Wait until lens has acclimatized
Laser lens steamed up	– Wait until lens has cleared – Wait until lens has acclimatized
CD playback does not work	– CD badly scratched/ dirty. Replace/ clean CD (see maintenance)
The CD skips tracks	– CD damaged or dirty. Replace or clean CD. – Programme is active. Quit programme mode
Poor cassette sound quality	– Dust and dirt on the heads, etc. Clean deck parts, see maintenance. – Use of incompatible cassette types (METAL or CHROME). Only use NORMAL (IEC I) for recording
Recording does not work	– Cassette tab(s) may be broken. Apply a piece of adhesive tape over the missing tab space.