

# PHILIPS

AZ 1009 – AZ 1010 CD Radio Cassette Recorder

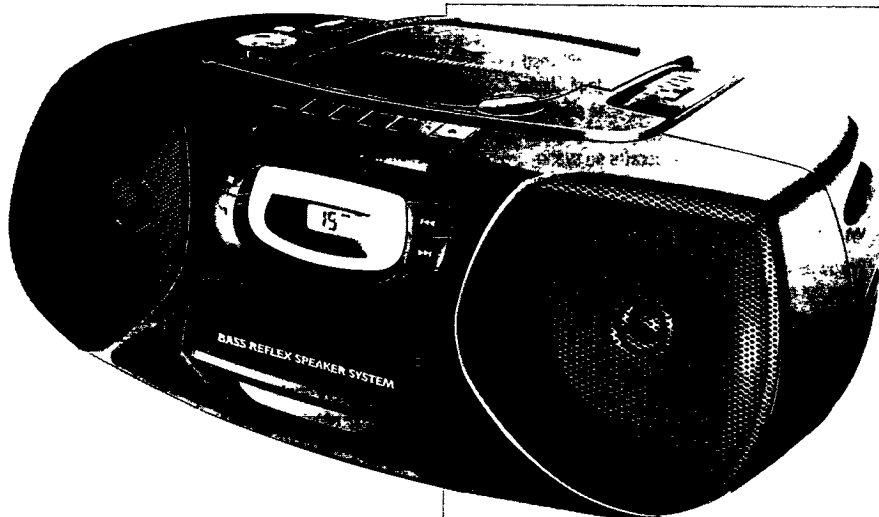

Instructions for use  
Руководство по эксплуатации  
Instrukcja obsługi  
Návod k obsluze  
Návod na použitie  
Használati útmutató



**PHILIPS**

## ČESKA REPUBLIKÁ

### Vystraha!

Tento přístroj pracuje s laserovým paprskem. Při nesprávné manipulaci s přístrojem (v rozporu s tímto návodem) může dojít k nebezpečnému ozáření. Proto přístroj za chodu neotevírejte ani nesaňmejte jeho kryty. Jakoukoli opravu vždy svěřte specializovanému servisu.

### Nebezpečí!

Při sejmutí krytů a odjištění bezpečnostních spínačů hrozí nebezpečí neviditelného laserového záření!

**Chraňte se před přímým zásahem laserového paprsku.**

### Záruka

Tento přístroj byl vyroben s největší pečlivostí a nejmodernějšími výrobními metodami. Jsme přesvědčeni, že vám bude bezchybně sloužit, pokud budete dodržovat pokyny v návodu. V případě jakékoli závady se laskavě obraťte na svého obchodníka nebo přímo na servisní organizaci firmy Philips. Dbejte též, aby vám prodávající řádně vyplnil záruční list.

Pokud by však byly na přístroji shledány cizí zásahy, nebo byl obsluhován v rozporu s pokyny v návodu, záruční nároky zanikají. Záruční doba je dvanáct měsíců ode dne prodeje.

Pokud byste z jakéhokoli důvodu přístroj demontovali, vždy nejdříve vytáhněte síťovou zástrčku.

Přístroj chraňte před jakoukoli vlhkostí i před kapkami vody.

## MAGYARORSZÁG

### Minőségtanúsítás

A garanciajegyven feltüntetett forgalombahozó vállalat a 2/1984. (III.10.) BkM-lpM együttes rendelet értelmében tanúsítja, hogy ezen készülék megfelel a műszaki adatokban megadott értékeknek.

### Figyelem!

A meghibásodott készüléket - beleértve a hálózati csatlakozót is - csak szakember (szerviz) javíthatja.

Ne tegye ki a készüléket esőnek vagy nedvesség hatásának!

### Garancia

A forgalombahozó vállalat a termékre 12 hónap garanciát vállal.

Névleges feszültség .....220–230 V  
Elemes működéshez .....6 × R20  
Névleges frekvencia .....50 Hz

### Teljesítmény

maximális .....≤ 20 W  
névleges .....8 W  
készületi állapotban .....≤ 5 W

### Érintésvédelmi osztály II.

Tömeg .....3,5 kg

### Befoglaló méretek

szélesség .....435 mm  
magasság .....170 mm  
mélység .....152 mm

### Rádiórész vételi tartomány

URH .....87,5–108 MHz  
Középhullámú .....522–1607 kHz

### Erősítőrész

Kimeneti teljesítmény .....60 W PMPO  
2 × 1,4 W RMS

## SLOVAK REPUBLIC

Přístroj sa nesmie používať v mokrom a vlhkom prostredí! Chráňte pred striekajúcou a kvapkajúcou vodou!

<b>English</b>	Controls.....	4	CD player.....	7–9	<b>English</b>
	Power supply .....	5	Cassette recorder.....	10–11	
	Basic fuctions .....	6	General information.....	12	
	Radio.....	6	Troubleshooting .....	13	
<b>Русский</b>	Кнопки управления.....	14	Проигрыватель CD.....	17–19	<b>Русский</b>
	Питание .....	15	Магнитофон.....	20–21	
	Основные функции .....	16	Общая информация.....	22	
	Радио.....	16	Устранение неисправностей	23	
<b>Polski</b>	Opis przełączników .....	24	Odtwarzacz CD .....	27–29	<b>Polski</b>
	Zasilanie .....	25	Magnetofon .....	30–31	
	Podstawowe funkcje .....	26	Informacje ogólne.....	32	
	Radio .....	26	Usuwanie usterek.....	33	
<b>Česky</b>	Ovládací tlačítka .....	34	Přehrávač CD .....	37–39	<b>Česky</b>
	Napájení .....	35	Kazetový magnetofon....	40–41	
	Základní funkce.....	36	Všeobecné informace .....	42	
	Radiopřijímač.....	36	Přehled možných závad .....	43	
<b>Slovensky</b>	Ovládacie gombíky.....	44	Prehrávač CD .....	47–49	<b>Slovensky</b>
	Napájanie .....	45	Kazetový magnetofón....	50–51	
	Základné funkcie.....	46	Všeobecné informácie .....	52	
	Rádioprijímač.....	46	Prehľad možných chýb .....	53	
<b>Magyar</b>	Vezérlő gombok .....	54	CD-lejátszó .....	57–59	<b>Magyar</b>
	Tápfeszültség.....	55	Magnetofon .....	60–61	
	Alapfunkciók .....	56	Általános információk.....	62	
	Rádió.....	56	Hibakeresés .....	63	

# CONTROLS

English

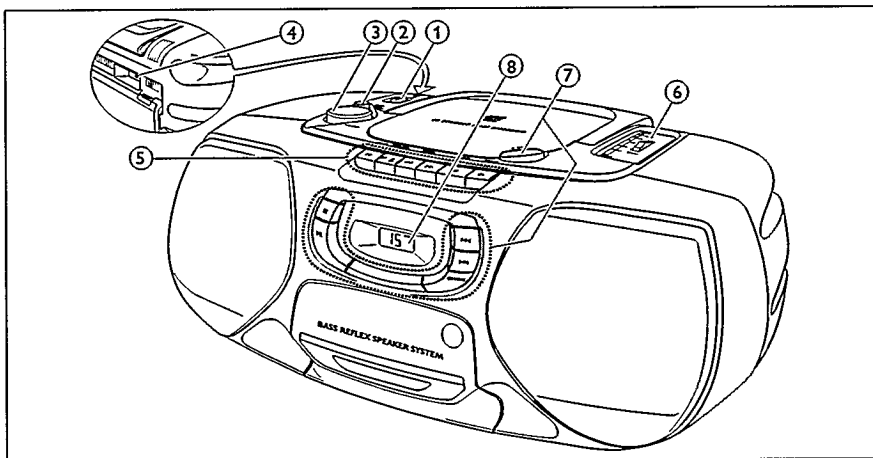

## BASIC FUNCTIONS

- ① **POWER:**  
CD, TAPE, BAND .....selects the sound source
- ② **DBB** .....enhances the bass
- ③ **VOLUME** .....adjusts the volume level
- ④ .....3.5mm headphone socket  
(back of the set)

*Note: Connecting the headphones will switch off the speakers.*

## ⑤ CASSETTE RECORDER

- PAUSE** .....interrupts recording or playback
- STOP-OPEN** .....stops the tape and opens the cassette compartment
- SEARCH** .....rewinds the tape
- SEARCH** .....fast forwards the tape
- PLAY** .....starts playback
- RECORD** .....starts recording

## RADIO

- ⑥ **TUNING** .....tunes to radio stations
- ① **BAND:** FM, MW .....selects the wave band

## ⑦ CD PLAYER

- OPEN** .....opens the CD compartment
- .....stops CD play and erases the program
- .....starts and interrupts CD play
- .....skips and searches forward
- .....skips and searches backward
- CD MODE** .....selects the different CD playing modes and programs tracks

⑧ **Display**

# POWER SUPPLY

English

## Batteries (optional)

Open the battery compartment of the set and insert 6 batteries, type **R20**, **UM-1** or **D**-cells (preferably alkaline).

Remove batteries if they are flat or if the set is not going to be used for a long time.

**Batteries contain chemical substances, so they should be disposed of properly.**

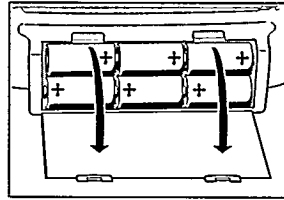

## Mains

- 1 Check whether the mains voltage as shown on the type plate corresponds to your local mains voltage. If it does not, consult your dealer or service organisation. **The type plate is located on the bottom of the set.**
- 2 If the set is equipped with a VOLTAGE selector (A), set this selector to the local mains voltage.
- 3 Connect the mains cable to the AC MAINS socket and the wall socket. This switches on the mains supply. **The mains cable is inside the battery compartment.**

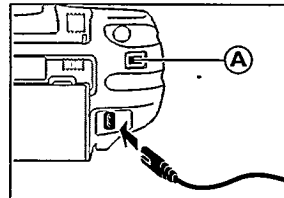

The battery supply will be switched off when the set is connected to the mains. To change over to battery supply, pull out the plug from the unit's AC MAINS socket.

To disconnect the set from the mains completely, remove the mains plug from the wall socket.

## Environmental information

All redundant packing material has been omitted. We have done our utmost to make the packaging easily separable into three mono materials: cardboard (box), polystyrene foam (buffer) and polyethylene (bags, protective foam sheet).

*Your set consists of materials which can be recycled if disassembled by a specialized company. Please observe the local regulations regarding the disposal of packing materials, exhausted batteries and old equipment.*

## Switching the set on and off

Set the POWER slider to the desired sound source: CD, TAPE, or BAND (for radio).

The set is switched off when the POWER slider is set to OFF/TAPE and the keys of the tape deck are released.

*Note: If you use batteries, switch the set off after use. This will avoid unnecessary power consumption.*

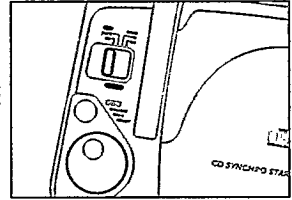

## Adjusting volume and sound

Adjust the volume using the VOLUME control.

Increase and decrease the bass level by pressing DBB.

The bass level can also be emphasised if you place the set against wall or shelf. Do not cover any vents; leave sufficient room around the unit for ventilation.

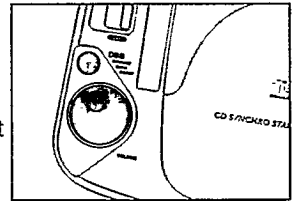

## Radio – tuning to radio stations

**1** Set the POWER slider to FM or MW to select the desired wave band.

**2** Tune to the desired radio station by using the TUNING wheel.

### Improving RADIO reception

For **FM** stations, pull out the telescopic antenna. To improve the signal, incline and turn the antenna. Reduce its length if the signal is too strong (very close to a transmitter).

For **MW** stations, direct the built-in antenna by turning the whole set. The telescopic antenna is not needed.

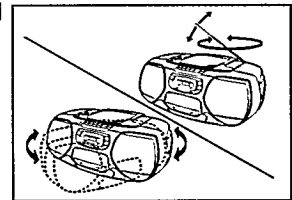
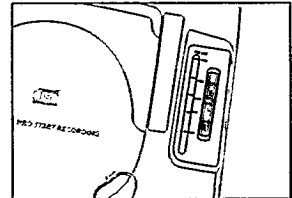

## Playing a CD

- 1 Set the POWER slider to CD.
- 2 Press  $\triangle$  OPEN to open the CD compartment.
- 3 Insert an audio CD (printed side up) and close the CD compartment.
  - The CD player starts and scans the contents list of the CD. Then, the CD player stops. Display indication: the total number of tracks.
- 4 Press the  $\triangleright$  button to start CD play.
  - Display indication: the current track number.
- 5 Press the  $\square$  button to stop CD play.
  - Display indication: the total number of tracks.

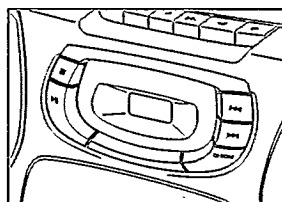
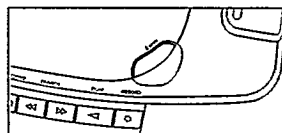

You can interrupt CD play by pressing  $\triangleright$ . Continue CD play by pressing the button again.

- Display indication: the current track number (flashing).

*Note: CD play will also stop if:*

- you open the CD compartment,
- the end of the CD is reached, or
- you move the POWER slider.

If you make a mistake when operating the CD player, or if the CD player cannot read the CD, the display shows *E* or *no*. (See "TROUBLESHOOTING".)

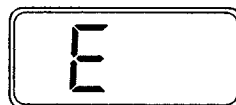

If you press  $\triangleright$  and there is no CD inserted, the display shows *no*.

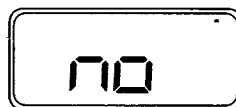

# CD PLAYER

English

## Search backward ◀◀ and forward ▶▶

### Selecting another track

Briefly press the ◀◀ or ▶▶ button once/several times to skip to the beginning of the current, previous or subsequent track(s).

*During CD play:*

CD play continues automatically with the selected track.

*When CD play is stopped:*

Press ▶▶ to start CD play.

→ Display indication: the selected track number.

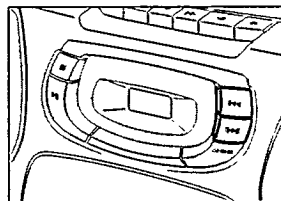

### Searching for a passage during CD play

1 Hold down the ◀◀ or ▶▶ button to find a particular passage in a forward or backward direction.

→ CD play continues at a low volume.

2 Release the button when you have reached the desired passage.

*Note: In the different CD modes or when playing a program, searching is only possible within the particular track.*

## CD MODE: Shuffle and Repeat

1 During CD play press CD MODE repeatedly to cause the display to show the different playing modes.

- **SHUFFLE:** All tracks of the CD (or program) are played in random order.
- **SHUFFLE REPEAT ALL:** All tracks of the CD (or program) are played repeatedly in random order.
- **REPEAT:** The current track is played repeatedly.
- **REPEAT ALL:** The entire CD (or program) is played repeatedly.

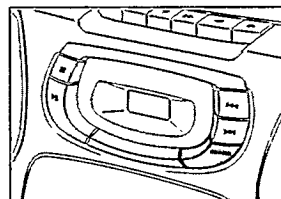

2 After 2 seconds of flashing display indication, CD play starts in the chosen mode.

3 To return to normal CD play, press CD MODE until the display indication disappears.





## CD MODE: Programming track numbers

You can select a number of tracks and store these in the memory in the desired sequence. You can store any track more than once. A maximum of 20 tracks can be stored in the memory.

- 1 When CD play is stopped, select the desired track with ◀◀ or ▶▶.
- 2 As soon as the number of the desired track is displayed, press CD MODE to store the track in the memory.  
→ PROGRAM appears on the display. P lights up briefly, then the number of the stored track is shown.
- 3 Select and store all desired tracks in this way.
- 4 You can review your settings by pressing and holding CD MODE for more than 1 second.  
→ The display shows all stored track numbers in sequence.

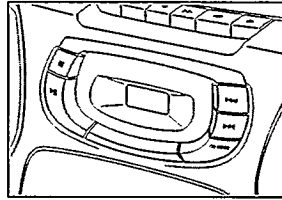

If you try to store more than 20 tracks, the display shows F.

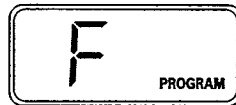

## Playing the program

Press ▶▶ to play the program.



## Erasing the program

From the stop position, press □.

- no lights up briefly, PROGRAM disappears and your program is erased.



*Note: The program will also be erased if you:*

- interrupt the power supply,
- open the CD compartment, or
- move the POWER slider.

# CASSETTE RECORDER

English

## Playing a cassette

- 1 Set the POWER slider to TAPE.
- 2 Press STOP-OPEN  $\square \triangle$  to open the cassette compartment.
- 3 Insert a recorded cassette with the open side upwards and close the cassette compartment.
- 4 Press PLAY  $\triangleleft$  to start playback.
- 5 Press  $\gg$  or  $\ll$  to rewind or fast forward the tape.
- 6 To stop the tape press STOP-OPEN  $\square \triangle$ .

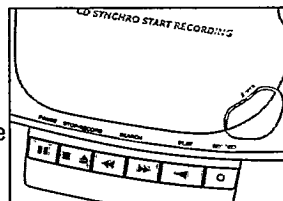

*Note: The keys are released at the end of the tape.*

## General information on recording

Recording is permissible insofar as copyright or other rights of third parties are not infringed upon.

For recording on this set you should use a cassette of the type NORMAL (IEC type I). This deck is not suitable for recording on cassettes of the type CHROME (IEC type II) or METAL (IEC type IV).

The recording level is set automatically. The controls VOLUME and DBB do not affect the recording.

At the very beginning and end of the tape, no recording will take place in the 7 seconds during which the leader tape passes the recorder heads.

### Protecting tapes from accidental erasure

Keep the cassette side to be protected in front of you and snap off the left tab. Now, recording on this side is no longer possible.

To record again on this side of the cassette, cover the opening with a piece of adhesive tape.

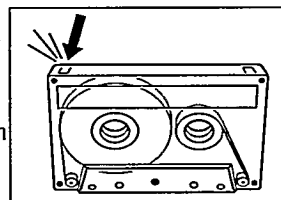

## Recording from the CD player – CD synchro start

- 1 Set the POWER slider to CD.
- 2 Insert a CD and, if desired, program the track numbers.
- 3 Press STOP-OPEN □ ▲ to open the cassette compartment.
- 4 Insert a blank, unprotected, cassette and close the cassette compartment.
- 5 Press RECORD ○ to start recording.  
→ Playing of the CD or program starts automatically.
- 6 For brief interruptions press PAUSE ⏸. Press the PAUSE ⏸ key again to resume recording.
- 7 To stop recording, press STOP-OPEN □ ▲.

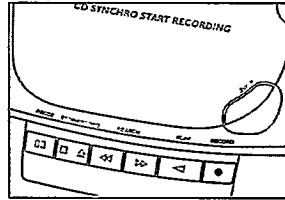

*Note: the recording can be started from different positions:*  
– if the CD player is in pause mode, recording will start from this very position (use ◀ or ▶);  
– if the CD player is in stop mode, recording will start from the beginning of the CD or program.

## Recording from the radio

- 1 Tune to the desired radio station (see "RADIO").
- 2 Press STOP-OPEN □ ▲ to open the cassette compartment.
- 3 Insert a blank, unprotected, cassette and close the cassette compartment.
- 4 Press RECORD ○ to start recording.
- 5 For brief interruptions press PAUSE ⏸. To resume recording press the PAUSE ⏸ key again.
- 6 To stop recording, press STOP-OPEN □ ▲.

# GENERAL INFORMATION

English

## General maintenance

Do not expose the set, batteries, CDs, or tapes to humidity, rain, sand, or excessive heat (caused by heating equipment or direct sunlight).

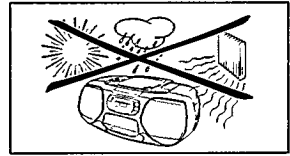

The mechanical parts of the set contain self-lubricating bearings and must not be oiled or lubricated!

You can clean the set with a soft, slightly dampened, lint-free cloth. Do not use any cleaning agents as they may have a corrosive effect.



## Tape deck maintenance

To ensure proper recording and playback quality, clean parts (A), (B) and (C) after approximately 50 hours of operation. Use a cotton swab slightly moistened with alcohol or head-cleaner fluid.

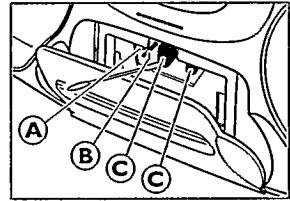

Press PLAY ◀ and clean the rubber pressure roller (A).

Press PAUSE ⏸ and clean the capstan (B) and the heads (C).

*Note: Cleaning of the heads (C) can also be done by playing a cleaning tape once.*

## CD player and CD handling

The lens (X) of the CD player should never be touched. Always keep the CD compartment closed to avoid dust on the lens.

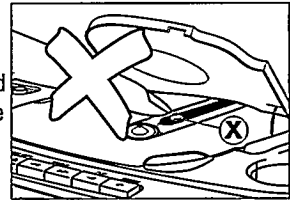

The lens may cloud over when the set is suddenly moved from cold to warm surroundings. Playing a CD is not possible then. Leave the CD player in a warm environment until the moisture evaporates.

To take the CD out of its box easily, press the centre spindle while lifting the CD. Always pick up the CD by the edge and put it back in its box after use.



To clean the CD, wipe it in a straight line from the center toward the edge using a soft, lint-free cloth. A cleaning agent may damage the disc!

Never write on a CD or attach a sticker to it.

# TROUBLESHOOTING

English

## WARNING

***Under no circumstance should you try to repair the set yourself as this will invalidate the guarantee.***

If a fault occurs, first check the points listed below before taking the set for repair.

If you are unable to solve a problem by following these hints, consult your dealer or service center.

<b>Problem</b>	<b>Possible cause</b>	<b>Solution</b>
<b>No sound, no power</b>	VOLUME is not adjusted.	Adjust volume.
	Headphones are connected.	Disconnect headphones.
	Mains cable is not securely connected.	Connect mains cable properly.
	Batteries are flat.	Insert fresh batteries.
	Batteries are inserted incorrectly.	Insert batteries correctly.
	Trying to change over from mains to battery supply without removing the plug.	Remove the mains plug from the unit's AC MAINS socket.
<b>No reaction to operation of any keys</b>	Electrostatic discharge.	Disconnect the set from power supply, reconnect after a few seconds.
<b>Poor radio reception</b>	Weak radio signal.	Direct the antenna for optimum reception.
	Interference caused by electrical equipment like TVs, computers, engines, etc.	Keep the radio away from electrical equipment.
<b>no or E indication</b>	The CD is badly scratched or dirty.	Replace or clean the CD.
	No CD is inserted.	Insert a CD.
	The CD is inserted upside down.	Insert CD with label facing up.
	The laser lens is steamed up.	Wait until the lens has cleared.
<b>The CD skips tracks</b>	The CD is damaged or dirty.	Replace or clean the CD.
	SHUFFLE or PROGRAM is active.	Switch off SHUFFLE or PROGRAM.
<b>Poor cassette sound quality</b>	Dust and dirt on the heads, capstans or pressure rollers.	Clean heads, capstans, and pressure rollers.
	Use of unsuitable cassette types (METAL or CHROME) for recording.	Only use NORMAL type cassettes for recording.
<b>Recording does not work</b>	Cassette tab(s) may be snapped off.	Apply a piece of adhesive tape over the opening.

English

Русский

Polski

Česky

Slovensky

Magyar

**Meet Philips at the Internet**  
**<http://www.philips.com>**

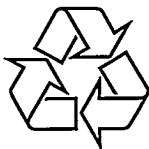

**CLASS 1**  
**LASER PRODUCT**