

PHILIPS

AZ 1008

CD Radio
Cassette Recorder



Let's make things better



PHILIPS

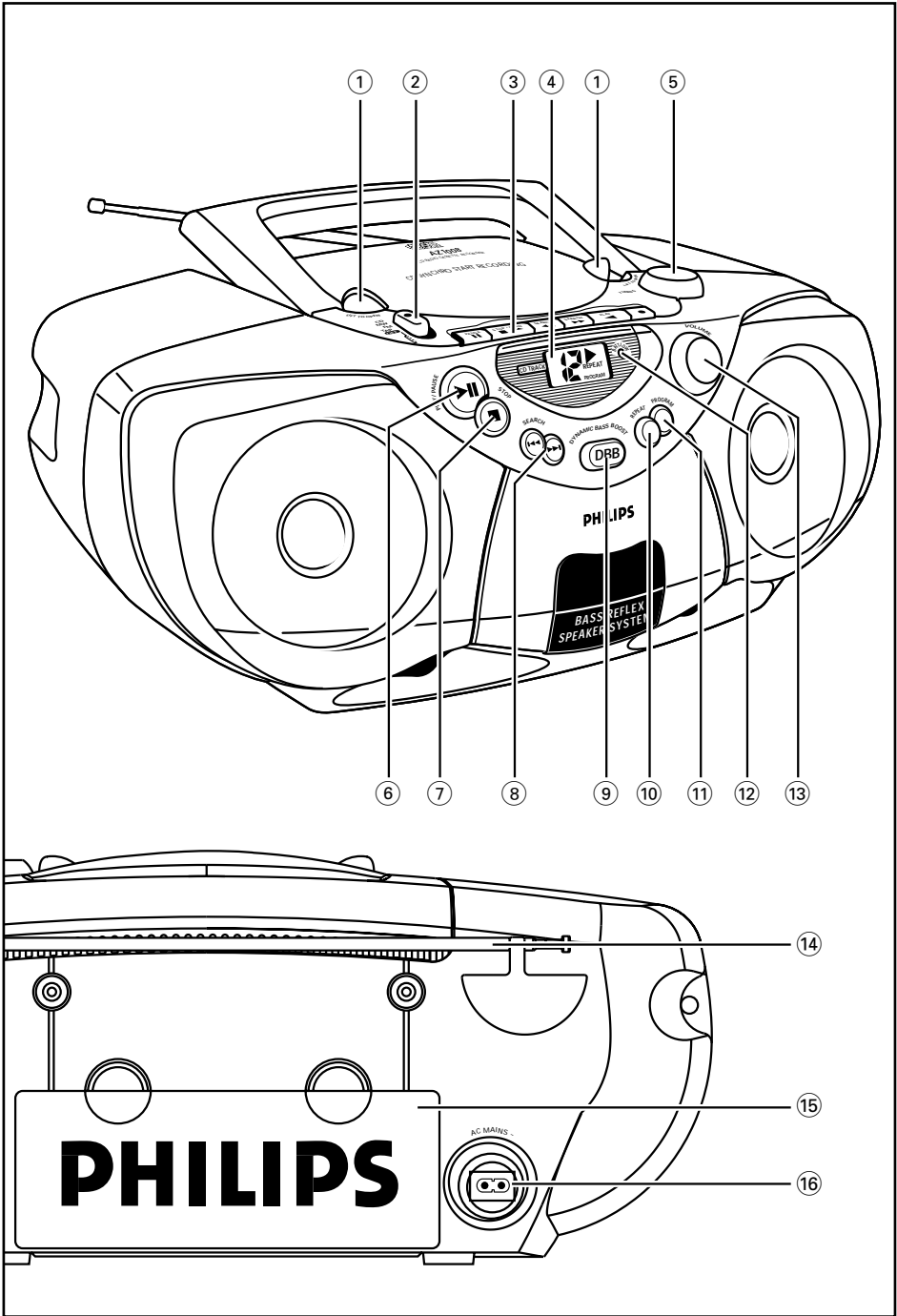

Top and front panels

- 1 **LIFT TO OPEN** – opens/ closes the CD door
- 2 **Source selector: CD, MW, FM, TAPE/OFF**
– selects CD source of sound, tuner waveband or tape source of sound
– power on/ off switch
- 3 **CASSETTE RECORDER:**
PAUSE II – pauses recording or playback
STOP•OPEN ■▲ – stops the tape; opens the cassette door
SEARCH ◀◀ or ▶▶ – fast rewinds / winds the tape
PLAY ◀ – starts playback
RECORD ● – starts recording
- 4 **CD display** – shows the CD functions
- 5 **TUNING**
- 6 **PLAY•PAUSE ▶▶ II** – starts or pauses CD playback
- 7 **STOP ■** – stops CD playback; erases a CD programme
- 8 **SEARCH ◀◀ , ▶▶**
CD: skips or searches a passage/track backwards or forward
- 9 **DBB (Dynamic Bass Boost)** – enhances bass response
- 10 **REPEAT** – repeats a track/CD/ programme
- 11 **PROGRAM** – programmes and reviews programmed track numbers;
- 12 **BATT LOW** – indicator lights up if battery power running low
- 13 **VOLUME** – adjusts volume level

Back Panel

- 14 **Telescopic aerial** – to improve FM reception
- 15 **Battery door** – open to insert 6 x 1.5V R14/UM2/ C-cell batteries
- 16 **AC MAINS** – inlet for mains lead

Power Supply

Whenever convenient, use the power supply if you want to conserve battery life.

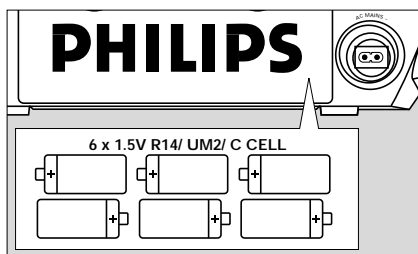

Make sure you remove the plug from the set and wall socket before inserting batteries.

For users in the U.K.: please follow the instructions on page 2.

Batteries (not included)

- 1 Open the battery compartment and insert six batteries, type **R-14**, **UM-2** or **C-cells**, (preferably alkaline) with the correct polarity as indicated by the "+" and "-" symbols inside the compartment.
- 2 Close the compartment door, and make sure the batteries are firmly and correctly in place. The set is now ready to operate.
→ If **BATT LOW** lights up, battery power is running low. The BATT LOW indicator eventually goes out if the batteries are too weak.

Batteries contain chemical substances, so they should be disposed of properly.

Incorrect use of batteries can cause electrolyte leakage and will corrode the compartment or cause the batteries to burst. Therefore:

- Do not mix battery types: e.g. alkaline with carbon zinc. Only use batteries of the same type for the set.
- When inserting new batteries, do not try to mix old batteries with the new ones.
- Remove the batteries if the set is not to be used for a long time.

Using AC Mains

- 1 Check if the mains voltage, **as shown on the type plate located on the bottom of the set**, corresponds to your local mains supply. If it does not, consult your dealer or service centre.

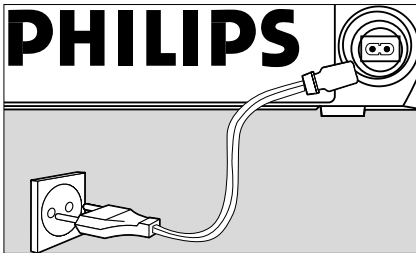

- 2 Connect the mains lead to the AC MAINS inlet and the wall socket. The mains supply is now connected and ready for use.
 - 3 To switch off completely, unplug the mains lead from the wall socket.
- Unplug the mains lead from the wall socket to protect your set during heavy thunderstorms.

The type plate is located on the bottom of the set.

Switching power on/off: Save energy

Whether you are using mains or battery supply, to avoid unnecessary energy consumption always adjust the source selector to **TAPE/OFF** and check if the cassette keys are released.

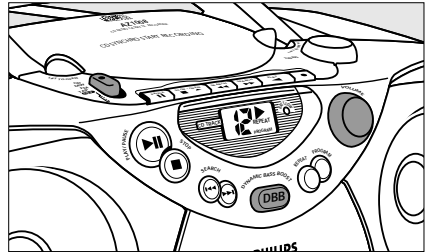

General operation

- 1 To select your sound source adjust the source selector to **CD, MW, FM** or **TAPE/OFF**.
- 2 Adjust the sound with the **VOLUME** and **DBB** (Dynamic Bass Boost) controls.
- 3 To switch off the set, adjust the source selector to **TAPE/OFF** position and check the cassette keys are released.

Environmental information

All unnecessary packaging material has been omitted. The packaging can be easily separated into three materials: cardboard, polystyrene and plastic.

Your set consists of materials which can be recycled if disassembled by a specialized company. Please observe the local regulations regarding the disposal of packing materials, exhausted batteries and old equipment.

Radio reception

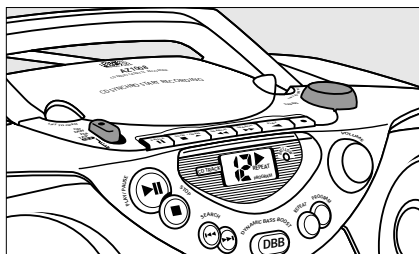

- 1 Adjust the source selector to **MW** or **FM** to select your desired waveband.
- 2 Turn **TUNING** to tune to a radio station.

To improve reception

– For **FM**, pull out the telescopic aerial. Incline and turn the aerial. Reduce its length if the signal is too strong (very close to a transmitter).

– For **MW** the set is provided with a built-in aerial so the telescopic aerial is not needed. Direct the aerial by turning the whole set.

- 3 To switch off the radio, adjust the source selector to **TAPE/OFF** position and check the cassette keys are released.

CD Player

Display indication for CD functions:

- - - : flashes when CD source just selected
- **In stop mode**: total track number
- **During CD playback**: ► and current track number

REPEAT/ REPEAT ALL: when the respective repeat mode is activated

– **PROGRAM**: when CD programme active

– - - and **PROGRAM**: flashes when programme memory full

– **ER**: no disc/ error in CD operation or with the CD/ CD-(R) is blank or the disc is not finalised (see Troubleshooting)

Playing a CD

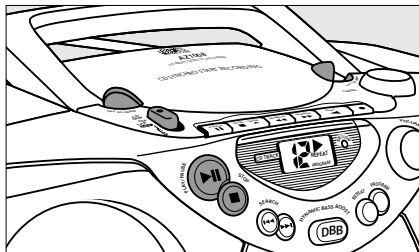

- 1 Adjust the **source selector** to CD.
- 2 To open the CD door, lift the CD door at the edge marked **LIFT TO OPEN**.
- 3 Insert a CD or CD-(R) with the printed side facing up and press the CD door gently close.
- 4 Press **PLAY-PAUSE ►||** on the set to start playback.
- 5 To pause playback press **PLAY-PAUSE ►||**. To resume, press **PLAY-PAUSE ►||** again.
→► flashes during pause
- 6 To stop CD play, press **STOP ■**.
- 7 To switch off the set, adjust the source selector to **TAPE/OFF** position and check the cassette keys are released.

Note: CD play will also stop when:

- you open the CD compartment;
- you select **MW, FM** or **TAPE** sound source;
- the CD has reached to the end.

Selecting a different track

During playback you can use the **SEARCH** buttons to select a particular track.

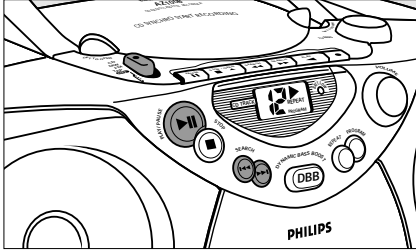

- If you have selected a track number in the stop or pause position, press **PLAY•PAUSE** **▶▶** to start playback.
- Press **SEARCH** **▶▶** once briefly for the next track, or press repeatedly until the desired track number appears in the display.
- Press **SEARCH** **◀◀** once briefly to return to the beginning of a current track.
- Press **SEARCH** **◀◀** more than once briefly for a previous track.

Finding a passage within a track

- 1 During playback, press and hold down **SEARCH** **◀◀** or **▶▶**.
 - The CD is played at high speed and low volume.
- 2 When you recognize the passage you want release the **SEARCH** button.
 - Normal playback resumes.

Note: When searching within a final track and you reach the end of the last track, the CD goes to stop mode.

Repeat play modes

REPEAT can be selected or changed during playback in the following sequence:

REPEAT – plays the current track continuously

REPEAT ALL – plays the entire CD continuously

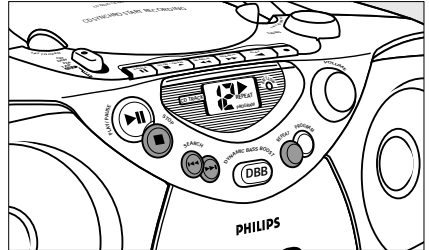

- 1 During playback, press **REPEAT** once or more until the desired REPEAT mode is shown.
 - You can use **SEARCH** **◀◀** or **▶▶** to skip tracks during the repeat modes.
 - The **REPEAT** play options can be combined and used with a programme: e.g. **REPEAT ALL PROGRAM**– repeats the entire CD programme.
- 2 To return to normal playback press **REPEAT** until the REPEAT modes are no longer shown.
 - You can also press **STOP** **■** to quit the play mode.

Programming track numbers

You may store up to 19 tracks in the desired sequence. If you like, store any track more than once.

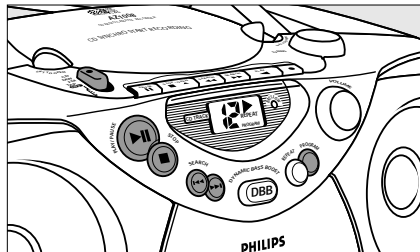

- 1 In the STOP mode, press **PROGRAM** to activate programme mode.
→ **00** and **PROGRAM** flashes.
- 2 Press **SEARCH** **◀** or **▶** for your desired track.
→ Your selected track number and **PROGRAM** flashes.
- 3 Press **PROGRAM** to store the track.
→ **00** and **PROGRAM** flashes, ready for your next track selection.
- 4 Repeat steps **2** to **3** to select and store all desired tracks in this way.
→ **--** and **PROGRAM** flashes in the display if you attempt to programme more than 19 tracks.
- 5 To play your programme, press **PLAY•PAUSE** **▶||**.

Reviewing your programme

- In the STOP mode, press **PROGRAM** repeatedly to see your stored track numbers.

Erasing a programme

You can erase the contents of the memory by:

- opening the CD door;
- selecting **MW, FM** or **TAPE** sound source;
- pressing **STOP** **■** (twice during playback or once in the stop position.)
→ Display: **PROGRAM** disappears.

CASSETTE RECORDER

Cassette playback

- 1 Adjust the source selector to **TAPE/OFF**.
- 2 Press **STOP•OPEN** **■▲** to open the cassette door and insert a recorded cassette.

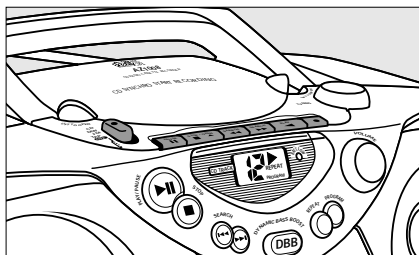

- 3 Close the cassette door.
- 4 Press **PLAY** **◀** to start playback.
- 5 To pause playback press **PAUSE** **||**. To resume, press the key again.
- 6 By pressing **SEARCH** **◀** or **▶**, fast winding of the tape is possible in both directions. To stop fast winding, press **STOP•OPEN** **■▲**.
- 7 To stop the tape, press **STOP•OPEN** **■▲**.
 - The keys are automatically released at the end of the tape, and the set is switched off, except if **PAUSE** **||** has been activated.

General information on recording

- Recording is permissible insofar as copyright or other rights of third parties are not infringed.
- This deck is not suited for recording on CHROME (IEC II) or METAL (IEC IV) type cassettes. For recording, use only NORMAL type cassettes (IEC type I) on which the tabs have not been broken.
- *The best recording level is set automatically.* Altering the **VOLUME** and **DBB** controls will not affect the recording in progress.
- At the very beginning and end of the tape, no recording will take place during the 7 seconds when the leader tape passes the recorder heads.
- To protect a tape from accidental erasure, have the tape in front of you and break out the left tab. Recording on this side is no longer possible. To record over this side again, cover the tabs with a piece of adhesive tape.

Synchro Start CD recording

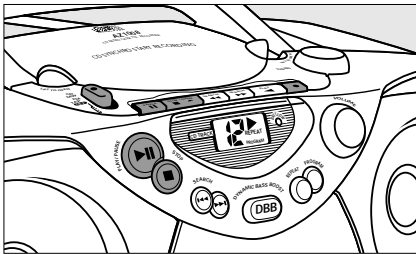

- 1 Select CD source.
- 2 Insert a CD and if desired, programme track numbers.
- 3 Press **STOP•OPEN** ■▲ to open the cassette door. Insert a blank tape.
- 4 Close the cassette door.

- 5 Press **RECORD** ● to start recording.
- Playing of the CD programme starts automatically from the beginning of the programme. *It is not necessary to start the CD player separately.*
- 6 For brief interruptions press **PAUSE** II. To resume recording, press **PAUSE** II again.
- 7 To stop recording, press **STOP•OPEN** ■▲. → The CD player goes to pause mode. Press **PLAY•PAUSE** ►II to resume CD playback, or press **STOP** ■ to stop CD play.

Selecting and recording a particular passage

- During CD playback, press and hold down the **SEARCH** buttons ◀◀ or ▶▶ on the set to find your passage.
- Press **PLAY•PAUSE** ►II to put the CD player on pause at the selected passage. → Recording will begin from this exact point in the track when you press **RECORD** ●.

*Note: If you press **RECORD** ● during playback, recording starts automatically from the beginning of the current track.*

Recording from the Radio

- 1 Adjust the source selector to MW or FM to select your desired waveband.
- 2 Tune to the desired radio station (see **Radio reception**).
- 3 Press **STOP•OPEN** ■▲ to open the cassette door. Insert a blank tape.
- 4 Close the cassette door.
- 5 Press **RECORD** ● to start recording.
- 6 For brief interruptions, press **PAUSE** II. To resume recording, press **PAUSE** II again.
- 7 To stop recording, press **STOP•OPEN** ■▲.

Maintenance

Precautions & General Maintenance

- Place the set on a hard and flat surface so that the system does not tilt.
- Do not expose the set, batteries, CDs or cassettes to humidity, rain, sand or excessive heat caused by heating equipment or direct sunlight.
- Do not cover the set. Adequate ventilation with a minimum gap of 6 inches between the ventilation holes and surrounding surfaces is necessary to prevent heat build-up.
- The mechanical parts of the set contain self-lubricating bearings and must not be oiled or lubricated.
- To clean the set, use a soft, slightly dampened chamois leather. Do not use any cleaning agents containing alcohol, ammonia, benzene or abrasives as these may harm the housing.

Tape deck maintenance

To ensure quality recording and playback of the tape deck, clean parts (A), (B) and (C) shown in the diagram below, after approx. 50 hours of operation, or on average once a month. Use a cotton bud slightly moistened with alcohol or a special head cleaning fluid to clean the deck.

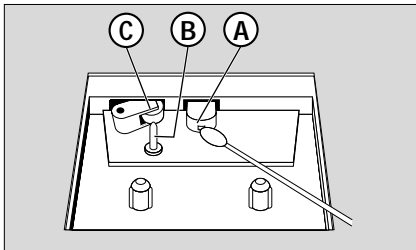

- 1 Open the cassette door by pressing **STOP•OPEN** ■▲

- 2 Press **PLAY** ◀ and clean the rubber pressure roller (C).
- 3 Press **PAUSE** ■■ and clean the magnetic heads (A), and also the capstan (B).
- 4 After cleaning, press **STOP•OPEN** ■▲.
 - Cleaning of the heads can also be done by playing a cleaning cassette through once.

CD player and CD handling

- The lens of the CD player should never be touched!
- Sudden changes in the surrounding temperature can cause condensation to form and the lens of your CD player to cloud over. Playing a CD is then not possible. Do not attempt to clean the lens but leave the set in a warm environment until the moisture evaporates.
- Use only Digital Audio CDs.
- Always close the CD door to keep the CD compartment dust-free. To clean, dust the compartment with a soft dry cloth.
- To take a CD out of its box, press the centre spindle while lifting the CD. Always pick up the CD by the edge and replace the CD back in its box after use to avoid scratching and dust.
- To clean the CD, wipe in a straight line from the centre towards the edge using a soft, lint-free cloth. Do not use cleaning agents as they may damage the disc.
- Never write on a CD or attach any stickers to it.

If a fault occurs, first check the points listed below before taking the set for repair. Do not open the set as there is a risk of electric shock.

If you are unable to remedy a problem by following these hints, consult your dealer or service centre.

WARNING: *Under no circumstances should you try to repair the set yourself, as this will invalidate the guarantee.*

Problem	Solution
No sound	– Adjust the VOLUME
No power	– Mains lead not securely connected. Connect AC mains lead properly – Batteries exhausted /incorrectly inserted. Insert (fresh) batteries correctly
Display does not function properly/ No reaction to operation of any of the controls	– Electrostatic discharge Switch off and unplug the set. Reconnect after a few seconds.
⊘ indication	– No CD inserted, insert a CD – CD badly scratched/ dirty. Replace/ clean CD (see maintenance) – CD-(R) is blank or the disc is not finalized. Use a finalized CD-(R) – Laser lens steamed up. Wait until lens has cleared/acclimatized
CD playback does not work	– CD badly scratched/ dirty. Replace/ clean CD (see maintenance)
The CD skips tracks	– CD damaged or dirty. Replace or clean CD. – Programme is active. Quit programme mode
Poor cassette sound quality	– Dust and dirt on the heads, etc. Clean deck parts, see maintenance. – Use of incompatible cassette types (METAL or CHROME). Only use NORMAL (IEC I) for recording
Recording does not work	– Cassette tab(s) may be broken. Apply a piece of adhesive tape over the missing tab space.