

# PHILIPS

AW 7850 Stereo Radio Cassette Recorder

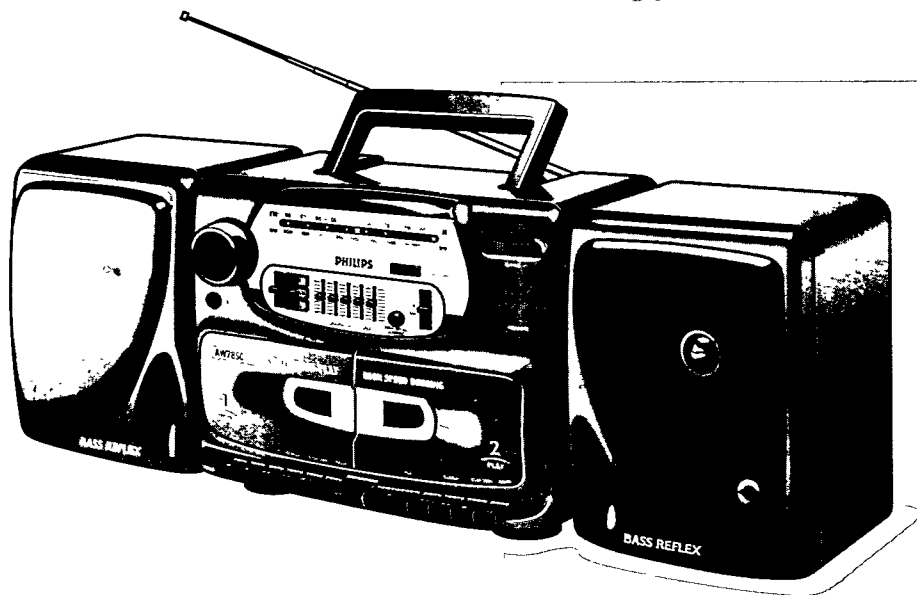

Instructions for use  
Mode d'emploi  
Instrucciones de manejo  
Manual de utilização  
使用説明書



**PHILIPS**

English .....4

Français ..... 10

Español..... 16

Brasileiro .....22

中文 .....28

English

Français

Español

Brasileiro

中文

**México**



Es necesario que lea cuidadosamente su instructivo de manejo.

	<b>PRECAUCIÓN - ADVERTENCIA</b> No abrir, riesgo de choque eléctrico	
	<b>ATENCIÓN</b> Verifique que el voltaje de alimentación sea el requerido para su aparato	
Para evitar el riesgo de choque eléctrico, no quite la tapa. En caso de requerir servicio, diríjase al personal calificado.		

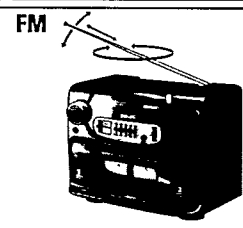
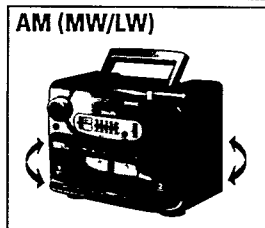
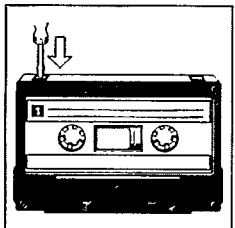
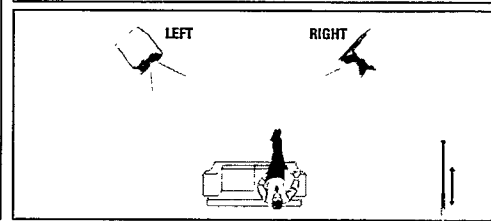
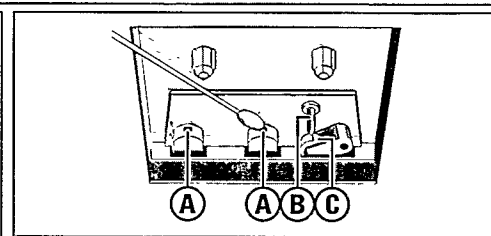
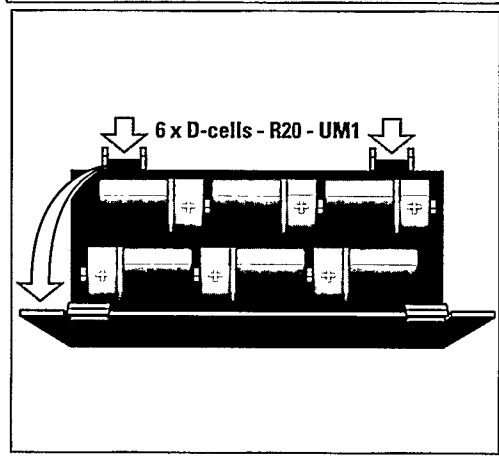
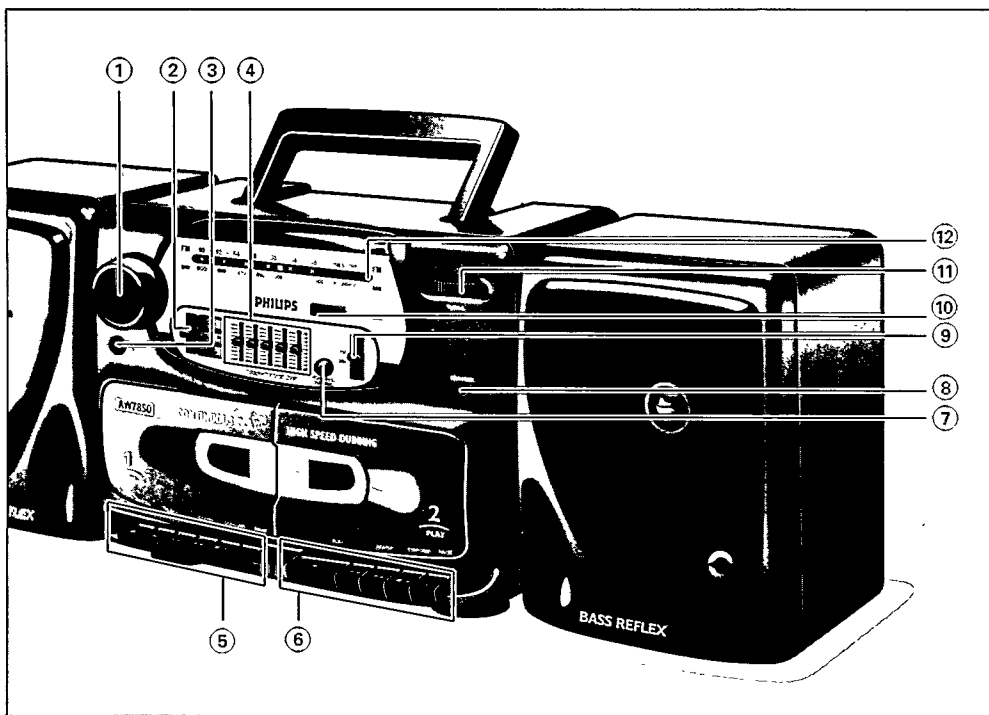

# CONTROLS

English

## Front panel

- ① **VOLUME** – to adjust the volume level
- ② **MODE** selector – to select the sound source  
– **RADIO**  
– **TAPE / RADIO OFF**
- ③  – 3.5 mm stereo headphone socket
- ④ **GRAPHIC EQUALIZER** – to adjust the range of sound
- ⑤ **DECK 1:**  
**RECORD ●:** to start recording  
**PLAY ►:** to start playback  
**SEARCH ◀◀/▶▶:** to fast wind/rewind  
**STOP • OPEN ■ ▲:** to stop the tape / to open the cassette compartment  
**PAUSE II:** to interrupt recording or playback
- ⑥ **DECK 2:**  
**PLAY ►:** to start playback  
**SEARCH ◀◀/▶▶:** to fast wind/rewind  
**STOP • OPEN ■ ▲:** to stop the tape / to open the cassette compartment  
**PAUSE II:** to interrupt recording or playback
- ⑦ **HIGH SPEED DUBBING** – to dub a cassette at high speed
- ⑧ **KARAOKE** – 3.5 mm stereo socket for microphone
- ⑨ **BAND** – to select the wave bands (SW and LW bands not on all versions)
- ⑩ **FINE TUNING** – to tune to short wave bands (for SW version only)
- ⑪ **TUNING** – to tune to radio stations
- ⑫ **FM STEREO** indicator – lights up when receiving a FM stereo station

## Back panel

- ⑬ **Telescopic aerial**
- ⑭ **Beat Cut** switch – to eliminate any whistle tones during AM recordings
- ⑮ **Speakers** – speaker sockets
- ⑯ **Speaker levers** – to lock and unlock the speaker boxes
- ⑰ **MAINS** – socket for mains lead
- ⑱ **Voltage selector** – (not on all versions)
- ⑲ **Battery door** – to open the battery compartment

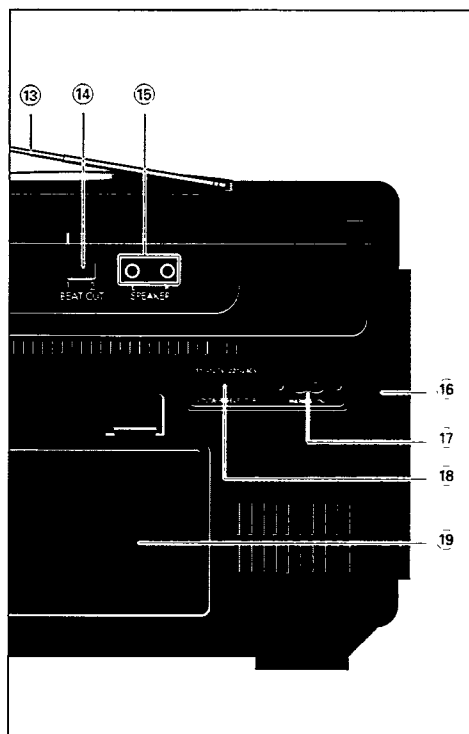

## POWER SUPPLY

### Batteries (optional)

Whenever convenient, use mains supply to conserve battery life.

1. Open the battery compartment and insert six batteries, type R20, UM1 or D-cells (preferably alkaline), with the correct polarity as indicated by the '+' and '-' symbols inside the compartment.
2. Replace the compartment door, making sure that the batteries are firmly and correctly in place. The set is now ready to operate.
  - The battery supply is switched off when the set is connected to the mains. To change over to battery supply, pull out the plug from the MAINS socket.

Incorrect use of batteries can cause electrolyte leakage and will corrode the compartment or cause the batteries to burst. Therefore:

- Don't mix battery types.
- When inserting new batteries replace six batteries at the same time. Do not try to mix old batteries with the new ones.
- Remove the batteries if they are empty or when the set will not be used again for a long time.

### Mains supply

- Check if the mains voltage, as shown on the model number plate (on the base of the set) corresponds to your local mains voltage. If it does not, consult your dealer or service centre.
- If the set is equipped with a voltage selector, set the selector to the local mains voltage.
- Connect the mains lead to the MAINS socket and the wall socket. The mains supply is switched on.
- The battery supply is switched off when the set is connected to the mains. To change over to battery supply, pull out the plug from the set's MAINS socket.
- To disconnect the set from the mains completely, withdraw the mains plug from the mains socket.

*The model and production number are located at the bottom of the set.*

## CONNECTIONS

### Removable speakers

#### Connecting the loudspeakers

- Connect the right loudspeaker to the R terminal and the left loudspeaker to the L terminal.

**Note:** Loudspeakers other than supplied can be used. They have to be 4 Ohms or higher. Do **NOT** use loudspeakers with an impedance lower than 4 Ohms, as this will damage the set.

#### Taking off the loudspeakers

- Keep the lever (on the back of the loudspeakers) pressed and slide the loudspeaker upwards.

#### Attaching the loudspeakers

- Slide the loudspeakers from above in the sleeves on the sides of the set cabinet. The loudspeakers will click into position.

#### Positioning the loudspeakers

- You will find the best loudspeaker position by experimenting. Placing the loudspeakers on the floor will increase the bass response. Placing the loudspeakers behind curtains, furniture etc. will reduce the treble response and the stereo effect. The ideal position is obtained when the 2 front loudspeakers and the listening position build an equilateral triangle and the loudspeakers are at ear-height.

### Stereo headphone socket

You may connect stereo headphones with a 3.5 mm plug to the  socket. When headphones are inserted, the loudspeakers are then muted.

### Karaoke (mic) socket

For a microphone with a 3.5 mm plug. You can reproduce your voice amplified through the loudspeakers.

- Connect a microphone to the KARAOKE socket. To avoid disturbing noise, reduce the volume before connection.
- Set the mode selector in position TAPE/RADIO OFF.
- Press PLAY ► and PAUSE II of either deck 1 or 2.

You can also mix your voice with the radio or a cassette signal (Karaoke). You can record it all on deck 1. See 'Microphone & Karaoke recording' for details of recording and the mixing functions.

## General operation

- Set the mode selector to the source you want to listen to.
- Adjust the sound using VOLUME and GRAPHIC EQUALIZER controls.  
**GRAPHIC EQUALIZER** controls:  
 100 Hz - bass  
 300 Hz - mid range tones  
 1 KHz - vocals  
 3.0 KHz - brightness of sound  
 10 KHz - treble  
 To adjust the graphic equalizer, set each control towards + 10 or - 10. When the equalizer is not used, set the controls to 0 ( the centre position).
- Set the mode selector to TAPE/RADIO OFF position (with the cassette keys released) to switch off the set.
  - The indicator of your selected mode will go out.

## Radio reception

- Set the mode selector to RADIO.
  - The RADIO indicator lights up.
- Adjust the sound using the VOLUME and GRAPHIC EQUALIZER controls.
- Select the wave band using the band selector. *(SW and LW not on all versions.)*
- Tune to a radio station using the TUNING knob, or FINE TUNING for tuning short wave stations.
  - For FM, pull out the telescopic aerial. To improve FM-reception, incline and turn the aerial. Reduce its length if the FM-signal is too strong (very close to a transmitter).
  - For MW/LW, the set is provided with a built-in aerial, so the telescopic aerial is not needed. Direct the aerial by turning the whole set.
  - For SW1 and SW2, pull out the telescopic aerial and place in the vertical position. Vary the length to improve reception.
- When FM STEREO lights up, you are receiving a FM stereo transmitter.
- To switch off the set, set the mode selector to TAPE / RADIO OFF position.
  - The RADIO indicator will go out.

## Playback on deck 1 or 2

- Set the mode selector to TAPE/RADIO OFF.
- Press STOP • OPEN ■▲ to open the cassette holder.
- Insert a recorded cassette.
- Press PLAY ► to start playback.
  - The TAPE/RADIO OFF indicator lights up.
- Adjust the sound using the VOLUME and GRAPHIC EQUALIZER controls.
- To interrupt playback, press PAUSE ■■. To resume press PAUSE ■■ again.
- For fast winding, press SEARCH ◀◀ or ▶▶
- Press STOP • OPEN ■▲ to stop playback.
  - The TAPE/RADIO OFF indicator will go out.

**Note:** When the end of the tape is reached, the keys are automatically released and the set switched off.

## Continuous playback

- Set the mode selector to TAPE.
- Press both STOP • OPEN ■▲ buttons to open the cassette holders.
- Insert a recorded cassette into both decks.
- Press PLAY ► on deck 2.
  - Deck 2 will start playback.
- Press PAUSE ■■ and then PLAY ► on deck 1.
  - As soon as deck 2 stops (at the end of the cassette or when STOP • OPEN ■▲ is pressed), PAUSE ■■ is released and deck 1 will start playback.
- To stop the tape, press STOP • OPEN ■▲.
  - The TAPE indicator will go out.

# CASSETTE RECORDER

English

## Recording

- Recording is permissible insofar as copyright or other rights of third parties are not infringed.
- Recording is only possible with deck 1. During recording it is advisable not to wind or rewind a cassette in deck 2.
- For recording only use NORMAL type cassettes (IEC type I) on which the tabs are not broken out. This set is NOT suited for recording on CHROME (IEC II) or METAL (IEC IV) type cassettes.
- Before recording, tighten slack tape with a pencil, to avoid jamming the deck mechanism.
- The best recording level is automatically set. Altering the VOLUME and GRAPHIC EQUALIZER controls will not affect the recording in progress.
- At the very beginning and end of the tape, no recording will take place during 7 seconds when the leader passes the recorder heads.
- To prevent the accidental erasure of a recording, keep the cassette side to be safeguarded in front of you and break out the left tab. Now, recording on this side is no longer possible.  
To render this safeguard ineffective, cover the aperture with a piece of adhesive tape.

## Recording from the radio

- Set the mode selector to RADIO.
  - The RADIO indicator will light up.
- Tune to the desired radio station (see 'Radio reception').
- Insert a blank cassette in deck 1.
- Press RECORD ● to start recording.
  - For brief interruptions, press PAUSE II. To resume recording press PAUSE II again.
  - A whistling sound occurring during AM radio recordings can be suppressed by setting the BEAT CUT switch to another position.
- To stop recording, press STOP • OPEN ■ ▲.

## Microphone recording

- Connect the microphone to the KARAOKE socket, with the volume turned down to avoid noise disturbance.
- Set the mode selector to the desired position (TAPE/RADIO OFF or RADIO).
- Insert a blank cassette in deck 1.
- Press RECORD ● to start recording.
  - For brief interruptions, press PAUSE II. To resume recording press PAUSE II again.
- To stop recording, press STOP • OPEN ■ ▲.
  - If you want to monitor your microphone recording, you can insert headphones in the  socket.

## Karaoke

- For recording karaoke, connect the microphone to the KARAOKE socket, with the volume turned down to avoid noise disturbance.
- Press both STOP • OPEN ■ ▲ keys and insert a recorded tape into deck 2 and a suitable tape for recording in deck 1.
- Press PAUSE II and then RECORD ● on deck 1.
- To start recording, press PLAY ► on deck 2. PAUSE II on deck 1 is then released.
- By pressing PAUSE II on deck 1, you can omit undesired passages while deck 2 continues. Press PAUSE II to resume recording.
- Using PAUSE II of deck 2, deck 1 will only record the karaoke signal.
- To stop recording karaoke, press both STOP • OPEN ■ ▲ keys.

## Dubbing – Copying from deck 2 to 1

When copying, it is recommended to use fresh batteries or to connect the set to the mains supply.

- Set the mode selector to TAPE/RADIO OFF. Do not move this selector during dubbing.
- Press HIGH SPEED DUBBING, unless you want to record at normal speed. Do not press this button during dubbing otherwise your recording will be affected!
- Press both STOP • OPEN ■ ▲ keys and insert a recorded tape into deck 2 and a suitable tape for recording in deck 1.
- Press PAUSE II and then RECORD ● on deck 1.
- To start dubbing, press PLAY ► on deck 2. PAUSE II on deck 1 is then released.
- By pressing PAUSE II on deck 1, you can omit undesired passages while deck 2 continues. Press PAUSE II to resume dubbing.
- Using PAUSE II of deck 2, deck 1 will record a blank part.
- To stop dubbing, press both STOP • OPEN ■ ▲ keys.

## General maintenance

- Do not expose the set, batteries or cassettes to humidity, rain, sand or excessive heat caused by heating equipment or direct sunlight.
- The mechanical parts of the set contain self lubricating bearings and must not be oiled or lubricated.
- To clean the set, use a soft, slightly dampened chamois leather. Do not use any cleaning agents and solvents such as thinner, benzene, as they could have a corrosive effect.

## Tape deck maintenance

To ensure a good recording and playback quality, clean the parts (A), (B) and (C) after approx. 50 hours of operation or, on average once a month. Use a cotton bud slightly moistened with alcohol or a special cleaning fluid.

- Open the cassette holder by pressing STOP • OPEN ■ ▲.
- Press PLAY ► and clean the rubber pressure roller (C).
- Press PAUSE II and clean the magnetic heads (A), and also the capstans (B).
- After cleaning, press STOP • OPEN ■ ▲.

**Note:** Cleaning of the heads (A) can also be done by playing a cleaning cassette through once

## Environmental information

All redundant packaging material has been omitted. We have done our utmost to make the packaging easily separable into three mono materials: cardboard (box), expandable polystyrene (buffer) and polyethylene (bags, protective foam sheet).

Your set consists of materials which can be recycled if disassembled by a specialized company. Please observe the local regulations regarding the disposal of packing materials, exhausted batteries and old equipment.



# TROUBLESHOOTING

If a fault occurs, first check the points listed below before taking your set for repair.  
If you are unable to remedy a problem by following hints, consult your dealer or service centre.

**Warning:**

Under no circumstances should you try to repair the set yourself, as this would invalidate the guarantee.

PROBLEM	POSSIBLE CAUSE	REMEDY
<b>No sound / no power</b>	<ul style="list-style-type: none"> <li>- Volume not adjusted</li> <li>- Headphones are connected</li> <li>- Mains lead not securely connected</li> <li>- Batteries exhausted</li> <li>- Batteries incorrectly inserted</li> <li>- Batteries loaded but mains lead still connected</li> </ul>	<ul style="list-style-type: none"> <li>• Adjust the volume</li> <li>• Disconnect headphones</li> <li>• Connect the mains lead properly</li> <li>• Insert new batteries</li> <li>• Insert the batteries correctly</li> <li>• Pull out the mains plug from the wall socket and the set</li> </ul>
<b>Severe radio hum or noise</b>	<ul style="list-style-type: none"> <li>- Set too close to TV, VCR or computer</li> </ul>	<ul style="list-style-type: none"> <li>• Increase the distance</li> </ul>
<b>Poor radio reception</b>	<ul style="list-style-type: none"> <li>- Weak radio aerial signal</li> </ul>	<ul style="list-style-type: none"> <li>• FM: aim the aerial for the best reception;</li> <li>• AM: rotate the entire set</li> </ul>
<b>Reversed left and right sound / no sound from one speaker</b>	<ul style="list-style-type: none"> <li>- Loudspeakers incorrectly connected</li> </ul>	<ul style="list-style-type: none"> <li>• Connect speakers properly, L to left, R to right</li> </ul>
<b>Bad sound</b>	<ul style="list-style-type: none"> <li>- Unsuitable speakers are used</li> </ul>	<ul style="list-style-type: none"> <li>• Use recommended speakers, impedance 4 Ohms</li> </ul>
<b>Poor cassette sound quality</b>	<ul style="list-style-type: none"> <li>- Dust and dirt on the heads, capstan or pressure roller</li> <li>- Use of incompatible cassette types (METAL or CHROME)</li> </ul>	<ul style="list-style-type: none"> <li>• Clean the heads etc., see Tape deck maintenance</li> <li>• Only use NORMAL (EIC I) for recording</li> </ul>
<b>Recording does not work</b>	<ul style="list-style-type: none"> <li>- Cassette tab(s) may be broken out</li> </ul>	<ul style="list-style-type: none"> <li>• Apply a piece of adhesive tape over the missing tab space</li> </ul>

# AUSTRALIA

## Philips product warranty for Australia

Warranty conditions valid for Colour Television, Video Cassette Recorders, Audio Systems, and Portable Audio.

The benefits given to the purchaser by this warranty are in addition to all other rights and remedies which the purchaser has in respect of the product under the Trade Practices Act or other Commonwealth or State Law.

Philips Sound and Vision warrants its products to the purchaser as follows and subject to the stated conditions.

### 12 months free service

Any defect in materials or workmanship in the product occurring within 12 months from the original date of purchase will be rectified free of charge by Philips Service or one of our authorised service centers.

### Conditions of warranty

1. All claims for warranty service should be made to your nearest Philips Service Branch or to a Philips authorised service dealer. Reasonable evidence of date of purchase must be provided.
2. This warranty extends only to defects occurring under normal use of the product when operated in accordance with the instructions.
3. Home service within the normal service area of Philips Service or one of our authorised service centres will be provided for television receivers with screen size 59cm and above. All other products are to be brought or sent to your nearest Philips Service Branch or to an authorised service centre.
4. This warranty does not cover:
  - a) Mileage or traveling time, pickup or delivery, cost of insurance.
  - b) Service costs arising from failure to correctly adjust the controls of the product or to observe the instructions, or inspections that reveal that the product is in normal working order.
  - c) Product failures caused by misuse, neglect, normal wear and tear, accidental breakage, transit damage, inexperienced repairs or modification by unauthorised persons, lightning strikes, vermin infestation or liquid spillage.
  - d) Cleaning of video or audio heads.
  - e) Inadequate receiving antennae.
  - f) Replacement of worn or used batteries, styli or other consumables.

The conditions contained in this warranty replace and override the provisions of the World-Wide Guarantee for Products sold in Australia.

### Philips Service Branches

To contact your nearest Philips Service Branch call **13 13 92** from anywhere in Australia.

#### Sydney

Technology Park  
Australia Centre  
3 Figtree Drive  
Homebush NSW 2140

#### Newcastle & Central Coast

984 Hunter Street  
Newcastle West NSW 2302

#### Perth

1 Fredrick Street  
Belmont WA 6104

#### Melbourne

Cnr Wellington &  
Springvale Roads  
Mulgrave VIC 3170

#### Brisbane

10 Graystone Street  
Tingalpa QLD 4173

#### Also Service Centres:

##### Adelaide

348 Torrens Road  
Croydon Park SA 5008

##### Hobart

2A Pierce Street  
Moonah TAS 7009

##### Wollongong

1/216 Corrmal Street  
Wollongong NSW 2500

##### Canberra

Unit F,  
66-70 Maryborough Street  
Fyshwick ACT 2609

Service is also provided through 1,200 accredited service dealers throughout Australia. To find out about your nearest centre, call **13 13 92**.

## Call us direct on the Philips Customer Helpline

Philips customer care lasts as long as you keep the product. Whenever you need any information on the care or operation of your product, remember it's always best to go straight to the source. Phone Philips Helpline direct on

**13 13 91**

**7 days a week**

— your call is always welcome.

Please record the following information for your records and keep in a safe place.

Model No:.....

Serial No:.....

***Please retain your purchase receipt  
which is required to claim service  
under warranty.***

Philips Electronics Australia Limited  
ACN 008 445 743, 3 Figtree Drive  
Homebush NSW 2140

Thank-you for purchasing this quality Philips product.

Philips New Zealand Ltd guarantees this product against defective components and faulty workmanship for a period of 12 months. Any defect in materials or workmanship occurring within 12 months from the date of purchase subject to the following conditions will be rectified free of charge by the retailer from whom this product was purchased.

### Conditions

1. The product must have been purchased in New Zealand. As proof of purchase, retain the original sales docket indicating the date of purchase.
2. The guarantee applies only to faults caused by defective components, or faulty workmanship on the part of the manufacturer.
3. The guarantee does not cover failures caused by misuse, neglect, normal wear and tear, accidental breakage, use on the incorrect voltage, use contrary to operating instructions, or unauthorised modification to the product or repair by an unauthorised technician.
4. Reasonable evidence (in the form of a sales docket) must be supplied to indicate that the product was purchased no more than 12 months prior to the date of your claim.
5. In the event of a failure, Philips shall be under no liability for any injury, or any loss or damage caused to property or products other than the product under guarantee.

This guarantee does not prejudice your rights under common law and statute, and is in addition to the normal responsibilities of the retailer and Philips.

### How to claim

Should your Philips product fail within the guarantee period, please return it to the retailer from whom it was purchased. In most cases the retailer will be able to satisfactorily repair or replace the product.

However, should the retailer not be able to conclude the matter satisfactorily, or if you have other difficulties claiming under this guarantee, please contact

### The Guarantee Controller

Philips New Zealand Ltd.

✉ P.O. Box 41.021

Auckland

☎ (09) 84 94 160

fax ☎ (09) 84 97 858

Este aparato está fabricado con materiales de alta calidad y ha sido cuidadosamente verificado. Philips, por lo tanto, da a usted una garantía de 12 meses a partir de su fecha de compra.

La garantía ampara la reposición de las piezas defectuosas debidas a fallas en su montaje o en los materiales, incluyendo la mano de obra necesaria para su reemplazo en nuestras Sucursales o talleres autorizados.

En caso de fallas en su aparato le rogamos se sirva poner en contacto con su distribuidor.

Esta garantía no cubrirá las averías que resulten como consecuencia de una instalación incorrecta del aparato, manifiesto maltrato o uso inadecuado del mismo.

Philips se obliga a reparar y devolver a usted su aparato en un plazo no mayor de 30 días hábiles contados a partir de la fecha de haber ingresado su aparato a uno de nuestros talleres.

Para que esta garantía sea válida, es necesario que el certificado que figura en la parte posterior de este instructivo haya sido debidamente llenado en el momento de la compra del aparato.

En caso de extravío del certificado con la presentación de la factura o remisión de su aparato podrá hacer efectiva la garantía correspondiente.

Si usted tiene alguna duda o pregunta que no le pueda solucionar su distribuidor, por favor ponerse en contacto con:

**Centro de Servicio Philips**  
**Blvd. de los Ferrocarriles No.339**  
**Col. Industrial Vallejo, 02300**  
**México, D.F.**  
☎ 728-42 00

**Centro de Información al Consumidor**  
☎ 368-77 88 ó 91 (800) 504-62 00

# CERTIFICADO DE GARANTIA PARA O BRASIL

(Os dados deste manual estão sujeitos a alterações.)

Este aparelho é garantido pela PHILIPS DA AMAZÔNIA INDÚSTRIA ELETRÔNICA LTDA, por um período superior ao estabelecido por lei, porém, para que a garantia tenha validade, é imprescindível que, além deste certificado, seja apresentada a nota fiscal de compra do produto.

1) A PHILIPS DA AMAZÔNIA INDÚSTRIA ELETRÔNICA LTDA, assegura ao proprietário consumidor deste aparelho a garantia de 365 dias (90 dias legal mais 275 dias adicional) **CONTADOS A PARTIR DA DATA DE ENTREGA DO PRODUTO, CONFORME EXPRESSO NA NOTA FISCAL DE COMPRA**, que passa a fazer parte deste certificado.

2) Esta garantia perderá sua validade se:

A) O defeito apresentado for ocasionado por uso indevido ou em desacordo com o seu manual de instruções.

B) O produto for alterado, violado ou consertado por pessoa não autorizada pela Philips.

C) O produto for ligado a fonte de energia (rede elétrica, pilhas, bateria, etc.) de características diferentes das recomendadas no manual de instruções e/ou no produto.

D) O número de série que identifica o produto estiver de alguma forma adulterado ou rasurado.

3) Estão excluídos desta garantia defeitos decorrentes do descumprimento do manual de instruções do produto, de casos fortuitos ou de força maior, bem como aqueles causados por agentes da natureza e acidentes.

4) Excluem-se igualmente desta garantia defeitos decorrentes do uso dos produtos em serviços não doméstico/residencial regular ou em desacordo com o uso recomendado.

5) Nos municípios onde não exista oficina autorizada de serviço Philips, as despesas de transporte do aparelho e/ou do técnico autorizado, correm por conta do Sr. consumidor requerente do serviço.

6) Este produto tem **GARANTIA INTERNACIONAL**. O serviço técnico (durante ou após a garantia) é disponível em todos os países onde este produto é oficialmente distribuído pela Philips. Nos países onde a Philips não distribui este produto, o serviço técnico da Philips local poderá prestar tal serviço, contudo poderá ocorrer algum atraso no prazo de atendimento se a devida peça de reposição e o manual técnico não forem prontamente disponíveis.

7) A garantia não será válida se o produto necessitar de modificações ou adaptações para habilitá-lo a operar em qualquer outro país que não aquele para o qual foi designado, fabricado, aprovado e/ou autorizado, ou ter sofrido qualquer dano decorrente deste tipo de modificação.

PHILIPS DA AMAZÔNIA  
INDÚSTRIA ELETRÔNICA LTDA.

Dentro do Brasil, para informações adicionais sobre o produto ou para eventual necessidade de utilização da rede de oficinas autorizadas, ligue para o CENTRO DE INFORMAÇÕES AO CONSUMIDOR, TEL 0800-123123 (discagem direta gratuita) ou escreva para a Caixa Postal 65106 – CEP 01390-970 – SÃO PAULO – SP.

Horário de atendimento: de segunda à sexta-feira, das 08:00 às 20:00 h, aos sábados das 08:00 às 13:00 h.

Para atendimento fora do Brasil, contate a Philips local ou a:

PHILIPS CONSUMER SERVICE  
BEUKENLAAN 2  
5651 CD EINDHOVEN  
THE NETHERLANDS



---

1  
2  
3  
4  
5  
6  
7  
8  
9  
10  
11  
12  
13  
14  
15  
16  
17  
18  
19  
20  
21  
22  
23  
24  
25  
26  
27  
28  
29  
30  
31  
32  
33  
34  
35  
36  
37  
38  
39  
40  
41  
42  
43  
44  
45  
46  
47  
48  
49  
50  
51  
52  
53  
54  
55  
56  
57  
58  
59  
60  
61  
62  
63  
64  
65  
66  
67  
68  
69  
70  
71  
72  
73  
74  
75  
76  
77  
78  
79  
80  
81  
82  
83  
84  
85  
86  
87  
88  
89  
90  
91  
92  
93  
94  
95  
96  
97  
98  
99  
100

---

# AW 7850 - Stereo Radio Cassette Recorder

**English.....4**

**Français.....10**

**Español.....16**

**Brasileiro .....22**

**中文.....28**

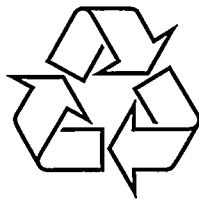

Meet Philips at the internet  
<http://www.philips.com>