

PHILIPS

AS 440 / AS 445 CD Midi System

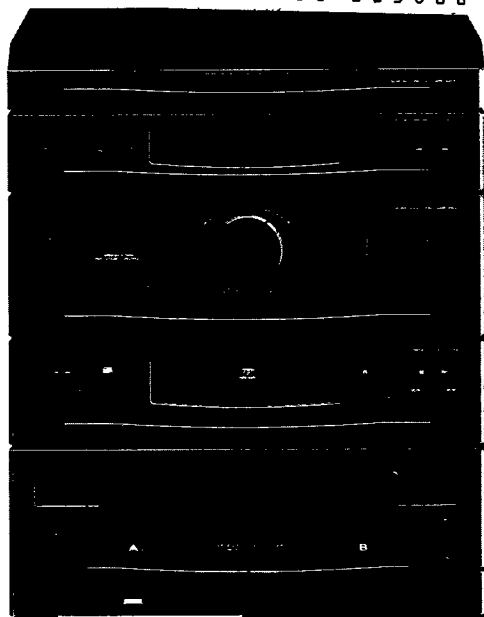

Declaración de conformidad con normas

El que suscribe, en nombre y representación de:

Audio Electronics Sdn. Bhd. – Penang

declara, bajo su propia responsabilidad, que el

equipo: **Combinación**
 fabricado por: **Audio Electronics Sdn. Bhd.**
 en: **Far East**
 marca: **Philips**
 modelos: **AS 440 / AS 445**

objeto de esta declaración, cumple con la normativa siguiente: Reglamento sobre Perturbaciones Radioeléctricas, Real Decreto 138/1989, Anexo V.

Hecho en: Penang, 06-12-1993

Firma: 

Nombre: Khoo Bee Im
 Función: Safety Co-ordinator

(MEX) México

NOM



NOM

Es necesario que lea cuidadosamente su instructivo de manejo.

(N) Norge

Typeskilt finnes på apparatens bakside.

Observer: Nettbryteren er sekundert innkoplet. Den innebygde nettdelen er derfor ikke frakoplet nettet så lenge apparatet er tilsluttet nettkontakten.

(AUS) Australia

Guarantee.....page 91

(NZ) New Zealand

Guarantee.....page 91

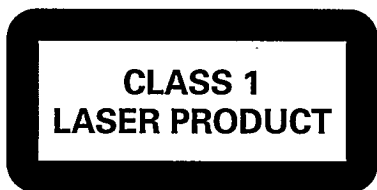

(GB) English.....3

Troubleshooting list.....12
 Illustrations.....92-95

(F) Français 13

Liste des remèdes en cas de panne.....22
 Illustrations.....92-95

(D) Deutsch23

Fehlersuch-Liste32
 Abbildungen92-95

(NL) Nederlands.....33

Het verhelpen van storingen.....42
 Afbeeldingen92-95

(E) Español.....43

Localización de desperfectos52
 Ilustraciones92-95

(I) Italiano.....53

Elenco ricerca guasti.....62
 Illustrazioni92-95

(DK) Dansk.....63

Fejlfindings-liste72
 Figurer.....92-95

(S) Svenska73

Felsökningstabell81
 Figurer.....92-95

(FIN) Suomi.....82

Tarkistusluettelo90
 Kuvat.....92-95

INSTALLATION

Installation

- After unpacking the system, remove all protective material. All redundant packaging material has been omitted. We have done our utmost to make the packaging easy separable into three mono-materials:

- cardboard (box)
- expandable polystyrene (buffer)
- polyethylene (bags, protective foam sheet)

Please observe the local regulations regarding the disposal of these packaging materials.

- Do not cover any vents and make sure that you leave sufficient room free around the unit for ventilation.
- Fully tighten both record player transit screws  (Fig. 3). Screw in clockwise direction. (*Record player not on all versions*).
- Your set consists of materials which can be recycled and reused if disassembled by a specialized company. Please inquire about local regulations on how to hand in your old set for recycling.

Connections, fig. 1 and 10

- (A) VOLTAGE SELECTOR** (not on all versions)
If your system has a voltage selector, set it to the local mains voltage.
- (B) PHONO SUPPLY** – Socket for connecting a record player that is not itself connected to the mains.
- (C) SPEAKERS** – Terminals for two loudspeakers, impedance of original speakers 6 Ohm, if other speakers are used, at least 8 Ohm.
- One of the two wires of a loudspeaker cable is marked, e.g. with a colour or rib. The marked wire should be connected to the red terminal and the unmarked one to the black terminal. Make sure that the colour combination of wire and terminal is the same for each loudspeaker.
- The position of the loudspeakers should be carefully selected to achieve the best possible stereo effect. As every room has different characteristics, the best position can only be found by experimenting. The bass frequencies will be emphasised if you place the loudspeakers on the floor or in a corner. Treble response will be weakened if you place the loudspeakers behind furniture or curtains. Try to keep the arrangement as symmetrical as possible, also with regard to the height of the speakers.

- (D) MAINS** – Socket for mains lead.
N.B.: Check that the local mains voltage corresponds to the voltage indicated on the type plate before connecting the system to the mains. If this is not the case, consult your dealer. *The type plate is located at the rear of the system.*
- (E) AUX/PHONO** – Sockets for a dynamic record player with a built-in pre-amplifier and a linear output (e.g. PHILIPS AK 540), TV set, VCR, etc.
- (F) FM AERIAL** – Socket for FM (ultrashort wave) aerial, 75 Ohm, for connection to a central aerial installation. The auxiliary wire aerial that is supplied can also be connected to this socket. Adjust the direction of this aerial so as to obtain optimum reception. For good FM stereo reception, we recommend the use of an FM outdoor aerial.

Important notes for users in the U.K.:

Mains plug

This apparatus is fitted with an approved moulded 13 Amp plug. To change a fuse in this type of plug proceed as follows:

- Remove fuse cover and fuse
- Fix new fuse which should be a BS1362 5 A, A.S.T.A. or BSI approved type.
- Refit the fuse cover

If the fitted plug is not suitable for your socket outlets, it should be cut off and an appropriate plug fitted in its place. If the mains plug contains a fuse, this should have a value of 5 A. If a plug without a fuse is used, the fuse at the distribution board should not be greater than 5 A.

Note: The severed plug must be disposed to avoid a possible shock hazard should it be inserted into a 13 A socket elsewhere.

How to connect a plug

The wires in the mains lead are coloured with the following code: blue = neutral (N), brown = live (L). As these colours may not correspond with the colour markings identifying the terminals in your plug, proceed as follows:

- Connect the blue wire to the terminal marked N or coloured black
- Connect the brown wire to the terminal marked L or coloured red.
- Do not connect either wire to the earth terminal in the plug, marked E (or \perp) or coloured green (or green and yellow)

Before replacing the plug cover, make certain that the cord grip is clamped over the sheath of the lead - not simply over the two wires.

Copyright: Recording and playback of material may require consent. See Copyright Act 1956 and The Performer's Protection Acts 1958 to 1972.

CONTROLS

Front panel, Fig. 2

Receiver (Amplifier/Tuner)

- ① **TUNER, CD, TAPE and PHONO/AUX** – function selector keys for selecting the sound source
- ② **STANDBY ON** – for switching on and off
- ③ **VOLUME** – volume control with STANDBY display (flashes when the remote control is used)
- ④ **REMOTE SENSOR** – receives the infrared signals from the remote control
- ⑤ **AUTO PROGRAM** – key for automatic programming of preset stations
- ⑥ **MONO STEREO** – for switching over to mono reception to reduce interference caused by weak stereo reception
- ⑦ **Display**
- ⑧ **PROGRAM** – key for manual programming of preset stations
- ⑨ **BAND** – key for selecting LW, MW or FM waveband
- ⑩ **PRESETS -/+** – keys for tuning to a preset station
- ⑪ **◀ TUNING ▶** – keys for tuning to a desired frequency
- ⑫ **4-BAND GRAPHIC EQUALIZER** – for adjusting the sound to your individual taste
DBB – Dynamic Bass Boost for emphasising the bass frequencies
- ⑬ **HIGH SPEED DUBBING** – for recording from one cassette deck to the other at high speed

CD player

- ⑭ **CD tray** – for insertion of a CD
- ⑮ **STOP** – key for stopping playback
PLAY – key for starting playback
- ⑯ **◀◀ TRACK SKIP ▶▶** – keys for selecting the next or the previous track and searching for a particular passage during playback
- ⑰ **OPEN/CLOSE** – key for opening and closing the CD tray
- ⑱ **INTROSCAN** – key for playing the first ten seconds of all tracks of a CD or of a program
PAUSE – key for interrupting playback
- ⑲ **PROGRAM** – key for programming the tracks
- ⑳ **CLEAR** – key for erasing the program
REVIEW – key for displaying all programmed tracks
- ㉑ **SHUFFLE** – key for playing back a CD or a program in random order
REPEAT – key for repeating playback of a CD or of a program

Cassette decks

- ㉒ **PHONES** – socket for stereo headphones (minimum impedance 32 Ohm). The loudspeakers are switched off when headphones are connected.
- ㉓ **STOP/EJECT** – for stopping the cassette tape and opening the cassette compartment
RECORD – for starting recording
PLAY – for starting playback
REWIND – fast winding in reverse direction
WIND – fast winding in forward direction
PAUSE – for interrupting playback or recording
- ㉔ **MIC MIX** – (*not on all versions*) for adjusting the level of the microphone signal
- ㉕ **MICRO** – (*not on all versions*) microphone socket

Record player, Fig. 3 (*not on all versions*)

- ⚠ Adaptor for 45 rpm records
- ⚠ Transport safety screws
- ⚠ Pickup arm finger lift for raising and lowering the pickup arm
- ⚠ Rpm selector for selecting the appropriate speed (33 or 45)
- ⚠ Pickup arm clamp

CONTROLS

AMPLIFIER

Remote control, Fig.4

- **STANDBY** \odot – for switching to the standby mode
- **PHONO (AUX), CD, VCR, TV, TUNER** – function selector keys for selecting the signal source (TV or VCR can only be selected if the unit uses the RC-5 remote control system).
- **DISC** ∇ or \blacktriangle – CD selection (with CD changer)
- **SHUFFLE** – for playing a CD in random order (CD)
- **PREV.** \blacktriangleleft or **NEXT** \blacktriangleright – for playing back the previous or the next track (CD) and selecting the preset station (TUNER)
- **REPEAT** – for repeating a CD or a program (CD)
- **SEARCH** $\blacktriangleleft\blacktriangleright$ – for tuning to a preset station (TUNER) and searching for a particular passage (CD)
- **SCAN** – for playing the beginning of each track (CD)
- **STOP** – for stopping playback (CD)
- **PLAY** – for starting playback (CD)
- **PAUSE** – for interrupting playback (CD)
- **VOLUME** $-/+$ – for adjusting the volume

Switching on and off / standby

- Switch on the unit with **STANDBY ON** $\textcircled{2}$.
- Press the required function selector key $\textcircled{1}$: **TUNER, CD, TAPE** or **PHONO/AUX**
- Adjust the volume with the **VOLUME** control $\textcircled{3}$.
- If necessary, adjust the sound with the **4-BAND EQUALIZER** controls $\textcircled{12}$ and/or the **DBB** – Dynamic Bass Boost – control $\textcircled{12}$.
- By pressing the **STANDBY ON** switch $\textcircled{2}$ on the amplifier, the unit is switched off. To switch off the power supply, remove the mains plug.
- If the **STANDBY** \odot key is pressed on the remote control, the unit switches into the standby mode.
- If you press the **STANDBY ON** switch $\textcircled{2}$ when the unit is already in the standby mode, the sound source last selected is activated.
- If the unit is in the standby mode, you can also switch it on with the **TUNER, CD, TAPE** and **PHONO/AUX** keys $\textcircled{1}$ or with any other play function key.

Note: Switching off the standby mode overnight will save energy.

How to use the remote control

- Always first select the desired signal source and then press the appropriate key (e.g. **CD, PLAY** and **VOLUME** $-/+$ for adjusting the volume). The remote control will remain tuned to the selected unit until another function selector key is chosen.

Automatic source selection

Automatic source selection occurs, e.g.

- **TUNER**, when pressing the **TUNING** \blacktriangleleft or \blacktriangleright $\textcircled{11}$, **PRESETS** $-/+$ $\textcircled{10}$ or **BAND** $\textcircled{9}$ key
- or **CD**, when pressing the **PLAY** $\textcircled{16}$, **OPEN/-CLOSE** $\textcircled{17}$ (if a CD is inserted in the CD tray), **INTROSCAN** $\textcircled{18}$ or **SHUFFLE** $\textcircled{21}$ key.

Batteries

- Open the battery compartment and insert the supplied batteries as indicated.
- Remove the batteries when they have run down or if they will not be used again for a long period. For replacement use only batteries of the type R03, UM-4 or AAA.

Microphone mixing (not on all versions)

By connecting a microphone with 6.3 mm plug to the **MICRO** socket $\textcircled{25}$ you can mix your voice with any other source. It is also possible to record the mixed signal on your cassette deck. However, recording is not possible in position **TAPE**.

- Before connecting the microphone, set **VOLUME** $\textcircled{3}$ to minimum.
- Adjust the mixing ratio with the **MIC MIX** $\textcircled{24}$ control.

Do not dispose of exhausted batteries with your household waste. Please inquire about how to dispose of batteries according to local regulations.

Important

This set is automatically protected against overheating which could be caused by e.g. high volume over too long a period of time. If necessary, the set will automatically cool down. During cooling, the output power (volume) will be reduced and "H.C.C." will flash on the display.

TUNER

Tuning Grid

Changing to 10 or 9 kHz:

In North and South America the frequency step between adjacent channels in the AM band has to be 10 kHz. In all other parts of the world this step is 9 kHz. In some versions of this unit the frequency step can be changed.

To change to 10 kHz, proceed as follows:

- Remove the mains plug to switch off the power supply.
- Press the keys **BAND** (9) and **TUNING** (11) both pressed down and connect the unit to the mains again. The display will show for approx. 2 seconds: AM 10 kHz.
- To change back to 9 kHz, repeat this procedure with the keys **BAND** (9) and **TUNING** (11). The display will show for approx. 2 seconds: AM 9 kHz.

Deleting the LW waveband:

In some countries (Australia, New Zealand, etc.) the LW waveband does not exist. In some versions of this unit it is therefore possible to delete the LW waveband. To do so, proceed as follows:

- Remove the mains plug to switch off the power supply.
- Keep the keys **BAND** (9) and **TUNING** (11) both pressed down and connect the unit to the mains again. The display will show for approx. 2 seconds: LW OFF.
- To reactivate the LW waveband, repeat this procedure with the keys **BAND** (9) and **TUNING** (11). The display will show for approx. 2 seconds: LW ON.

Tuning

- Press the **TUNER** key (1).
- Select the waveband with the **BAND** key (9).
- Tune to the desired station:
- Press the **TUNING** (11) or **TUNING** (11) key (the **SEARCH** (11) or **SEARCH** (11) key on the remote control). The frequency display will change until a station with sufficient strength is found. Repeat this procedure until you find the desired station.
- In order to tune to a weak station, briefly (for less than half a second) press the **TUNING** (11) or **TUNING** (11) key (11) a few times until the display shows the right frequency and/or optimum reception has been obtained.
- To reduce interference caused by poor FM stereo reception, switch over to mono reception with the **MONO STEREO** key (6). The **STEREO** indication will be deleted on the display (7).

Tuning to preset stations

Up to 30 preferred stations can be stored in the memory of the tuner. When you tune to a preset station, a preset number (1 to 30) appears on the display next to the frequency.

- Press the **TUNER** key (1).
- Using the **PRESETS** (10) key (10) (the **PREV.** (10) or **NEXT** (10) key on the remote control), select the preset number (1 to 30) of the station.

Programming

- Press the **TUNER** key (1).
- Press the **PROGRAM** key (8).
- Tune to the station to be programmed with the **TUNING** (11) or **TUNING** (11) keys (11), as described above.
- Choose a preset number for the preset station with the **PRESETS** (10) key (10).
- Press the **PROGRAM** key (8). The station will now be stored in the memory.
- During programming, the symbol **PROGRAM** will flash on the display (7).







Automatic programming

- Press the **TUNER** key (1).
- Press the **AUTO PROGRAM** key (5) for more than half a second. The tuner will automatically begin to tune to stations. Once a station has been found, the frequency and the preset number under which the station is stored in the memory will appear on the display. All previously programmed memory positions will be overwritten and therefore erased.
- During programming, the symbol **AUTO PROGRAM** flashes on the display (7).
- Press **AUTO PROGRAM** key (5) again. If you wish to interrupt automatic programming of preset stations.

RECORD PLAYER

CD PLAYER

Record player (not on all versions)

- Press the **PHONO/AUX** key ①.
- Place a record on the turntable.
For records with a large centre hole, use the adaptor disc .
- Remove the stylus guard by gently pulling it forward.
- Set the appropriate speed – 33 or 45 – on the rpm selector .
- Release the pickup arm from its clamp .
- Set the lever  to **⏏**.
- Move the pickup arm inwards. This starts the record player. Then position the arm above the desired track or passage on the record.
- Move the lever  carefully to the **⏏** position. Playback of the record begins.
- At the end of the record the pickup arm returns to its support and the record player is automatically switched off.
- Record playback can be stopped at any given time by setting the lever  to the **⏏** position and then moving the pickup arm outwards. When the pickup arm reaches the support, the turntable will stop. The lever  can now be set to the **⏏** position, the arm secured and the stylus guard replaced.

N.B.: At first it is possible that the pickup arm will not return to its support. If this happens, move the pickup arm by hand – gently! – to the centre of the record. Once the mechanism has been actuated in this way, it will subsequently operate automatically.

Playing a CD

- Press the **CD** ① key.
- The message "CD DISC" will appear on the display.
- Open the CD tray by pressing the **OPEN/CLOSE** key ⑰.
- Remove the CD from its box and place it in the tray with **printed side up** (fig. 5). The CD player can play normal CDs with a diameter of 12 cm and also small CDs with a diameter of 8 cm (CD singles). An adaptor ring for 8 cm CDs is not required.
- Close the CD tray by pressing the **OPEN/CLOSE** key ⑰. The tray will also close if you press against it lightly or start playback with the **PLAY** ⑱, **SHUFFLE** ⑳ or **INTROSCAN** ㉑ key.
- The number of tracks and the total playing time of the CD will appear on the display.
- Start playback by pressing the **PLAY** key ⑱. Playback can also be started with **SHUFFLE** ⑳ or **INTROSCAN** ㉑.
- The number and the playing time of the track that is being played will now appear on the display. To interrupt playback briefly, press the **PAUSE** key ㉒. The symbol PAUSE will then appear on the display. To resume playback, press the **PLAY** key ⑱.
- To stop playback, press the **STOP** key ㉓. The CD player will also return to the STOP position if:
 - the **OPEN/CLOSE** key ⑰ is pressed;
 - the end of the CD has been reached.

SHUFFLE – playback in random order

- Press the **SHUFFLE** key ⑳. The symbol SHUFFLE and the CD track selected at random will appear on the display.
- The CD will now be played back in random order, until all the tracks have been played or you stop playback by pressing the **STOP** key ㉓.

INTROSCAN – playing the first 10 seconds of each track

- Press the **INTROSCAN** key ㉑ before or during playback. "SCAN" will appear on the display. The INTROSCAN function can be activated from the STOP and PLAY position. The beginning of each track in turn is played for 10 seconds. The number of the track that is being played will appear on the display.
- As soon as the **PLAY** ⑱ or **SHUFFLE** ⑳ key is pressed, the INTROSCAN function is cancelled and the CD is played back in the normal way.

Track selection during playback in the PLAY or INTROSCAN mode

- Press the **TRACK SKIP** ◀◀ or ▶▶ key ⑯ briefly (less than half a second) until the desired track appears on the display. Playback starts automatically.

Track selection during playback in the SHUFFLE mode

- Press the **TRACK SKIP** ◀◀ or ▶▶ key ⑯ briefly (less than half a second). The next track selected at random will appear on the display and playback of this track begins.

Searching for a particular passage during playback in the PLAY mode

- Hold down the **TRACK SKIP** ◀◀ or ▶▶ key ⑯ (for more than half a second) until the desired passage is located. During the search the sound is played back faster than normal. Playback resumes at the normal speed once the key is released.

Starting playback with a particular track from STOP

- Press the **TRACK SKIP** ◀◀ or ▶▶ key ⑯ briefly (for less than half a second) until the desired track appears on the display.
- Press the **PLAY** key ⑮ to start playback with the selected track.

REPEAT – repeating CD playback

- Press the **REPEAT** key ㉑ before or during playback. The REPEAT symbol will appear on the display. The REPEAT function can be activated from the STOP, PLAY and SHUFFLE position. The tracks will be repeated according to the playback mode which you have selected.
- To end the repeat function, press the **REPEAT** key ㉑ once more.

Programming tracks

Up to 25 tracks per CD can be stored in the memory in any order. If you try to store more than 25 tracks in the memory, the message "FULL" will appear on the display.

Programming in STOP mode

- Select the desired track with the **TRACK SKIP** ◀◀ or ▶▶ key key ⑯.
- Store the track number in the memory by pressing the **PROGRAM** key ⑲.
- As soon as the **PROGRAM** key ⑲ is pressed, the symbol PROGRAM and the number and total playing time of the tracks which have already been stored will appear on the display.
- Select and store all desired tracks in this way.

Programming during playback

- As soon as a track that is to be stored is played back, press the **PROGRAM** key ⑲.

Checking the program

- If you press the **REVIEW** key ㉒
 - in STOP-mode, all the stored track numbers in the preselected order will appear on the display.
 - during playback, all track numbers from the program, which still have to be played back, will appear on the display.

Playing back a program

- To play back the program, press the **PLAY** key ⑮.

Erasing a program

- Press the **CLEAR** key ㉓ in the STOP mode. This will erase the entire program.
- Pressing the **OPEN/CLOSE** key ⑰ or **STANDBY** ⏻ on the remote control will also erase the program.

Erasing a track from the program

- Press the **REVIEW** key ㉒ in the STOP mode. All the stored tracks will appear on the display in the order which you have selected.
- Press the **CLEAR** key ㉓ as soon as the track which is to be erased is shown on the display. "CL-" will appear on the display, followed by the next stored track.

CD PLAYER

CASSETTE DECKS

Selecting another source during playback

- You can select another source during playback of a CD.
 - When you press the **CD** key ① again, the CD player will return to the original mode: PLAY, SHUFFLE, INTROSCAN, REPEAT or PROGRAM.
- Playback of the CD will resume at the position, where it has been interrupted.

N.B.: Playback cannot be resumed when the unit has been switched to STANDBY in the meanwhile.

CD display

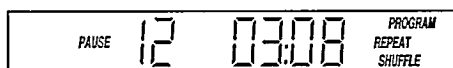

PAUSE – lights up when you interrupt playback
PROGRAM – lights up when a program is available.

REPEAT – lights up when you repeat a CD.

SHUFFLE – lights up when you play the tracks in random order.

OPEN – lights up when you open the CD tray.

--- – lights up when you close the CD tray.

no DISC – lights up when there is no CD in the CD tray and the tray is closed.

Err – lights up when you make an error in operating the CD player and if the CD player cannot read the CD (see "TROUBLESHOOTING LIST").

SCAN – lights up when you play the first seconds of the tracks (INTROSCAN).

CLR – lights up when you erase a track from the program.

FULL – lights up when you try to store more than 25 tracks in the memory.

no PROG – lights up when you press the CLEAR or REVIEW key although there is no program available.

Recording (deck A only)

Copyright: Recording is permitted only in so far as copyrights (or other rights of third parties are not thereby infringed. (Not applicable to Germany)

Preparing for recording

- To ensure optimum sound quality, we recommend the use of FERRO cassettes (IEC type I).
- Using the **TUNER, CD** or **PHONO/AUX** key ①, select the sound source to be recorded from.
- Open cassette compartment A by pressing the **STOP/EJECT** key ② and insert a cassette in the compartment, with the open side downwards and the full spool on the left (fig. 7).
- Do not use protected cassettes (i.e. cassettes with the tabs removed, fig 8), as the **RECORD** key ③ will not function properly.
- Press the **PAUSE** key ④ of deck A.
- Press the **RECORD** key ③ of deck A.
- Start recording by pressing the **PAUSE** key ④ once more.
- To interrupt recording briefly, press the **PAUSE** key ④ of deck A. To resume recording, press the **PAUSE** key once more.
- End recording by pressing the **STOP/EJECT** key ② of deck A.

CD SYNCHRO – recording from the CD player

- Press the **CD** key ①.
- Switch the CD player to STOP.
- Open cassette compartment A by pressing the **STOP/EJECT** key ② and insert a cassette in the compartment, with the open side downwards and the full spool on the left (fig. 7).
- Press the **RECORD** ③ key of deck A.
- Playback of the CD player starts automatically.
- Recording starts from the beginning of the CD or the stored program.
- When the end of the tapeside has been reached (or when the **STOP/EJECT** key ② of deck A is pressed), recording will stop.
- Playback of the CD player will continue.

N.B.: If no program is available, CD SYNCHRO will always start with the first track of the CD. When you resume the recording on the second side of the tape – without a stored program – you therefore cannot use CD SYNCHRO.

- Switch the CD player to PAUSE.
- Make the recording as described in the chapter "Preparing for recording".

CASSETTE DECKS

Playback

- Any type of cassette can be used.
- Press the **TAPE** key ①.
- Playback is possible with either of the two cassette decks A and B. If **both PLAY** keys are pressed at the same time, deck B takes precedence.
- Open cassette compartment A by pressing the **STOP/EJECT** key ② and insert a cassette in the compartment with its open side downwards (fig. 7).
- Press the **PLAY** key ③.
- To interrupt playback briefly, press the **PAUSE** key ④. To resume playback, press the **PAUSE** key once more.
- End playback by pressing the **STOP/EJECT** key ②.

Continuous playback

- Press the **TAPE** key ①.
- Open both cassette compartments by pressing the **STOP/EJECT** keys ② and insert a recorded cassette in both compartments (fig. 7).
- Press the **PLAY** key ③ of deck B.
- Press the **PAUSE** key ④ of deck A.
- Press the **PLAY** key ③ of deck A.
- When the end of the cassette in deck B has been reached (or when the **STOP/EJECT** key ② of deck B is pressed), playback of the cassette in deck A will begin.

Dubbing

– recording from deck B to deck A

- Press the **TAPE** key ①.
- Select the dubbing speed with the **HIGH SPEED DUBBING** key ⑩. Do **not** press this key **during** dubbing.
- Open both cassette compartments by pressing the **STOP/EJECT** ② keys, insert the recorded cassette in deck B and the cassette which is to be dubbed in deck A (fig. 7).
- Press the **PAUSE** ④ key and then the **RECORD** ⑪ key of deck A.
- Dubbing will begin as soon as the **PLAY** ③ key of deck B is pressed.
- To omit undesired passages, press the **PAUSE** ④ key of deck A; deck B will continue to play. To resume dubbing, press the **PAUSE** ④ key once more.
- You can record a blank passage by pressing the **PAUSE** ④ key of deck B. Resume recording by pressing the **PAUSE** ④ key once more.
- You can stop dubbing by pressing both **STOP/EJECT** ② keys.

Fast winding

- By pressing the **WIND** ⑫ and **REWIND** ⑬ keys, fast winding of the tape is possible in both directions.
- To stop fast winding, press the **STOP/EJECT** ② key.

Automatic switching-off

- If the end of the tape is reached during recording, playback or fast winding, the tape will stop and the respective key will automatically be switched off.

Cassettes

- The tape in the cassette is secured at both ends with leader tape. You should bear in mind, therefore, that at the beginning and at the end of the cassette nothing will be recorded for 6 to 7 seconds!
- When a new recording is made, the old one will automatically be erased. However, the accidental erasure of a recording can be prevented by breaking the small plastic projection in the top left-hand corner on the back of the cassette (fig. 8). This protection against erasure or recording can be reversed by sticking a small piece of adhesive tape over the aperture that has been made.
- After use, store your cassettes in the box provided. Do not place them in the sunlight or close to magnets and transformers of, for example, TV sets and loudspeakers.

MAINTENANCE

CD and CD player maintenance

- Never write on the printed side of a CD.
- Do not attach stickers to the CD.
- Keep the shiny surface of the CD clean. For cleaning, use a lint-free cloth and always wipe the disc in a straight line from the centre to the edge (fig. 6).
- Never use cleaning agents intended for conventional records.
- Never use detergents or abrasive cleaning agents.
- For cleaning the CD player, use a chamois leather slightly moistened with water.
- Do not expose the unit to direct sunlight for any length of time and do not expose it to excessive heat (e.g. close to heating equipment).
- Do not expose the unit to dampness or rain.

Cassette deck maintenance

After approximately 15 hours of use the heads (A) and (B), the capstan (C) and the pressure roller (D) (fig. 9) must be cleaned. If this is not done, both recording and playback quality may be impaired.

- You can clean these parts by playing an SBC 114 cleaning cassette or by using a swab dipped in alcohol. When cleaning, make sure that the unit is not connected to the mains.
- The drive mechanism must **not** be lubricated!

Record player maintenance

Because self-lubricating bearings are used, the record player requires no maintenance.

- The stylus unit can be removed in one piece and replaced (figs. 11 and 12). Carefully press the front edge of the stylus unit downwards until it comes loose. Mount a new stylus unit by first sliding the rear part of the stylus unit into place. Then push the foremost part upward until you can feel and hear the stylus click into place.
- The dust cover is fitted with frictional hinges. It can be set to almost any position. If this is not the case, carefully tighten the screws (E), fig. 1.
- The hinges must **not** be lubricated!

This unit complies with the radio interference requirements as laid down in EC (European Community) regulations.

TROUBLESHOOTING LIST

English

If you are unable to remedy a problem by following these hints, consult your dealer or service facility. Under no circumstances should you try to repair the system yourself, as this would invalidate the guarantee.

PROBLEM	POSSIBLE CAUSE	SOLUTION
GENERAL		
No power	<ul style="list-style-type: none"> • Mains lead is not connected securely 	<ul style="list-style-type: none"> • Connect the mains lead
No or bad sound	<ul style="list-style-type: none"> • Volume is not turned up • Loudspeakers are not or wrong connected • Use of other loudspeakers • Headphones are connected 	<ul style="list-style-type: none"> • Turn up the volume • Connect the loudspeaker cables correctly • Use the original loudspeakers • Disconnect headphones
Reversed left and right sound	<ul style="list-style-type: none"> • Wrong connection of loudspeakers 	<ul style="list-style-type: none"> • Connect the loudspeaker cables correctly
System does not react to operation of any key	<ul style="list-style-type: none"> • Electrostatic discharge 	<ul style="list-style-type: none"> • Disconnect the system from power supply and reconnect it after a few seconds
TUNER		
Severe hum or noise	<ul style="list-style-type: none"> • FM aerial is not connected • Loose connections • Unit is too close to TV/VCR 	<ul style="list-style-type: none"> • Connect FM aerial • Make connections securely • Move TV/VCR away from unit
CD PLAYER		
"no DISC" or "Err" indication	<ul style="list-style-type: none"> • Surface of CD is badly scratched • CD is very dirty • No CD is inserted or CD is incorrectly inserted • Lens of laser scanner has clouded over 	<ul style="list-style-type: none"> • Use another CD • Clean the CD (see "Maintenance") • Insert a CD with the label facing upwards • Wait until unit has acclimatised
CASSETTE DECKS		
No sound	<ul style="list-style-type: none"> • TAPE source is not selected 	<ul style="list-style-type: none"> • Press the TAPE key
Bad sound	<ul style="list-style-type: none"> • Recording heads, the capstan and pressure roller are dusty and soiled 	<ul style="list-style-type: none"> • Clean these parts (see "Maintenance")
Recording is not possible or interrupts	<ul style="list-style-type: none"> • Cassette is protected against recording • No recording source is selected • The end of tapeside is reached 	<ul style="list-style-type: none"> • Stick an adhesive tape over the aperture • Select the source to be recorded from • Turn the tape
RECORD PLAYER (not on all versions)		
No sound	<ul style="list-style-type: none"> • PHONO source is not selected 	<ul style="list-style-type: none"> • Press the PHONO/AUX key
Bad sound	<ul style="list-style-type: none"> • Needle is dirty 	<ul style="list-style-type: none"> • Clean or change the needle
Pickup arm jumps out of the groove	<ul style="list-style-type: none"> • The record player is not positioned on a level surface 	<ul style="list-style-type: none"> • Position the record player on a level surface
REMOTE CONTROL		
No or no proper operation	<ul style="list-style-type: none"> • Distance between unit and remote control is too large • Batteries are incorrectly inserted • Batteries are empty 	<ul style="list-style-type: none"> • Reduce distance • Insert batteries correctly • Insert new batteries
"rc Err" indication (not on all versions)	<ul style="list-style-type: none"> • TV or VCR source is selected 	<ul style="list-style-type: none"> • Select PHONO, CD or TUNER source



Australia

Guarantee and Service

The benefits given to the purchaser by this warranty are in addition to all other rights and remedies, which, under the Trade Practices Act or other Commonwealth or State law, the purchaser or owner has in respect of the product.

The Philips product carries the following warranties:

- C-series HiFi-systems 12 months.
- Compact Disc Players: 12 months.
- Home Audio Systems: 6 months.
- Clock radios, portable radios, cassette recorders, cassette players and radio recorders: 90 days.

Any defect in materials or workmanship occurring within the specified period from the date of delivery, will be rectified free of charge by the retailer from whom this product was purchased.

Note: Please retain your purchase docket to assist prompt service.

Conditions of this warranty

1. All claims for warranty service must be made to the retailer from whom this product was purchased. All transport charges incurred in connection with warranty service or replacement will be paid by the purchaser.
2. These warranties do not cover batteries and extend only to defects in materials or workmanship occurring under normal use of the product where operated in accordance with our instructions.

**Philips Consumer Products Division,
Technology Park
Figtree Drive, Australia Centre
Homebush 2140,
New South Wales**



New Zealand

Guarantee and Service

Thank-you for purchasing this quality Philips product. Philips New Zealand Ltd guarantees this product against defective components and faulty workmanship for a period of 12 months. Any defect in materials or workmanship occurring within 12 months from the date of purchase subject to the following conditions will be rectified free of charge by the retailer from whom this product was purchased.

Conditions

1. The product must have been purchased in New Zealand. As proof of purchase, retain the original sales docket indicating the date of purchase.
2. The guarantee applies only to faults caused by defective components, or faulty workmanship on the part of the manufacturer.
3. The guarantee does not cover failures caused by misuse, neglect, normal wear and tear, accidental breakage, use on the incorrect voltage, use contrary to operating instructions, or unauthorised modification to the product or repair by an unauthorised technician.
4. Reasonable evidence (in the form of a sales docket) must be supplied to indicate that the product was purchased no more than 12 months prior to the date of your claim.
5. In the event of a failure, Philips shall be under no liability for any injury, or any loss or damage caused to property or products other than the product under guarantee.

This guarantee does not prejudice your rights under common law and statute, and is in addition to the normal responsibilities of the retailer and Philips.

How to claim

Should your Philips product fail within the guarantee period, please return it to the retailer from whom it was purchased. In most cases the retailer will be able to satisfactorily repair or replace the product.

However, should the retailer not be able to conclude the matter satisfactorily, or if you have other difficulties claiming under this guarantee, please contact

**The Guarantee Controller
Philips New Zealand Ltd.
P.O. Box 41.021, Auckland
(09) 84 94 160
fax (09) 84 97 858**

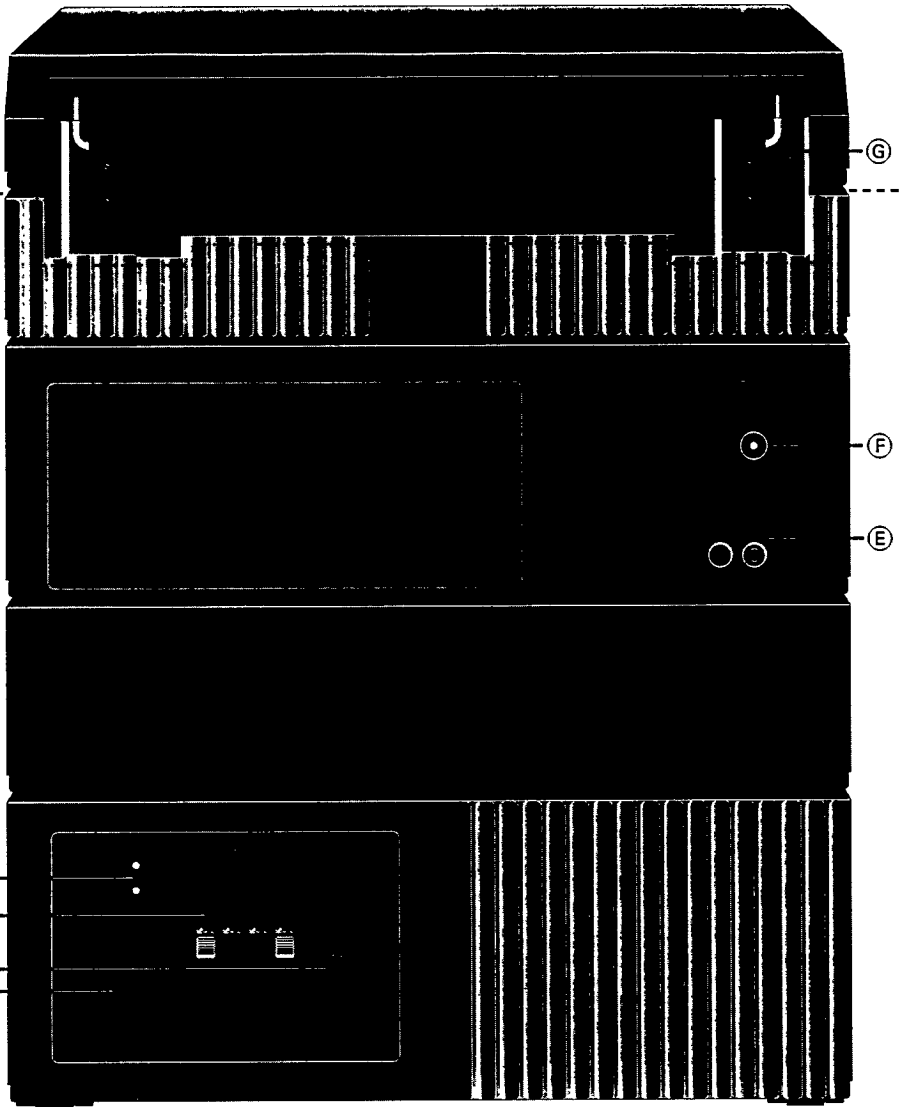

1

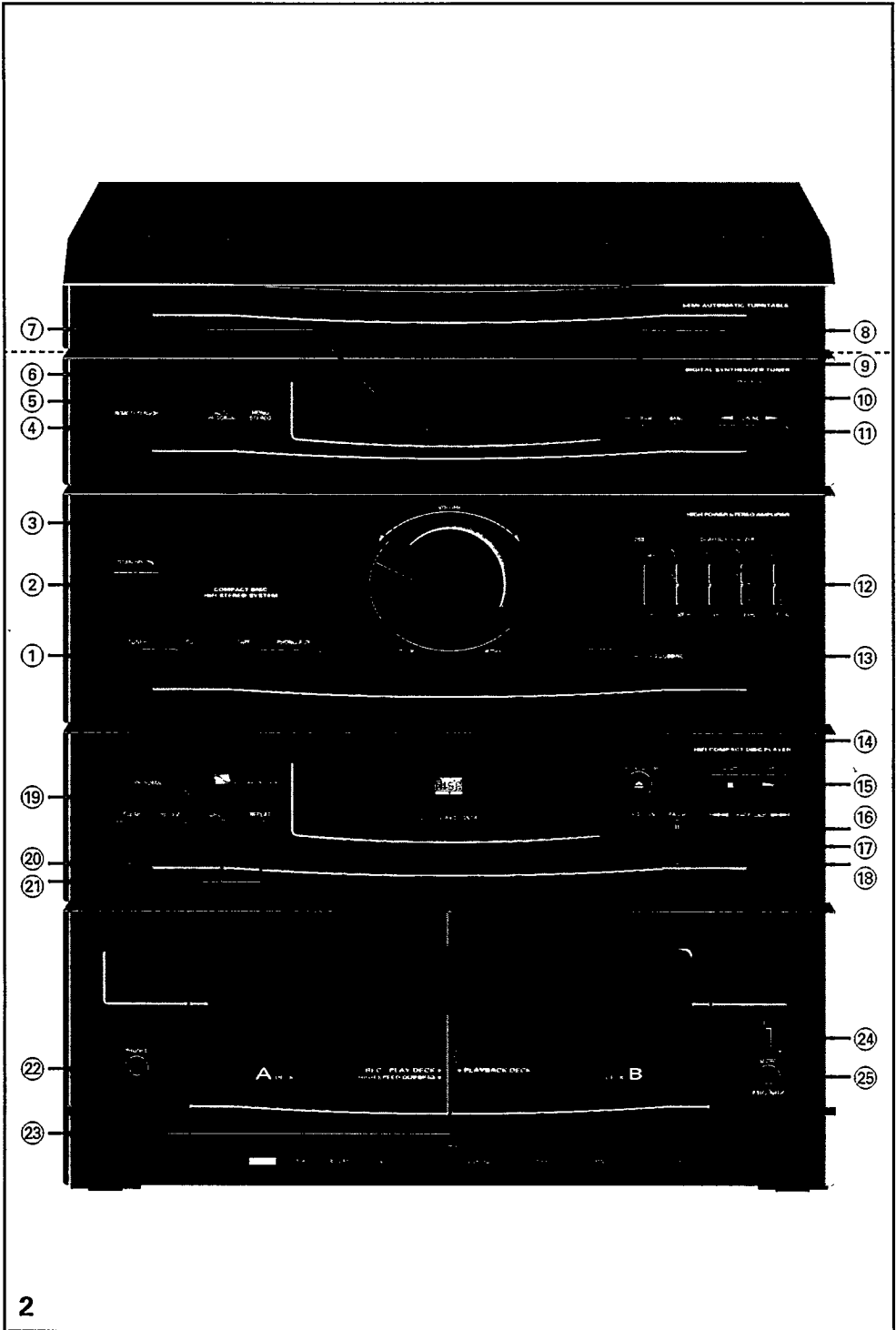

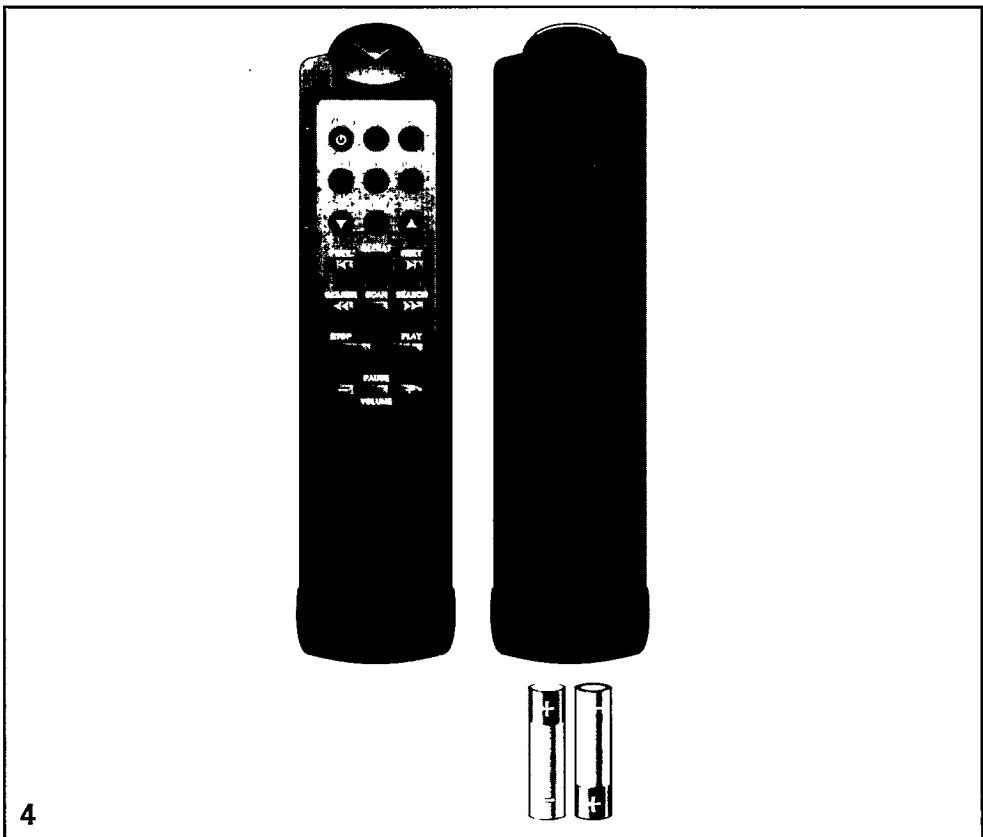
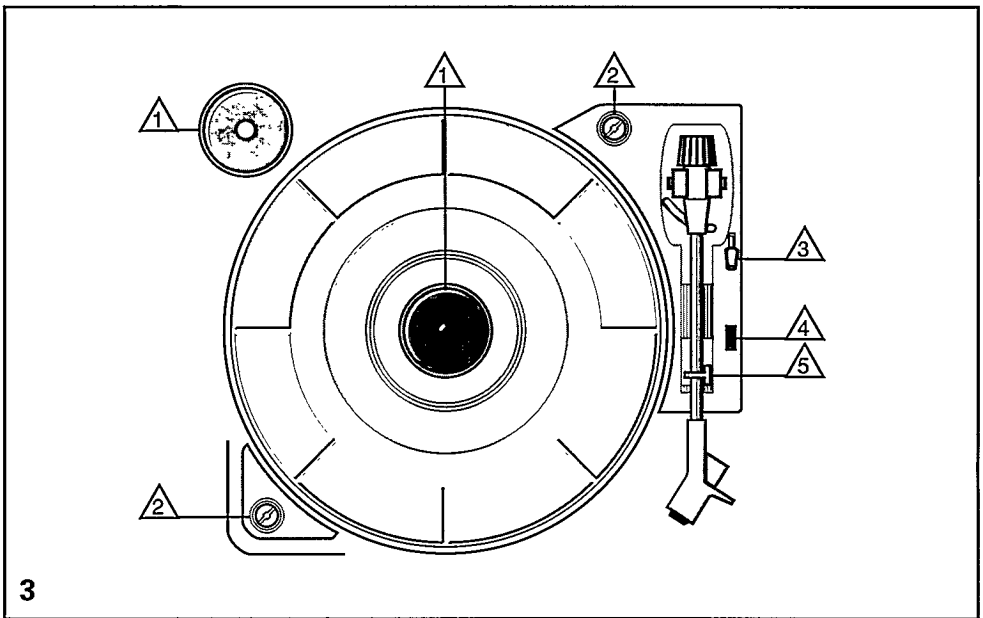

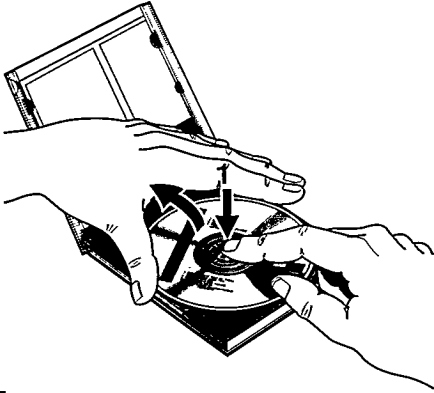

5

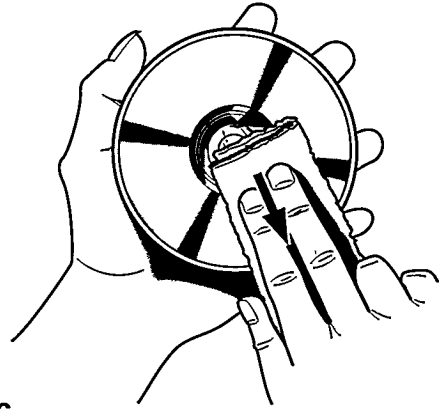

6

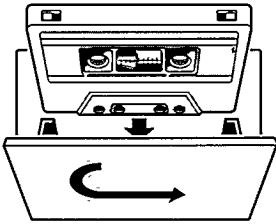

7

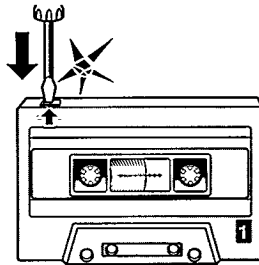

8

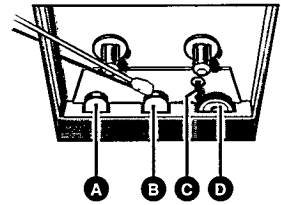

9

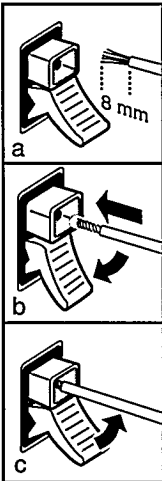

10

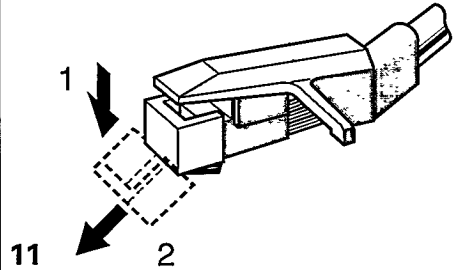
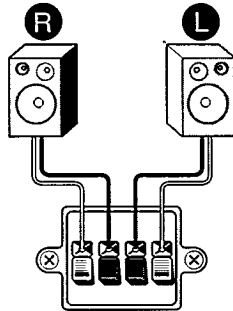

11

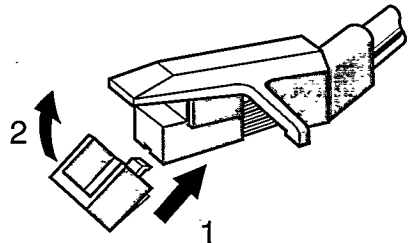

12

AS 440 / AS 445

