

Always there to help you

Register your product and get support at
www.philips.com/support

AJT5300



User manual

PHILIPS

Contents

1 Important	2
Know these safety symbols	2

2 Your clock radio	3
Introduction	3
What's in the box	3
Overview of the clock radio	4

3 Get started	5
Install battery	5
Connect power	5
Turn on	5

4 Set time and alarm	6
Set time	6
Set alarm timer	6

5 Listen to FM radio	7
Prepare FM antenna	7
Tune to FM radio stations	7
Store FM radio stations automatically	7
Store FM radio stations manually	7
Select a preset radio station	7

6 Use Bluetooth devices	8
Connect a device	8
Play audio from Bluetooth-enabled device	8
Control your phone call	9

7 Other features	10
Charge your phone	10
Listen to an external device	10
Set sleep timer	10
Adjust volume	11
Adjust display brightness	11

8 Specifications	12
-------------------------	-----------

9 Troubleshooting	13
General	13
About Bluetooth device	13

10 Notice	14
------------------	-----------

1 Important

Know these safety symbols



This 'bolt of lightning' indicates uninsulated material within your unit may cause an electrical shock. For the safety of everyone in your household, please do not remove product covering.

The 'exclamation point' calls attention to features for which you should read the enclosed literature closely to prevent operating and maintenance problems.

WARNING: To reduce the risk of fire or electric shock, this apparatus should not be exposed to rain or moisture and objects filled with liquids, such as vases, should not be placed on this apparatus.

CAUTION: To prevent electric shock, match wide blade of plug to wide slot, fully insert.

Warning

- Never remove the casing of this product.
- Never lubricate any part of this product.
- Never place this product on other electrical equipment.
- Keep this product away from direct sunlight, naked flames or heat.
- Make sure that you always have easy access to the power cord, plug or adaptor to disconnect the product from the power:

- Make sure that there is enough free space around the product for ventilation.
- Only use attachments or accessories specified by the manufacturer:

- Battery usage **CAUTION** – To prevent battery leakage which may result in bodily injury, property damage, or damage to the product:
 - Install the batteries correctly, + and - as marked on the product.
 - Do not mix batteries (old and new or carbon and alkaline, etc.).
 - Remove the batteries when the product is not used for a long time.
 - The batteries shall not be exposed to excessive heat such as sunshine, fire or the like.
- The product shall not be exposed to dripping or splashing.
- Do not place any sources of danger on the product (e.g. liquid filled objects, lighted candles).
- Where the plug of the Direct Plug-in Adapter is used as the disconnect device, the disconnect device shall remain readily operable.

Note

- The type plate is located on the bottom of the product.

2 Your clock radio

Congratulations on your purchase, and welcome to Philips! To fully benefit from the support that Philips offers, register your product at www.philips.com/welcome.

Introduction

With this clock radio, you can

- play audio from Bluetooth-enabled devices, or other external devices;
- listen to FM radio;
- charge your mobile devices; and
- set two alarms to ring at different time.

What's in the box

Check and identify the contents of your package:

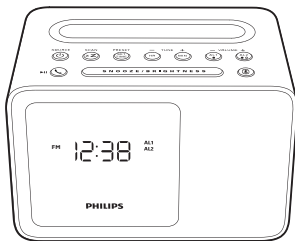

- Clock radio
- Printed materials

Overview of the clock radio

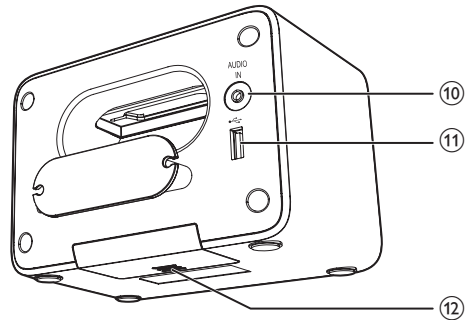
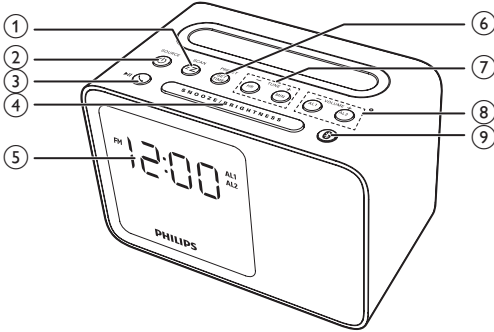

① SCAN/ zZ

- Press to set sleep timer.
- Press and hold for two seconds to store radio stations automatically.

② SOURCE

- Turn on the clock radio.
- Switch to standby mode.
- Select a source: Bluetooth, FM, or Aux.

③

- In Bluetooth mode, press to start, pause, or resume play.
- Press to answer an incoming call.
- Press and hold for two seconds to reject an incoming call.
- During a call, press to end the current call.

④ SNOOZE/BRIGHTNESS

- Snooze the alarm.
- Adjust display brightness.

⑤ Display panel

- Show current status.

⑥ PRESET/SET TIME

- Store radio stations manually.
- Select a preset radio station.
- Set time.

⑦ HR/MIN/- TUNE +

- Tune to FM radio stations.
- Set hour and minute.

⑧ AL1/AL2/- VOLUME +

- Set alarm.
- Adjust volume.

⑨

- Press and hold for two seconds to enter pairing mode.

⑩ AUDIO IN

- Connect an external audio device.

⑪ DC 5V = 1A

- Charge your phone.

⑫ Battery compartment

- Install battery.

3 Get started

Always follow the instructions in this chapter in sequence.

Install battery

The batteries can only back up clock and alarm settings when AC power is disconnected.

! Caution

- The batteries contain chemical substances, so they should be disposed of properly.

- 1 Open the battery compartment.
- 2 Insert 2 AA batteries with correct polarity (+/-) as illustrated.

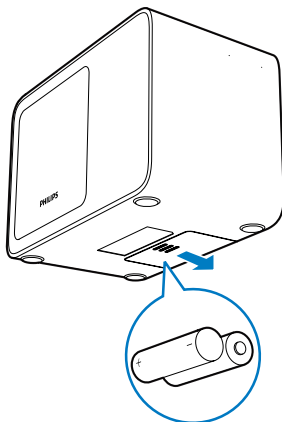

- 3 Close the battery compartment.

* Tip

- When there is no battery inserted or the battery level is low, the low battery indicator is displayed.
- The display backlight is off when AC power is disconnected.

Connect power

! Caution

- Risk of product damage! Make sure that the power voltage corresponds to the voltage printed on the back or underside of the clock radio.
- Risk of electric shock! When you unplug the AC adapter, always pull the plug from the socket. Never pull the cord.

Connect the AC power adaptor to the wall socket.

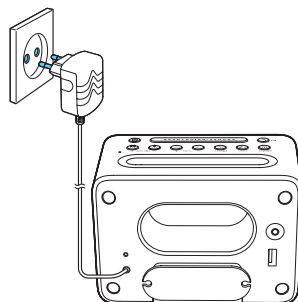

Turn on

Press \odot to turn on the clock radio.

- ↳ The clock radio switches to FM tuner source.
- To select another source, press \odot repeatedly to switch to Bluetooth, FM, or Aux mode.

Switch to standby mode

Press \odot repeatedly to switch to standby mode.

* Tip

- If the system is idle for 15 minutes, this product switches to standby mode automatically.

4 Set time and alarm

Set time

Note

- You can only set time in standby mode.

- 1 Press and hold **SET TIME** for two seconds to activate time setting mode.
↳ The hour and minute digits blink.
- 2 Press **HR** repeatedly to set hour.
- 3 Press **MIN** repeatedly to set minute.
- 4 Press **SET TIME** to confirm.
↳ The set time is displayed.

Note

- If the clock radio is idle for 10 seconds, it exits time setting mode automatically.

Set alarm timer

You can set two alarms to ring at different time.

Note

- You can only set the alarm in standby mode.
- Make sure that you have set the clock correctly.

- 1 Press and hold **AL1** or **AL2** for two seconds to activate alarm setting mode.
↳ The hour and minute digits blink.
- 2 Press **HR** repeatedly to set the hour.
- 3 Press **MIN** repeatedly to set the minute.
- 4 Press **AL1** or **AL2** to confirm.

- 5 Press **HR** or **MIN** to select an alarm source: FM radio or buzzer.
- 6 Press **AL1** or **AL2** again to confirm the alarm settings.

Note

- If the clock radio is idle for 10 seconds, it exits alarm setting mode automatically.

Activate or deactivate the alarm timer

Press **AL1** or **AL2** repeatedly to activate or deactivate the alarm timer:

- ↳ If the alarm timer is activated, [**AL1**] or [**AL2**] icon is displayed.
- ↳ If the alarm timer is deactivated, the alarm icon disappears.
 - To stop the ringing alarm, press the corresponding **AL1/AL2**.
 - ↳ The alarm repeats itself in subsequent days.

Note

- The alarm volume is not adjustable, but it will go up gradually to gently wake you up.

Snooze the alarm

When the alarm goes off, press **SNOOZE**.

- ↳ The alarm snoozes and repeats ringing nine minutes later.

5 Listen to FM radio

Prepare FM antenna

For better reception, fully extend and adjust the position of the pig-tail antenna.

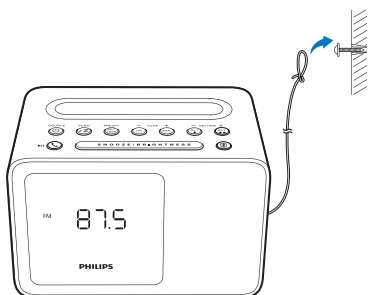

Note

- To prevent interference, position the antenna as far as possible from any other electrical appliances.

Tune to FM radio stations

- 1 Press **SOURCE** repeatedly to switch to FM tuner mode.
- 2 Press and hold **TUNE -** or **TUNE +** for two seconds.
 - ↳ The clock radio tunes to a station with strong reception automatically.
- 3 Repeat step 2 to tune to more radio stations.

To tune to a station manually:

In tuner mode, press **TUNE -** or **TUNE +** repeatedly to select a frequency.

Store FM radio stations automatically

In FM tuner mode, press and hold **SCAN** for two seconds.

- ↳ All available FM radio stations are stored automatically.
- ↳ The first stored radio station broadcasts.

Store FM radio stations manually

You can store up to 20 FM radio stations.

- 1 Tune to an FM radio station.
- 2 Press and hold **PRESET** for two seconds.
 - ↳ The preset number begins to blink.
- 3 Press **TUNE -** or **TUNE +** to select a number.
- 4 Press **PRESET** again to confirm.
- 5 Repeat steps 1 to 4 to store other stations.

Tip

- To remove a pre-stored station, store another station in its place.

Select a preset radio station

In tuner mode, press **PRESET** repeatedly to select a preset station.

6 Use Bluetooth devices

With this clock radio, you can listen to audio from Bluetooth-enabled devices and control the incoming call through Bluetooth.

Connect a device

Note

- Make sure that your Bluetooth device is compatible with this product.
- Before pairing a device with this product, read its user manual for Bluetooth compatibility.
- This product can memorize a maximum of 4 paired devices. The fifth paired device will replace the first one.
- Make sure that Bluetooth function is enabled on your device, and your device is set as visible to all other Bluetooth devices.
- The operational range between this product and a Bluetooth device is approximately 10 meters (30 feet).
- Any obstacle between this product and a Bluetooth device can reduce the operational range.
- Keep away from any other electronic device that may cause interference.

- 1 Press **SOURCE** repeatedly to select Bluetooth mode.
↳ **[BT]** (Bluetooth) flashes on the display.
- 2 On your Bluetooth device, enable Bluetooth and search for Bluetooth devices (refer to the user manual of the device).
- 3 When **[Philips AJT5300]** is displayed on your device, select it to start pairing and connection. If necessary, enter default password "0000".

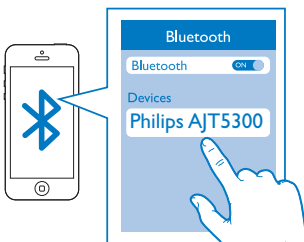

- If you cannot find **[Philips AJT5300]** for pairing, press and hold **Ⓚ** for two seconds to enter pairing mode, and then try again.
↳ After successful pairing and connection, **[BT]** (Bluetooth) stops flashing, and the clock radio beeps twice.

To disconnect the Bluetooth-enabled device:

- Press and hold **Ⓚ** for two seconds;
- Disable Bluetooth on your device; or
- Move the device beyond the communication range.

To connect another Bluetooth-enabled device:

- 1 Press and hold **Ⓚ** for two seconds to disconnect the currently connected device.
↳ The clock radio enters Bluetooth pairing mode.
- 2 Connect another Bluetooth device.

Bluetooth icon behavior	Description
Flashing quickly	Waiting for pairing
Flashing slowly	Connecting
Solid on	Connected

Play audio from Bluetooth-enabled device

After successful Bluetooth connection, play audio on the Bluetooth device.

- ↳ Audio streams from your Bluetooth device to the clock radio.
- You can press **▶|||** to start, pause or resume play.

Control your phone call

After Bluetooth connection, you can control your incoming phone call with this product.

Button	Function
	Press to answer an incoming call.
	During a call, press to end the current call.
	Press and hold for two seconds to reject an incoming call.

Note

- Music play pauses when there is an incoming call, and resumes when the call ends.

7 Other features

Charge your phone

With this clock radio, you can charge your phone through the USB socket.

- 1 Connect your phone and the clock radio with the charging cable of your phone (not supplied), as illustrated below.

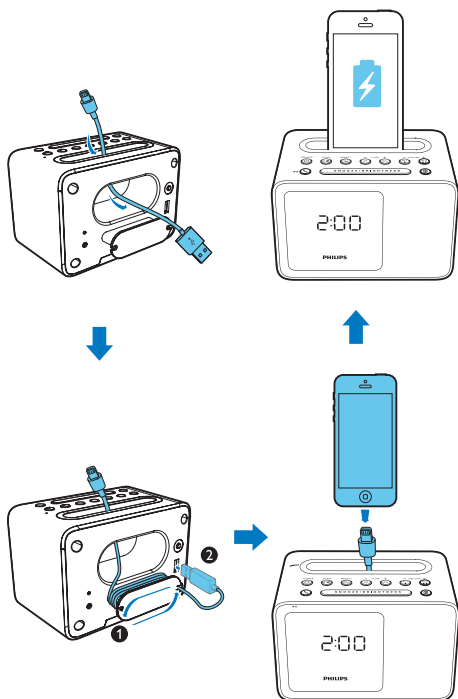

- 2 Connect the clock radio to AC power:
↳ The phone begins to charge.

Listen to an external device

With this clock radio, you can also listen to an external audio device such as an MP3 player.

- 1 Connect an audio input cable (not supplied) with a 3.5 mm connector on both ends to
 - the **AUDIO IN** socket on the clock radio, and
 - the headphone socket on the external device.

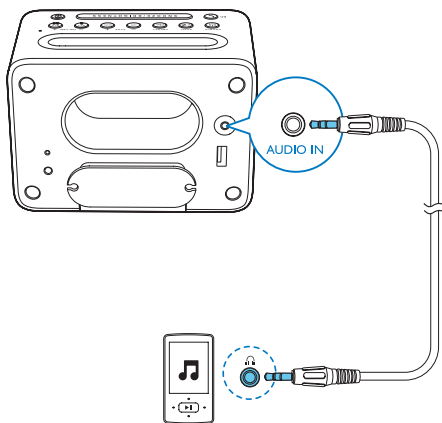

- 2 Press **SOURCE** repeatedly to select AUX source.
- 3 Play audio on the external device (refer to its user manual).

Set sleep timer

Press **zZ** repeatedly to select a period (in minutes).

- ↳ The clock radio switches to standby mode automatically after the preset period.

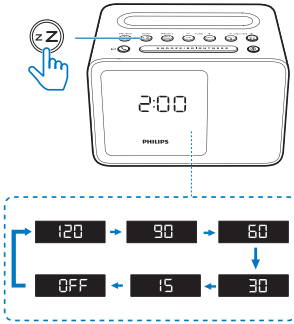

To deactivate the sleep timer:

- Press **zZ** repeatedly until **[OFF]** (off) appears.



Tip

- If you press **zZ** in standby mode, the clock radio will switch to FM tuner mode.

Adjust volume

While listening, press **-VOLUME +** to adjust volume.

Adjust display brightness

Press **BRIGHTNESS** repeatedly to select different brightness levels:

- High
- Medium
- Low

8 Specifications

Note

- Product information is subject to change without prior notice.

Rated output power (Amplifier):

2.7W RMS @ 10% THD

Acoustic frequency response:

200 Hz - 16 KHz

Speaker driver: 1 × 2", 4 Ω

Tuner frequency range: FM 87.5-108 MHz

Number of preset stations: 20

USB charging: 5 V, 1 A

Bluetooth version: V2.1+ EDR;

Supported Bluetooth profiles:

HFPV1.5, A2DPV1.2, AVRCPV1.0;

Bluetooth Operation Range:

10 m (Free space);

AC Power (Power Adapter)

Brand name: PHILIPS;

Model: S012B0502000E;

Input: 100-240V~, 50/60 Hz, max. 300mA;

Output: 5.0 V == 2000 mA;

Operation power consumption: 8.7 W

Standby power consumption: <1 W

Product dimensions – Main unit (W × H × D):

150 × 102 × 111 mm

Product weight: 0.5 kg

9 Troubleshooting



Warning

- Never remove the casing of this device.

To keep the warranty valid, never try to repair the system yourself.

If you encounter problems when using this device, check the following points before requesting service. If the problem remains unsolved, go to the Philips Web page (www.philips.com/support). When you contact Philips, make sure that the device is nearby and the model number and serial number are available.

General

No power

- Make sure that the AC power adaptor of the unit is connected properly.
- Make sure that there is power at the AC outlet.

No sound

- Adjust volume on the clock radio.
- Adjust volume on the Bluetooth-connected device.

No response from the unit

- Disconnect and reconnect the AC power plug, then turn on the unit again.

Cannot charge your phone

- Make sure that your phone is connected with the clock radio properly.
- Make sure that the clock radio is powered on.

Poor radio reception

- Keep the clock radio away from other electronic devices to avoid radio interference.
- Fully extend and adjust the position of the pig-tail antenna.

Alarm does not work

- Set the clock/alarm correctly.

Clock/alarm setting erased

- Power has been interrupted or the power plug has been disconnected.
- Reset the clock/alarm.

About Bluetooth device

The audio quality is poor after connection with a Bluetooth-enabled device.

- The Bluetooth reception is poor. Move the device closer to this product or remove any obstacle between them.

Cannot connect with the device.

- The Bluetooth function of the device is not enabled. Refer to the user manual of the device for how to enable the function.
- This product is already connected with another Bluetooth-enabled device. Disconnect that device and then try again.
- Press and hold **Ⓜ** for two seconds to enter pairing mode, and then try again.

The paired device connects and disconnects constantly.

- The Bluetooth reception is poor. Move the device closer to this product or remove any obstacle between them.
- For some devices, Bluetooth connection may be deactivated automatically as a power-saving feature. This does not indicate any malfunction of this product.

10 Notice

Any changes or modifications made to this device that are not expressly approved by Gibson Innovations may void the user's authority to operate the equipment. Hereby, Gibson Innovations declares that this product is in compliance with the essential requirements and other relevant provisions of Directive 2014/53/EU. You can find the Declaration of Conformity on www.philips.com/support.

Disposal of your old product



Your product is designed and manufactured with high quality materials and components, which can be recycled and reused.



This symbol on a product means that the product is covered by European Directive 2012/19/EU. Inform yourself about the local separate collection system for electrical and electronic products. Follow local rules and never dispose of the product with normal household waste. Correct disposal of old products helps prevent negative consequences for the environment and human health.

Environmental information

All unnecessary packaging has been omitted. We have tried to make the packaging easy to separate into three materials: cardboard (box), polystyrene foam (buffer) and polyethylene (bags, protective foam sheet.)

Your system consists of materials which can be recycled and reused if disassembled by a specialized company. Please observe the local regulations regarding the disposal of

packaging materials, exhausted batteries and old equipment.



This is CLASS II apparatus with double insulation, and no protective earth provided.



The Bluetooth® word mark and logos are registered trademarks owned by Bluetooth SIG, Inc. and any use of such marks by Gibson Innovations Limited is under license. Other trademarks and trade names are those of their respective owners.



Specifications are subject to change without notice.

Copyright © 2016 Gibson Innovations Limited. Revised Edition © 2017

This product has been manufactured by, and is sold under the responsibility of Gibson Innovations Ltd., and Gibson Innovations Ltd. is the warrantor in relation to this product.

Philips and the Philips Shield Emblem are registered trademarks of Koninklijke Philips N.V. and are used under license.

AJT5300_12_UM_V3.0

