

Register your product and get support at
www.philips.com/welcome

AJL303



Thank you for choosing Philips.

Need help fast?

Read your Quick Start Guide and/or User Manual first for quick tips that make using your Philips product more enjoyable.

If you have read your instructions and still need assistance, you may access our online help at

www.philips.com/welcome



Philips vous remercie de votre confiance.

Besoin d'une aide rapide?

Le Guide rapide de début et Manuel de l'utilisateur regorgent d'astuces destinées à simplifier l'utilisation de votre produit Philips.

Toutefois, si vous ne parvenez pas à résoudre votre problème, vous pouvez accéder à notre aide en ligne à l'adresse

www.philips.com/welcome



Gracias por escoger Philips

Necesita ayuda inmediata?

Lea primero la Guía rápida del comienzo o el Manual del usuario, en donde encontrará consejos que le ayudarán a disfrutar plenamente de su producto Philips.

Si después de leerlo aún necesita ayuda, consulte nuestro servicio de asistencia en línea en

www.philips.com/welcome



PHILIPS

1

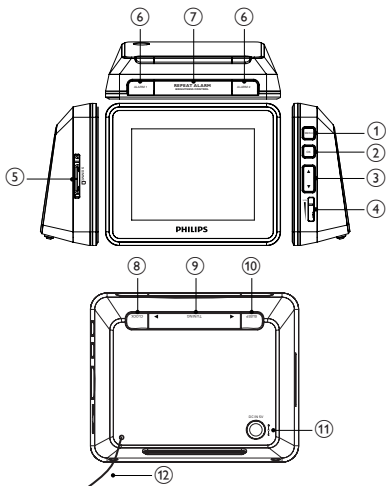

2

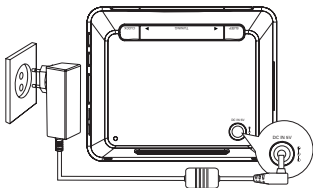

Canada

English:

This digital apparatus does not exceed the Class B limits for radio noise emissions from digital apparatus as set out in the Radio Interference Regulations of the Canadian Department of Communications. This Class B digital apparatus complies with Canadian ICES-003.

Français:

Cet appareil numérique n'émet pas de bruits radioélectriques dépassant les limites applicables aux appareils numériques de Classe B prescrites dans le Règlement sur le Brouillage Radioélectrique édicté par le Ministère des Communications du Canada. Cet appareil numérique de la classe B est conforme à la norme NMB-003 du Canada.

The set complies with the FCC-Rules, Part 15. Operation is subject to the following two conditions:

1. This device may not cause harmful interference, and
2. This device must accept any interference received, including interference that may cause undesired operation.

Return your Product Registration Card or register online at
www.philips.com/welcome today to get the very most from your purchase.

Registering your model with PHILIPS makes you eligible for all of the valuable benefits listed below, so don't miss out. Complete and return your Product Registration Card at once, or register online at www.philips.com/welcome to ensure:

*Proof of Purchase

Returning the enclosed card guarantees that your date of purchase will be on file, so no additional paperwork will be required from you to obtain warranty service.

*Product Safety Notification

By registering your product, you'll receive notification - directly from the manufacturer - in the rare case of a product recall or safety defect.

*Additional Benefits

Registering your product guarantees that you'll receive all of the privileges to which you're entitled, including special money-saving offers.

PHILIPS

Congratulations on your purchase, and welcome to the "family!"

Dear PHILIPS product owner:

Thank you for your confidence in PHILIPS. You've selected one of the best-built, best-backed products available today. We'll do everything in our power to keep you happy with your purchase for many years to come.

As a member of the PHILIPS "family," you're entitled to protection by one of the most comprehensive warranties and outstanding service networks in the industry. What's more, your purchase guarantees you'll receive all the information and special offers for which you qualify, plus easy access to accessories from our convenient home shopping network.

Most importantly, you can count on our uncompromising commitment to your total satisfaction.

All of this is our way of saying welcome - and thanks for investing in a PHILIPS product.

P.S. To get the most from your PHILIPS purchase, be sure to complete and return your Product Registration Card at once, or register online at:

www.philips.com/welcome

Know these

safety symbols



 This "bolt of lightning" indicates uninsulated material within your unit may cause an electrical shock. For the safety of everyone in your household, please do not remove product covering.

 The "exclamation point" calls attention to features for which you should read the enclosed literature closely to prevent operating and maintenance problems.

WARNING: To reduce the risk of fire or electric shock, this apparatus should not be exposed to rain or moisture and objects filled with liquids, such as vases, should not be placed on this apparatus.

CAUTION: To prevent electric shock, match wide blade of plug to wide slot, fully insert.

ATTENTION: Pour éviter les choc électriques, introduire la lame la plus large de la fiche dans la borne correspondante de la prise et pousser jusqu'au fond.

For Customer Use

Enter below the Serial No. which is located on the rear of the cabinet. Retain this information for future reference.

Model No. _____
Serial No. _____

PHILIPS

Visit our World Wide Web Site at <http://www.philips.com/welcome>

PHILIPS LIMITED WARRANTY ONE (1) YEAR

WARRANTY COVERAGE:

PHILIPS warranty obligation is limited to the terms set forth below.

WHO IS COVERED:

Philips warrants the product to the original purchaser or the person receiving the product as a gift against defects in materials and workmanship as based on the date of original purchase ("Warranty Period") from an Authorized Dealer. The original sales receipt showing the product name and the purchase date from an authorized retailer is considered such proof.

WHAT IS COVERED:

The Philips warranty covers new products if a defect in material or workmanship occurs and a valid claim is received by Philips within the Warranty Period. At its option, Philips will either (1) repair the product at no charge, using new or refurbished replacement parts, or (2) exchange the product with a product that is new or which has been manufactured from new, or serviceable used parts and is at least functionally equivalent or most comparable to the original product in Philips current inventory, or (3) refund the original purchase price of the product. Philips warrants replacement products or parts provided under this warranty against defects in materials and workmanship from the date of the replacement or repair for ninety (90) days or for the remaining portion of the original product's warranty, whichever provides longer coverage for you. When a product or part is exchanged, any replacement item becomes your property and the replaced item becomes Philips' property. When a refund is given, your product becomes Philips' property.

Note: Any product sold and identified as refurbished or renewed carries a ninety (90) day limited warranty.

Replacement product can only be sent if all warranty requirements are met. Failure to follow all requirements can result in delay.

WHAT IS NOT COVERED - EXCLUSIONS AND LIMITATIONS:

This Limited Warranty applies only to the new products manufactured by or for Philips that can be identified by the trademark, trade name, or logo affixed to it. This Limited Warranty does not apply to any non-Philips hardware product or any software, even if packaged or sold with the product. Non-Philips manufacturers, suppliers, or publishers may provide a separate warranty for their own products packaged with the bundled product.

Philips is not liable for any damage to or loss of any programs, data, or other information stored on any media contained within the product, or any non-Philips product or part not covered by this warranty. Recovery or reinstallation of programs, data or other information is not covered under this Limited Warranty.

This warranty does not apply (a) to damage caused by accident, abuse, misuse, neglect, misapplication, or non-Philips product, (b) to damage caused by service performed by anyone other than Philips or Philips Authorized Service Location, (c) to a product or a part that has been modified without the written permission of

Philips, or (d) if any Philips serial number has been removed or defaced, or (e) product, accessories or consumables sold "AS IS" without warranty of any kind by including refurbished Philips product sold "AS IS" by some retailers.

This Limited Warranty does not cover:

- Shipping charges to return defective product to Philips.
- Labor charges for installation or setup of the product, adjustment of customer controls on the product, and installation or repair of antenna/signal source systems outside of the product.
- Product repair and/or part replacement because of improper installation or maintenance, connections to improper voltage supply, power line surge, lightning damage, retained images or screen markings resulting from viewing fixed stationary content for extended periods, product cosmetic appearance items due to normal wear and tear, unauthorized repair or other cause not within the control of Philips.
- Damage or claims for products not being available for use, or for lost data or lost software.
- Damage from mishandled shipments or transit accidents when returning product to Philips.
- A product that requires modification or adaptation to enable it to operate in any country other than the country for which it was designed, manufactured, approved and/or authorized, or repair of products damaged by these modifications.
- A product used for commercial or institutional purposes (including but not limited to rental purposes).
- Product lost in shipment and no signature verification receipt can be provided.
- Failure to operate per Owner's Manual.

TO OBTAIN ASSISTANCE IN THE U.S.A., PUERTO RICO, OR U.S. VIRGIN ISLANDS...

Contact Philips Customer Care Center at:
1-888-PHILIPS (1-888-744-5477)

TO OBTAIN ASSISTANCE IN CANADA...

1-800-661-6162 (French Speaking)
1-888-PHILIPS (1-888-744-5477) - (English or Spanish Speaking)

REPAIR OR REPLACEMENT AS PROVIDED UNDER THIS WARRANTY IS THE EXCLUSIVE REMEDY FOR THE CONSUMER. PHILIPS SHALL NOT BE LIABLE FOR ANY INCIDENTAL OR CONSEQUENTIAL DAMAGES FOR BREACH OF ANY EXPRESS OR IMPLIED WARRANTY ON THIS PRODUCT. EXCEPT TO THE EXTENT PROHIBITED BY APPLICABLE LAW, ANY IMPLIED WARRANTY OF MERCHANTABILITY OR FITNESS FOR A PARTICULAR PURPOSE ON THIS PRODUCT IS LIMITED IN DURATION TO THE DURATION OF THIS WARRANTY.

Some states do not allow the exclusions or limitation of incidental or consequential damages, or allow limitations on how long an implied warranty lasts, so the above limitations or exclusions may not apply to you.



This warranty gives you specific legal rights. You may have other rights which vary from state/province to state/province.

Philips, P.O. Box 671539, Marietta, GA. 30006-0026

3121 233 48802

1 Important

Important safety instructions

- ① Read these instructions.
- ② Keep these instructions.
- ③ Heed all warnings.
- ④ Follow all instructions.
- ⑤ Do not use this apparatus near water.
- ⑥ Clean only with dry cloth.
- ⑦ Do not block any ventilation openings. Install in accordance with the manufacturer's instructions.
- ⑧ Do not install near any heat sources such as radiators, heat registers, stoves, or other apparatus (including amplifiers) that produce heat.
- ⑨ Do not defeat the safety purpose of the polarized or grounding-type plug. A polarized  plug has two blades with one wider than the other. A grounding type plug has two blades and a third grounding prong. The wide blade or the third prong are provided for your safety. If the provided plug does not fit into your outlet, consult an electrician for replacement of the obsolete outlet.
- ⑩ Protect the power cord from being walked on or pinched, particularly at plugs, convenience receptacles, and the point where they exit from the apparatus.
- ⑪ Only use attachments/accessories specified by the manufacturer.
- ⑫ Use only with the cart, stand, tripod, bracket, or table specified by the manufacturer or sold with the apparatus. When a cart is used, use caution when 

moving the cart/apparatus combination to avoid injury from tip-over.

- ⑬ Unplug this apparatus during lightning storms or when unused for long periods of time.
- ⑭ Refer all servicing to qualified service personnel. Servicing is required when the apparatus has been damaged in any way, such as power-supply cord or plug is damaged, liquid has been spilled or objects have fallen into the apparatus, the apparatus has been exposed to rain or moisture, does not operate normally, or has been dropped.
- ⑮ Apparatus shall not be exposed to dripping or splashing.
- ⑯ Do not place any sources of danger on the apparatus (e.g. liquid filled objects, lighted candles).
- ⑰ This product may contain lead and mercury. Disposal of these materials may be regulated due to environmental considerations. For disposal or recycling information, please contact your local authorities or the Electronic Industries Alliance: www.eiae.org.

This user manual has been printed on non-polluting paper.

All unnecessary packaging has been omitted. We have tried to make the packaging easy to separate into three materials: cardboard (box), polystyrene foam (buffer) and polyethylene (bags, protective foam sheet.) Your system consists of materials which can be recycled and reused if disassembled by a specialized company.

This electronic equipment contains a large number of materials that can be recycled. If you are disposing of an old machine, please take it to a recycling center.

Please observe the local regulations regarding disposal of packaging materials, exhausted batteries and old equipment.

Notice

Any changes or modifications made to this device that are not expressly approved by Philips Consumer Electronics may void the user's authority to operate the equipment.

2 Your clock radio

Congratulations on your purchase, and welcome to Philips! To fully benefit from the support that Philips offers, register your product at www.philips.com/welcome.

Introduction

With this clock radio, you can enjoy FM radio as well as the audio and picture files stored in a memory card.

You can set two separate alarm timings. For the alarm sound, you can select the audio files stored in the internal memory or a memory card.

What's in the box

Check and identify the contents of your package:

- Main unit
 - AC power adaptor
 - User manual
 - Quick start guide
-

Overview of the main unit (see 1)

① MENU

- Access home menu.
- Access previous menu.

- ② **OK**
- Confirm an entry or a selection.
 - For clock: play/pause slideshow.
 - For radio: play/mute radio play.
 - For music: play/pause the selected item.
 - For photo slideshow: play/pause/zoom.

- ③ **▲, ▼**
- Move cursor up/down.
 - For clock/photo: rotate photo clockwise/anti-clockwise.
 - For radio: change preset number.
 - For music: select different play modes.

- ④ **VOL**
- Adjust the volume level.

- ⑤ **SD/MMC**
- SD/MMC card slot

- ⑥ **ALARM 1/ALARM 2**
- Set, activate or deactivate alarm.

- ⑦ **REPEAT ALARM/BRIGHTNESS CONTROL**
- Repeat the alarm.
 - Select display brightness level.

- ⑧ **CLOCK**
- Press to change clock position on the screen.
 - Press and hold to set clock.

- ⑨ **TUNING ◀▶**
- Tune to radio stations.
 - For photo/music: select the previous/next item.

- ⑩ **SLEEP**
- Set, activate or deactivate sleep timer.

- ⑪ **DC IN 5V**
- Power supply socket.

- ⑫ **Antenna**

3 Get started



Caution

- Use the controls only as stated in this user manual.

Always follow the instructions in this chapter in sequence. If you contact Philips, you will be asked for the model and serial number of your clock radio. The model number and serial number are on the back of your clock radio. Write the numbers here:

Model No. _____

Serial No. _____

Connect power



Caution

- Risk of electric shock! When you disconnect the power supply, always pull the plug from the socket. Never pull the cord.
- Connect the supplied AC adaptor to the set and to the AC outlet. (see [2](#))

Select on-screen display language

- 1 Press **MENU**.
↳ The home menu appears.
- 2 Select **[Settings]**, then press **OK**.
↳ The setting menu appears.
- 3 Select **[Language]**, then press **OK**.
- 4 Select an option, then press **OK** to confirm.

- 5 Press **MENU** to exit the setting menu.
-

Set time and date

- 1 Press **MENU**.
- 2 Select **[Settings]** -> **[Clock]** -> **[Set time]**, then press **OK**.
- 3 Press **▲▼** to set the hour, then press **OK** to confirm.
- 4 Press **▲▼** to set the minute, then press **OK** to confirm.
- 5 Select **[Set date]**, then press **OK**.
- 6 Press **▲▼** to set the day, then press **OK** to confirm.
- 7 Press **▲▼** to set the month, then press **OK** to confirm.
- 8 Press **▲▼** to set the year, then press **OK** to confirm.
- 9 Press **MENU** to exit the setting menu.

4 Use your clock radio

Display clock

- 1 Press **MENU**.
- 2 Select **[Clock]**, then press **OK**.
 - ↳ The current time and alarm status are displayed on a background of photos from the internal memory.
 - To stop the slideshow, press **OK**. Press again to resume slideshow.
 - To change the background photo, press **TUNING ◀▶**.
 - To change the clock position on the screen, press **CLOCK**.

Listen to FM radio

- 1 Press **MENU**, then select **[Radio]**.
- 2 Press **TUNING ◀▶** to tune to a radio station.

To search for a radio station automatically:

- 1 Press and hold **TUNING** ◀/▶.
 - ↳ The radio tunes to a station with strong reception automatically.
- 2 Repeat step 1 if necessary until you find the desired station.
 - To tune to a weak station, press **TUNING** ◀▶ until you have found optimal reception.



Tip

- Extend or adjust the antenna for optimum reception.

Turn off radio

To turn off the radio, press **OK**. Press again to turn on the radio.

Program radio stations

You can store up to 20 FM radio stations in the memory manually or automatically.

Manual programming

- 1 Tune to a station.
- 2 Press and hold **OK** for about 2 seconds.
 - ↳ The preset number flashes.
- 3 Press ▲▼ to allocate a number from 1-20 to this station.
- 4 Press **OK** to confirm.
- 5 Repeat steps 1-4 to store other stations.

Automatic programming

Automatic programming starts from preset 1. Any previous presets are erased.

- 1 Press **MENU**.
 - 2 Select **[Settings]** -> **[Auto tune]**, then press **OK**.
 - ↳ All available stations are programmed.
 - ↳ After all stations are stored, the first preset station automatically plays.
-

View photos

- 1 Insert an SD/MMC card into the **SD/MMC** card slot.
 - ↳ The home menu appears.
 - 2 Select **[Photo]** from the home menu.
 - ↳ Thumbnail previews of the photos stored in the card are displayed.
 - 3 Press **OK**.
 - ↳ A slideshow of the stored photos starts from the photo selected.
 - To pause, press **OK**. Press again to resume play.
 - To select the previous/next photo, press **TUNING** ◀▶.
 - To rotate clockwise, press ▼.
 - To rotate counter-clockwise, press ▲.
 - To display clock while viewing photos, press **CLOCK**.
-

Listen to SD/MMC card audio

- 1 Insert an SD/MMC card into the **SD/MMC** card slot.
 - ↳ The home menu appears.
- 2 Select **[Music]** from the home menu.

3 Select a folder/file, then press **OK**.

↳ The file is played.

- To pause, press **OK**. Press again to resume play.
- To select the previous/next item, press **TUNING** ◀▶.
- To select different play modes: Repeat one, Repeat all, and shuffle, press ▲▼.
- To set the current music as sleep music, press and hold **SLEEP**.

Set the alarm timer



Note

- Before you start, ensure that the clock is set correctly.

You can set two separate alarm timings. For the alarm sound, you can select the audio files stored in the internal memory or a memory card.

1 Press **ALARM 1/ALARM 2**.

↳ The Alarm 1/ALarm 2 icon and the clock digits are displayed

2 Press ▲▼ to set the hour, then press **OK** to confirm.

3 Press ▲▼ to set the minute, then press **OK** to confirm.

↳ At the set time, the alarm sounds and the volume increase gradually.

Stop the alarm

- When the alarm sounds, press any button except **REPEAT ALARM/BRIGHTNESS CONTROL**.

Repeat the alarm

- When the alarm sounds, press **REPEAT ALARM/BRIGHTNESS CONTROL**.
 - ↳  flashes.
 - ↳ The alarm repeats once every 9 minutes.
-

Switch off the alarm

- To switch off the alarm, press **ALARM 1/ALARM 2** repeatedly until  changes to .



Tip

- When the alarm sounds, if no button is pressed, the alarm continues for 30 minutes.
-

Set sleep timer

The clock radio can switch to standby automatically after a set period of time (measured in minutes). You can select the audio that is activated during this period.

Activate radio

- 1 Tune to a radio station.
 - 2 Press **SLEEP** repeatedly to select a time.
 - ↳ The radio turns off after the set period of time.
-

Activate SD/MMC card audio

- 1 Repeat steps 1-3 (see 'Listen to SD/MMC card audio').
- 2 Press **SLEEP** repeatedly to select a time.
 - ↳ The audio play stops after the set period of time.

Activate preset sleep music

- 1 In clock or photo mode, press **SLEEP** repeatedly to select a time.
 - 2 Press ▲▼ to select sleep music.
 - [Relaxation 1]
 - [Relaxation 2]
 - [Relaxation 3]
- ↳ The music play stops after the set period of time.
-

Deactivate sleep timer

- Press **SLEEP** repeatedly until **[OFF]** is displayed.

5 Adjust settings

Change time format

- 1 Press **MENU**.
 - 2 Select **[Settings]** -> **[Clock]** -> **[Format]**.
 - 3 Press **OK** to toggle between **[12 hour]** and **[24 hour]**.
 - 4 Select **[Date format]**.
 - 5 Press **OK** to toggle between **[DD - MM - YYYY]** and **[YYYY - MM - DD]**.
-

Select clock style

- 1 Press **MENU**.
- 2 Select **[Settings]** -> **[Clock style]**.
- 3 Press **OK**, then select an option.
 - **[Format]**: select digital or analog clock
 - **[Color]**: select clock color
- 4 Press **MENU** to exit the setting menu.



Tip

- If you select analog clock, the clock color remains white when it is in the middle of the screen.

Select alarm music and photo

- 1 Press **MENU**.
- 2 Select **[Settings]** -> **[Alarm 1]/[Alarm 2]**.
- 3 Press **OK**, then select an option.
 - **[Alarm music]**: select alarm music.
 - **[Alarm photo]**: select alarm photo.



Tip

- In photo or music mode, press and hold **ALARM 1/ALARM 2** to save the current photo/music as the alarm photo/music.

Activate auto dim timer

- 1 Press **MENU**.
- 2 Select **[Settings]** -> **[Auto dim timer]** -> **[Auto dim]**.
- 3 Press **OK** to select **[ON]**.
- 4 Select **[Start]**, then press **OK**.
- 5 Press **▲▼** to set the hour, then press **OK** to confirm.
- 6 Press **▲▼** to set the minute, then press **OK** to confirm.
 - ↳ The time at which auto dim starts is set.
- 7 Select **[End]**.
- 8 Repeat steps 5-6 to set the end time.
 - ↳ The time at which auto dim ends is set.

Select slideshow settings

- 1 Press **MENU**.
 - 2 Select **[Settings]** -> **[Slideshow]**.
 - 3 Press **OK**, then select an option.
 - **[Slideshow sequence]**: display photos sequentially or randomly
 - **[Slideshow effect]**: select slideshow effects
 - **[Slideshow frequency]**: select slideshow intervals.
-

Play photo with music

- 1 Press **MENU**.
 - 2 Select **[Settings]** -> **[Photo with music playback]**.
 - 3 Press **OK** to select **[ON]**.
-

Restore original settings

- 1 Press **MENU**, then select **[Settings]** -> **[Restore default settings]**.
- 2 Press **OK**.
 - ↳ A confirmation box is displayed.

6 Product information



Note

- Product information is subject to change without prior notice.

AC power	Input: 100 - 240 V, 50/60 Hz Output: 5 V, 800 mA
Power consumption	4 W
Standby power consumption	<0.45 W
Dimensions - Main unit (W x H x D)	100 x 82 x 33 mm
Weight - With packing - Main unit	385 g 137 g
Tuning range	87.5-108 MHz
Tuning grid	100 KHz

7 Troubleshooting



Caution

- Never remove the casing of this clock radio.

To keep the warranty valid, never try to repair the system yourself. If you encounter problems when using this clock radio, check the following points before requesting service. If the problem remains unsolved, go to the Philips web site (www.Philips.com/support). When you contact Philips, ensure that your clock radio is nearby and the model number and serial number are available (see 'Get started').

No power

- Ensure that the AC power adaptor is connected properly.
- Ensure that there is power at the AC outlet.

No sound

- Adjust the volume.

Poor radio reception

- Fully extend the antenna.

Timer does not work

- Set the clock correctly.
- Switch on the timer.

Clock/timer setting erased

- Power has been interrupted or the power adaptor has been disconnected.
- Reset the clock/timer.

Philips Consumer Lifestyle

A Division of Philips Electronics North America Corporation
P.O. BOX 671539, Marietta, GA. 30006-0026

Meet Philips at the Internet

<http://www.philips.com/welcome>



Printed in China

PDCC-SY/ZYL-0839