

Register your product and get support at
www.philips.com/welcome

AJ7034D



EN User manual

PHILIPS

Contents

1 Important	3
Safety	3

2 Your Docking Entertainment System	4
Introduction	4
What's in the box	4
Overview of the main unit	5

3 Get started	6
Install battery	6
Connect power	6
Switch to standby mode	6
Set time and date	6

4 Play from iPod/iPhone	7
Compatible iPod/iPhone	7
Install application	7
Play from iPod/iPhone	8
Charge the iPod/iPhone	9
Adjust volume	9
Remove the iPod/iPhone	9

5 Listen to radio	10
Tune to FM radio stations	10

6 Other features	10
Set alarm timer	10
Set sleep timer	11
Play from an external device	11
Adjust display brightness	11

7 Product information	11
Specifications	11

8 Troubleshooting	12
--------------------------	-----------

9 Notice	13
-----------------	-----------

1 Important

Safety

- Heed all warnings.
- Follow all instructions.
- Do not use the clock radio near water.
- Clean only with dry cloth.
- Do not block any ventilation openings. Install in accordance with the manufacturer's instructions.
- Do not install near any heat sources such as radiators, heat registers, stoves, or other devices (including amplifiers) that produce heat.
- Protect the power cord from being walked on or pinched, particularly at plugs, convenience receptacles, and the point where they exit from the clock radio.
- Only use attachments/accessories specified by the manufacturer.
- Unplug the clock radio during lightning storms or when unused for long periods of time.
- Refer all servicing to qualified service personnel. Servicing is required when the apparatus has been damaged in any way, such as power-supply cord or plug is damaged, liquid has been spilled or objects have fallen into the apparatus, the apparatus has been exposed to rain or moisture, does not operate normally, or has been dropped.
- Battery usage CAUTION – To prevent battery leakage which may result in bodily injury, property damage, or damage to the clock radio:
 - Install the battery correctly, + and - as marked on the clock radio.
 - Remove battery when the clock radio is not used for a long time.
- The clock radio shall not be exposed to dripping or splashing.

- Do not place any sources of danger on the clock radio (e.g. liquid filled objects, lighted candles).
- Where the plug of the Direct Plug-in Adapter is used as the disconnect device, the disconnect device shall remain readily operable.



Warning

- Never remove the casing of this clock radio.
- Never lubricate any part of this clock radio.
- Never place this clock radio on other electrical equipment.
- Keep this apparatus away from direct sunlight, naked flames or heat.
- Ensure that you always have easy access to the power cord, plug or adapter to disconnect this clock radio from the power.

2 Your Docking Entertainment System

Congratulations on your purchase, and welcome to Philips! To fully benefit from the support that Philips offers, register your product at www.philips.com/welcome.

If you contact Philips, you will be asked for the model and serial number of this apparatus. The model number and serial number are on the bottom of the clock radio. Write the numbers here:

Model No. _____

Serial No. _____

Introduction

With this clock radio, you can

- listen to FM radio;
- enjoy audio from iPod/iPhone or an external device;
- choose buzzer, radio, or audio in iPod/iPhone as your alarm source.

What's in the box

Check and identify the contents of your package:

- Main unit (with battery)
- Quick start guide

Overview of the main unit

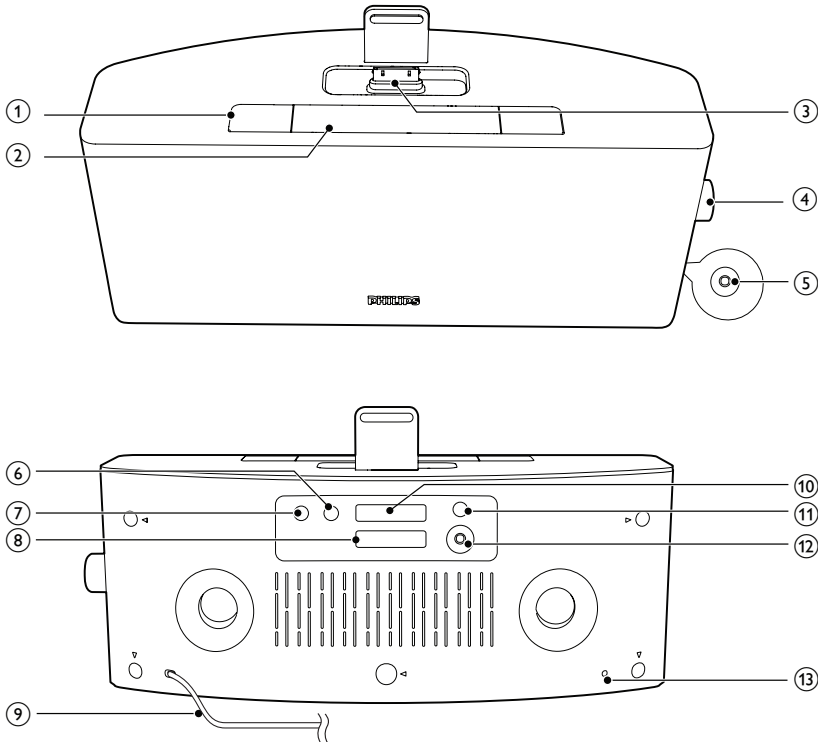

- ① **AL1/AL2**
 - Set alarm.
 - View alarm settings.
 - Activate/deactivate alarm timer.
- ② **SNOOZE/BRIGHTNESS**
 - Snooze alarm.
 - Adjust display brightness.
- ③ **DOCK**
 - Dock for iPod/iPhone.
- ④ **Volume knob**
 - Rotate to adjust volume or time.
 - Press to confirm a selection.
- ⑤ ①
 - Turn on/off the clock radio.
- ⑥ **SLEEP**
 - Set sleep timer.
- ⑦ **SOURCE**
 - Select source.
- ⑧ **Battery tray**
- ⑨ **Power cord**
- ⑩ ◀◀ / ▶▶
 - Tune or scan to an FM radio station.
- ⑪ **SET TIME**
 - Set the time.
- ⑫ **MP3 LINK**
 - Connect an external audio device.
- ⑬ **FM AERIAL**
 - Improve FM reception.

3 Get started

! Caution

- Use of controls or adjustments or performance of procedures other than herein may result in hazardous radiation exposure or other unsafe operation.

Always follow the instructions in this chapter in sequence.

Install battery

! Caution

- Risk of explosion! Keep batteries away from heat, sunshine, or fire. Never discard batteries in fire.
- Danger of explosion if battery is incorrectly replaced. Replace only with the same or equivalent type.
- The battery contains chemical substances, so it should be disposed of properly.
- Keep children away from the battery.
- Perchlorate Material - special handling may apply. See www.dtsc.ca.gov/hazardouswaste/perchlorate.

≡ Note

- You can only use AC power as power supply. The pre-installed lithium CR2032 battery can only back up time and alarm.

For first-time use:

Remove the protective tab to activate the battery.

To replace the battery:

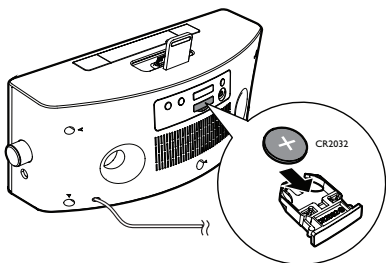

Connect power

! Caution

- Risk of product damage! Make sure that the power voltage corresponds to the voltage printed on the back or underside of the unit.
- Risk of electric shock! When you unplug the power adapter, always pull the plug from the socket. Never pull the cord.
- Before connecting the power adapter, make sure that you have completed all other connections.
- Use the supplied power adapter only.

Insert the power plug into the wall outlet.

- ↳ The clock radio switches to the last selected source.

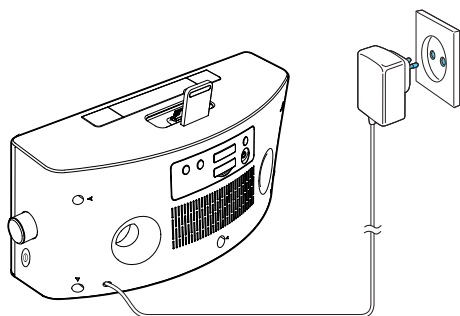

Switch to standby mode

Press **⏻** to switch the clock radio to standby mode.

- ↳ The clock (if set) is displayed on the display panel.

Set time and date

- 1 Press and hold **SET TIME** on the back of your clock radio for more than two seconds.

- ↳ [12H] or [24H] begins to blink.

- 2 Rotate the knob to select 12/24 hour format.
- 3 Press the knob to confirm.
↳ The hour digits begin to blink.
- 4 Repeat steps 2-3 to set hour and minute.

Note

- If clock is not manually set, when iPod/iPhone is connected, the unit synchronizes time from the iPod/iPhone automatically.

Tip

- The accuracy of the transmitted time depends on the docked iPod/iPhone that transmits the time signal.

4 Play from iPod/iPhone

You can enjoy audio from iPod/iPhone through this clock radio.

Compatible iPod/iPhone

The unit supports the following iPod, iPhone models:

Made for:

- iPod touch (1st, 2nd, 3rd, and 4th generation)
- iPod nano (1st, 2nd, 3rd, 4th, 5th, and 6th generation)
- iPhone 4
- iPhone 3GS
- iPhone 3G
- iPhone

Install application

- 1 Press **SOURCE** repeatedly to select DOCK mode.
- 2 Insert the iPod/iPhone into the dock.
- 3 For the first-time use, you will be asked to install an application in your iPod/iPhone.
 - Click **Yes** to install the application.

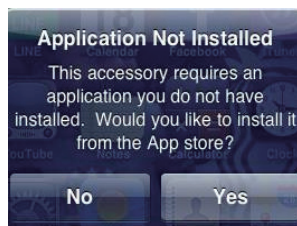

Play from iPod/iPhone

Note

- Make sure that you have installed the application in your iPod/iPhone.

- 1 Click home audio icon on your iPod/iPhone.
 - ↳ The setting page appears.
 - Click setting button on the bottom right corner, and you can set the clock, sleep timer, and alarm for your clock radio.



- 2 Slide to previous page to play music from your iPod/iPhone.

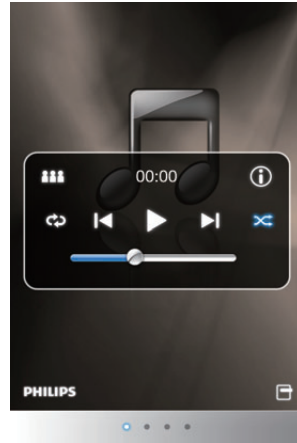

- 3 Slide to the third page to reset radio stations.
 - ① Press </> to tune to a radio station.
 - ② Press SAVE, and then press a preset number.
 - ↳ SAVE and the selected preset number are activated (in blue).
 - ↳ The radio station is saved successfully.
 - ③ If SAVE is activated, you can tune to other stations, and press a number to save stations directly.

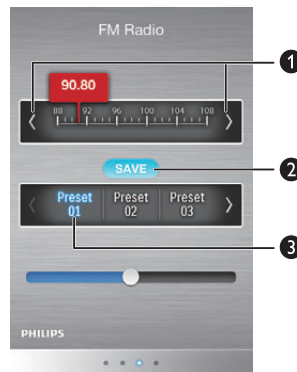

Note

- If you don't need to preset more stations, press **SAVE** again to make sure that the **SAVE** button is deactivated (in gray).

- 4 Slide to the following page. You can:
- set the theme;
 - share the information;
 - set the location for weather report;
 - choose temperature unit;
 - turn on or off month/day revert;
 - search for radio stations automatically by pressing **Radio Auto Program** (radio auto program) to activate automatic programming.
 - ↳ **[Searching]** (searching) is displayed.
 - ↳ All available stations are programmed in the order of waveband reception strength.
 - ↳ The first programmed radio station is broadcast automatically.

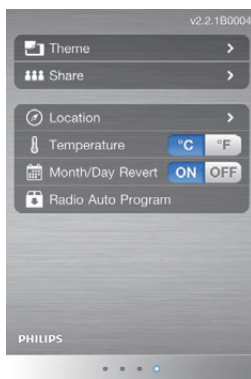

Adjust volume

During play, you can rotate the knob to adjust volume.

Remove the iPod/iPhone

Pull the iPod/iPhone out of the dock.

Charge the iPod/iPhone

When your clock radio is connected to power, the docked iPod/iPhone begins to charge automatically.

5 Listen to radio

Note

- Keep the unit away from other electronic devices to avoid radio interference.
- For better reception, do not place iPod/iPhone into the dock when you listen to the radio. Fully extend and adjust the position of the FM aerial.

Tune to FM radio stations

You also can tune to radio stations from your clock radio.

- 1** Press **SOURCE** repeatedly to select FM tuner.
- 2** Press and hold **◀◀ / ▶▶** on the back of your clock radio for more than two seconds.
 - ↳ The first programmed radio station is broadcast automatically.
- 3** Repeat step 2 to tune to more stations.

To tune to a station manually:

Press **◀◀ / ▶▶** repeatedly until you find optimal reception.

6 Other features

Set alarm timer

Set alarm

Note

- Make sure that you have set the clock correctly.

You can set two alarms to ring at different time.

- 1** Press and hold **AL1/AL2** for more than two seconds to activate alarm setting mode.
 - ↳ The hour digits and alarm icon begin to blink.
- 2** Rotate the knob to set the hour.
- 3** press the knob to confirm.
 - ↳ The minute digits begin to blink.
- 4** Repeat steps 2-3 to set the minute, select an alarm source (buzzer, radio, or dock), and adjust the volume.

Note

- When alarm time comes, the selected buzzer, radio, or iPod/iPhone turns on.
- You can only select the same alarm source for Alarm 1 and Alarm 2.
- If iPod/iPhone is selected, but no iPod/iPhone is connected, the clock radio switches to buzzer source instead.

Activate/deactivate alarm timer

- 1** Press **AL1/AL2** to view alarm settings.
- 2** Press **AL1/AL2** again to activate or deactivate the alarm timer.

- ↳ 1 or 2 is displayed if alarm timer is on and disappears if it is off.
- To stop the ringing alarm, press the corresponding **AL1/AL2**.
- ↳ The alarm repeats ringing for the next day.

Snooze alarm

When alarm sounds, press **SNOOZE**.

- ↳ The alarm snoozes and repeats ringing 9 minutes later.

Set sleep timer

This clock radio can switch to standby mode automatically after a preset period.

Press **SLEEP** repeatedly to select the sleep timer period (in minutes).

- ↳ When the sleep timer is activated, **zZ** appears. To deactivate the sleep timer, press **SLEEP** repeatedly until clock time appears.

Play from an external device

You can also listen to an external audio device through this clock radio.

- 1 Press **SOURCE** to select the **AUX** source.
- 2 Connect the MP3 link cable (not supplied) to:
 - the **MP3-LINK** socket (3.5mm) at the back of your clock radio.
 - the headphone socket of an external device.
- 3 Start to play the device (see the user manual of the device).

Adjust display brightness

Press **BRIGHTNESS** repeatedly to select different brightness levels.

7 Product information



Note

- Product information is subject to change without prior notice.

Specifications

Amplifier

Rated Output Power	2 x 5 W RMS
Frequency Response	40-20000 Hz
Signal to Noise Ratio	>70 dB
Total Harmonic Distortion	<1%
Aux Input (MP3 link)	0.6 V RMS 10 k ohm

Tuner (FM)

Tuning range	87.5-108 MHz
Tuning grid	50 KHz
Sensitivity	
- Mono, 26 dB S/N Ratio	<22 dBf
- Stereo, 46 dB S/N Ratio	<46 dBf
Search Selectivity	30 dBf

Speakers

Speaker Impedance	4 ohm
Sensitivity	>82 dB/m/W

General information

AC power (power adapter)	Brand name: Philips; Model: YJS03- 1001800G; Input: 100-240 V~, 47- 63 Hz; 500 mA; Output: 10.0 V === 1800 mA;
Operation Power Consumption	<25 W
Standby Power Consumption	<1 W
Dimensions: Main Unit (W x H x D)	283 x 118 x 112 mm
Weight:	
-Main Unit	1.36 kg
-With Packing	1.75 kg

8 Troubleshooting



Warning

- Never remove the casing of this apparatus.

To keep the warranty valid, never try to repair the system yourself.

If you encounter problems when using this apparatus, check the following points before requesting service. If the problem remains unsolved, go to the Philips web site (www.philips.com/welcome). When you contact Philips, ensure that the apparatus is nearby and the model number and serial number are available.

No power

- Ensure that the AC power plug of the unit is connected properly.
- Ensure that there is power at the AC outlet.

No sound

- Adjust the volume.

No response from the unit

- Disconnect and reconnect the AC power plug, then turn on the unit again.

Poor radio reception

- Increase the distance between the unit and your TV or VCR.
- Fully extend the FM aerial.

Alarm does not work

- Set the clock/alarm correctly.

Clock/alarm setting erased

- Power has been interrupted or the power plug has been disconnected.
- Reset the clock/alarm.

9 Notice



This product complies with the radio interference requirements of the European Community.

Any changes or modifications made to this device that are not expressly approved by Philips Consumer Lifestyle may void the user's authority to operate the equipment.



Your product is designed and manufactured with high quality materials and components, which can be recycled and reused.



When this crossed-out wheeled bin symbol is attached to a product it means that the product is covered by the European Directive 2002/96/EC.

Please inform yourself about the local separate collection system for electrical and electronic products.

Please act according to your local rules and do not dispose of your old products with your normal household waste. Correct disposal of your old product helps to prevent potential negative consequences for the environment and human health.



Your product contains batteries covered by the European Directive 2006/66/EC, which cannot be disposed with normal household waste. Please inform yourself about the local rules on separate collection of batteries

because correct disposal helps to prevent negative consequences for the environmental and human health.

Environmental information

All unnecessary packaging has been omitted. We have tried to make the packaging easy to separate into three materials: cardboard (box), polystyrene foam (buffer) and polyethylene (bags, protective foam sheet.)

Your system consists of materials which can be recycled and reused if disassembled by a specialized company. Please observe the local regulations regarding the disposal of packaging materials, exhausted batteries and old equipment.

Made for



iPod



iPhone

"Made for iPod" and "Made for iPhone" mean that an electronic accessory has been designed to connect specifically to iPod or iPhone respectively, and has been certified by the developer to meet Apple performance standards. Apple is not responsible for the operation of this device or its compliance with safety and regulatory standards. Please note that the use of this accessory with iPod or iPhone may affect wireless performance. iPod and iPhone are trademarks of Apple Inc., registered in the U.S. and other countries. 2011 © Koninklijke Philips Electronics N.V. All rights reserved.

Specifications are subject to change without notice. Trademarks are the property of Koninklijke Philips Electronics N.V. or their respective owners. Philips reserves the right to change products at any time without being obliged to adjust earlier supplies accordingly.



Note

- The type plate is located on the bottom of the apparatus.



Specifications are subject to change without notice
© 2012 Koninklijke Philips Electronics N.V.
All rights reserved.

AJ7034D_12_UM_V2.0

