

PHILIPS

AJ 3150 Clock Radio

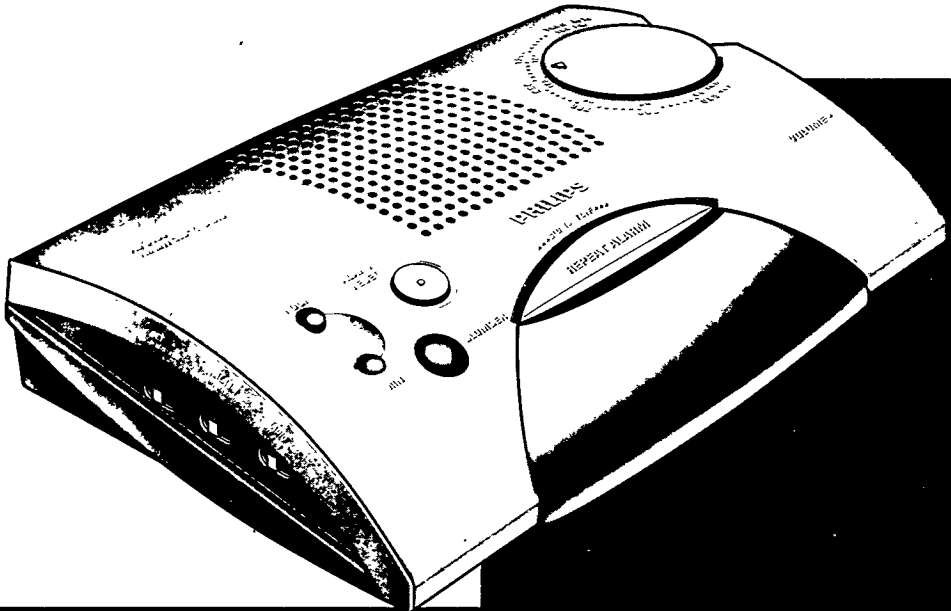

(E) España

Declaración de conformidad con normas
El que suscribe, en nombre y representación de:
Beijing Philips Audio/Video Corporation.

declara, bajo su propia responsabilidad, que el equipo:

Radio reloj
fabricado por: **Beijing Philips A/V Corp.**
en: **People's Republic of China**
marca: **Philips**
modelo: **AJ 3150**

objeto de esta declaración, cumple con la normativa siguiente: Reglamento sobre Perturbaciones Radioeléctricas, Real Decreto 138/1989, Anexo V.

Hecho en: **Beijing** 01-08-1994

Firma:

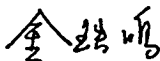

Nombre: **Jin Tieming**
Cargo: **Quality Manager**

(MEX) Mexico

NOM

Garantía.....Página 34

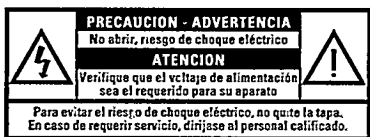

Es

necesario que lea cuidadosamente su instructivo de manejo.

(BR) Brasil

Garantía.....Página 34

(AUS) Australia

Guarantee.....Page 35

(NZ) New Zealand

Guarantee.....Page 35

(N) Norge

Typeskilt finnes på apparatens underside.

Observer

Nettbryteren er sekundert innkoplet. Den innbygde nettdelen er derfor ikke frakoplet nettet så lenge apparatet er tilsluttet nettkontakten.

(GB) English

page 4

English

(F) Français

page 7

Français

(E) Español

página 10

Español

(D) Deutsch

Seite 13

Deutsch

(NL) Nederlands

pagina 16

Nederlands

(I) Italiano

pagina 19

Italiano

(P) Português

página 22

Português

(DK) Dansk

side 25

Dansk

(S) Svenska

sida 28

Svenska

(FIN) Suomi

sivu 31

Suomi

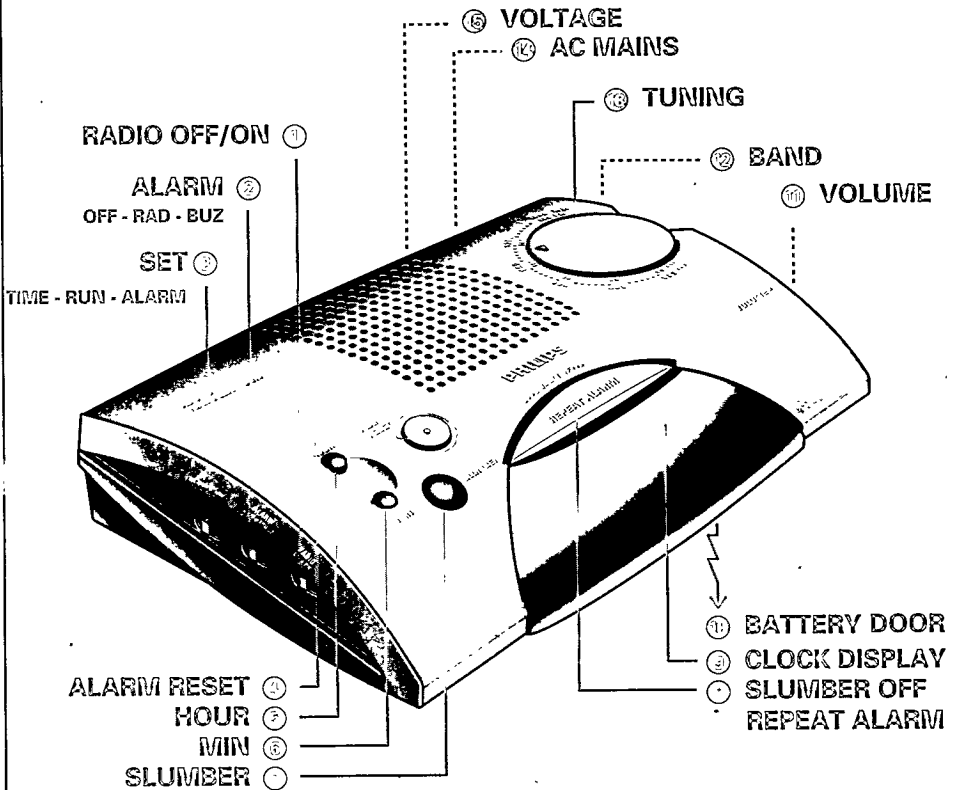

Installation

Radio/Clock

BUTTONS

- ① **RADIO** switch - to switch radio on/off
- ② **ALARM** switch:
 - **RAD** - for waking up by radio
 - **BUZ** - for waking up by buzzer
 - **OFF** - alarm off
- ③ **TIME SET** switch:
 - **TIME** - for setting the time
 - **RUN** - normal position
 - **ALARM** - for setting the alarm time
- ④ **ALARM RESET** button - to switch off the alarm for 24 hours
- ⑤ **HOUR** button - for setting the hours
- ⑥ **MINUTE** button - for setting the minutes
- ⑦ **SLUMBER** - To slumber/set slumber time
- ⑧ **SLUMBER OFF / REPEAT ALARM** button:
 - To switch off the alarm temporarily
 - To switch off the slumberfunction
- ⑨ **Clock display** with **ALARM-** and **PM-** indicator (not all versions)
- ⑩ **BATTERY** door
- ⑪ **VOLUME** control - for adjusting the volume
- ⑫ **BAND** switch - for selecting wavebands
- ⑬ **TUNING** dial - for locating the required station
- ⑭ **AC MAINS** - for connecting the mains lead
- ⑮ **VOLTAGE** selector (not on all versions)

MAINS CONNECTION

- Check if the mains voltage as shown on the type plate corresponds to your local mains supply. If it does not, consult your dealer or service organisation.
- If the set is equipped with a voltage selector, set this selector to the local mains voltage.
- Connect the mains lead to the AC MAINS socket and the wall socket. The mains supply is now switched on. As soon as the power plug is put into the wall outlet, the numbers on the display will start to flash. This means that you must set the correct time.
- To disconnect the set from the mains completely, withdraw the mains plug from the wall socket.

Important note for users in the U.K.

When fitting a mains plug, follow the instructions on page 6.

RADIO

RADIO ON

- Set the RADIO switch ① to ON.
- Select the waveband with the BAND ⑫ switch.
- Select the required station with the TUNING ⑬ knob.
- Adjust the sound level with the VOLUME ⑪ control.

RADIO OFF

Set the RADIO ① switch to OFF.

Aerials

- The AM aerial is built into the appliance. You may have to adjust the position of the clock radio slightly for better reception.
- For FM reception, there is an aerial wire at the rear of the clock radio. This wire must be extended and, if necessary adjusted slightly, in order to obtain good reception.

CLOCK

Clock display

The clock indicates the time on the display. In case of 12-hour clock system, the PM-indicator will light up (on=PM, off=AM). The ALARM indicator comes on when you switch on the alarm.

Adjusting the time

- Set the TIME SET switch ③ to TIME.
- Set the correct time using the MIN ⑥ and HOUR ⑤ buttons.
- Set the TIME SET switch ③ to RUN.

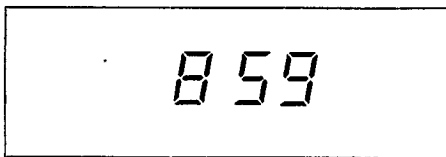

Alarm

SETTING THE ALARM TIME

Alarmtime

- Set the TIME SET switch ③ to ALARM.
- Set the correct alarmtime using the MIN ⑥ and HOUR ⑤ buttons.
- Set the TIME SET switch ③ to RUN.

ALARM ON

The clock radio can awaken you in 2 ways:

Wake by radio

- Make sure the volume of the radio is loud enough to wake you.
- Set ALARM switch ② to RAD.
- You will be awakened at the set alarm time by the radio.

Wake by buzzer

- Set ALARM switch ② to BUZ.
- At the set alarm time you will be awakened by the buzzer



9 00

ALARM OFF

You can switch off the alarm in 3 ways:

Switching off the alarm for 9 minutes

- Press the REPEAT ALARM button ⑧. With this switch you temporarily switch off the alarm. After nine minutes the alarm (radio or buzzer) will sound again. If you press the REPEAT ALARM button ⑧ again, the same will happen. If the REPEAT ALARM button ⑧ is not pressed again, the alarm will switch itself off after 1 hour and 59 minutes. The following day the alarm signal will sound again at the set alarm time.

Switching off the alarm for 24 hours

- Press the ALARM RESET button ④. The alarm is now switched off for 24 hours and will sound again the next day at the same time.

Switching off the alarm completely

- Set the ALARM switch ② to OFF. In the display the ALARM indicator will disappear and the alarm is now switched off. If you wish to be awakened the following day again, you must reset the ALARM switch ② to RAD or BUZ before going to sleep.

Slumbering

SLUMBER

The clock radio has a built-in slumber function ⑦, which enables you to listen to the radio before you fall asleep. You will not have to switch off the clock radio yourself as this will take place automatically after 59 minutes.

GB

SLUMBER ON

The time you listen to the radio before you fall asleep is called the slumber time. The slumber time is 59 minutes.

If you wish to slumber, carry out the following:

- Make sure the TIME SET switch ③ is set to RUN.
- Press the SLUMBER button ⑦. The display will show that you have a slumber time of 59 minutes.



59

SLUMBER OFF

You can switch off the radio before the slumber time has elapsed:

- Press the SLUMBER OFF/REPEAT ALARM button ③ and the radio is switched off.
 - If the TIME SET switch ③ is in position TIME or ALARM, the slumber function will not work.
 - The slumber function does not affect the alarm.

Additional

(GB)

POWER FAILURE

- As soon as a power failure occurs, the complete clock radio will be switched off.
- As soon as the power supply returns, the numbers on the display start to flash. This indicates that you must set the correct time on the clock.
- You can insert a 9 Volts pack battery (type 6F22) in the clock radio. Should there be a power failure, the clock will continue to function. You will not see this, however, — because the battery does not illuminate the clock display. As soon as the power is switched on again, the display will indicate the correct time. For clarity: Alarm, radio and display do not work on battery.
- Before inserting the battery, connect the power plug to the wall outlet.
- Place the battery in the compartment on the base of the clock radio
- Replace the battery once a year. It is not possible to say precisely how long the battery will last. The battery life time depends on how often and for how long the power supply fails. This varies according to country and region.

MAINTENANCE

- If you do not intend to use the clock radio for a long time, it is better to remove the plug from the wall socket. In addition to this, it is advisable to remove the battery from the clock radio. This will prevent any danger of leakage and the clock radio will not be damaged.
- Fingerprints, dust and dirt on the clock radio should be removed using a clean and damp soft cloth or chamois leather. When cleaning do not use any products which contain abrasive agents or solvents (benzine, thinner, alcohol etc.). These might affect the housing.
- Rain, dampness and extreme heat may damage the clock radio. For this reason it should not be placed in full sun or close to heating elements for any period of time.

This product complies with the radio interference requirements of the European Community

The type-plate is located on the base of the set.

IMPORTANT NOTES FOR USERS IN THE U.K.

Mains plug

This apparatus is fitted with an approved moulded 13 Amp plug. To change a fuse in this type of plug proceed as follows:

- Remove fuse cover and fuse.
- Fix new fuse which should be a BS1362 5 Amp, A.S.T.A. or BSI approved type.
- Refit the fuse cover.

If the fitted plug is not suitable for your socket outlets, it should be cut off and an appropriate plug fitted in its place.

If the mains plug contains a fuse, this should have a value of 5 Amp. If a plug without a fuse is used, the fuse at the distribution board should not be greater than 5 Amp.

Note: The severed plug must be disposed to avoid a possible shock hazard should it be inserted into a 13 Amp socket elsewhere.

How to connect a plug

The wires in the mains lead are coloured with the following code: blue = neutral (N), brown = live (L). As these colours may not correspond with the colour markings identifying the terminals in your plug, proceed as follows:

- Connect the blue wire to the terminal marked N or coloured blue or black.
- Connect the brown wire to the terminal marked L or coloured brown or red.
- Do not connect either wire to the earth terminal in the plug, marked E (or \perp) or coloured green (or green and yellow).

Before replacing the plug cover, make certain that the cord grip is clamped over the sheath of the lead - not simply over the two wires.

If in doubt, consult a qualified electrician.

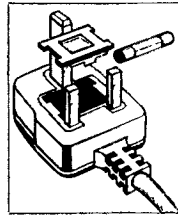



Australia

GUARANTEE FOR AUSTRALIA

The benefits given to the purchaser by this warranty are in addition to all other rights and remedies, which, under the Trade Practices Act or other Commonwealth or State law, the purchaser or owner has in respect of the product.

The Philips product carries the following warranties:

- C-series HiFi-systems 12 months.
- Compact Disc Players: 12 months.
- Home Audio Systems: 6 months.
- Clock radios, portable radios, cassette recorders, cassette players and radio recorders: 90 days.

Any defect in materials or workmanship occurring within the specified period from the date of delivery, will be rectified free of charge by the retailer from whom this product was purchased.

Note: Please retain your purchase docket to assist prompt service.

Conditions of this warranty

1. All claims for warranty service must be made to the retailer from whom this product was purchased. All transport charges incurred in connection with warranty service or replacement will be paid by the purchaser.
2. These warranties do not cover batteries and extend only to defects in materials or workmanship occurring under normal use of the product where operated in accordance with our instructions.

**Philips
Consumer Products Division
Technology Park
Figtree Drive, Australia Centre
Homebush 2140
New South Wales**



New Zealand

GUARANTEE FOR NEW ZEALAND

Thank-you for purchasing this quality Philips product.

Philips New Zealand Ltd guarantees this product against defective components and faulty workmanship for a period of 12 months. Any defect in materials or workmanship occurring within 12 months from the date of purchase subject to the following conditions will be rectified free of charge by the retailer from whom this product was purchased.

Conditions

1. The product must have been purchased in New Zealand. As proof of purchase, retain the original sales docket indicating the date of purchase.
2. The guarantee applies only to faults caused by defective components, or faulty workmanship on the part of the manufacturer.
3. The guarantee does not cover failures caused by misuse, neglect, normal wear and tear, accidental breakage, use on the incorrect voltage, use contrary to operating instructions, or unauthorised modification to the product or repair by an unauthorised technician.
4. Reasonable evidence (in the form of a sales docket) must be supplied to indicate that the product was purchased no more than 12 months prior to the date of your claim.
5. In the event of a failure, Philips shall be under no liability for any injury, or any loss or damage caused to property or products other than the product under guarantee.

This guarantee does not prejudice your rights under common law and statute, and is in addition to the normal responsibilities of the retailer and Philips.

How to claim

Should your Philips product fail within the guarantee period, please return it to the retailer from whom it was purchased. In most cases the retailer will be able to satisfactorily repair or replace the product.

However, should the retailer not be able to conclude the matter satisfactorily, or if you have other difficulties claiming under this guarantee, please contact

**The Guarantee Controller
Philips New Zealand Ltd.**

✉ P.O. Box 41.021

Auckland

☎ (09) 84 94 160

fax ☎ (09) 84 97 858

Mounting the set on a shelf

- Make two mounting holes on the shelf as indicated below.
- Mount the set on the shelf with two screws.

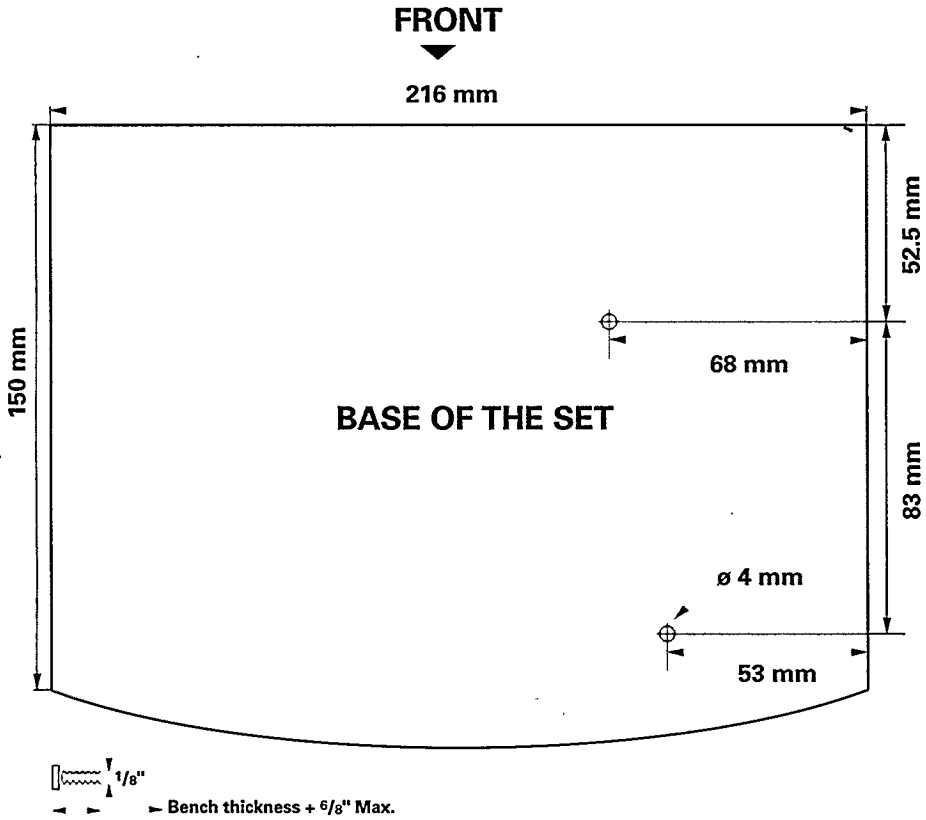

Philips - AJ 3150 - Clock radio

English

(GB) English

page 4

Français

(F) Français

page 7

Español

(E) Español

página 10

Deutsch

(D) Deutsch

Seite 13

Nederlands

(NL) Nederlands

pagina 16

Italiano

(I) Italiano

pagina 19

Português

(P) Português

página 22

Dansk

(DK) Dansk

side 25

Svenska

(S) Svenska

sida 28

Suomi

(FIN) Suomi

sivu 31

