

PHILIPS

AE 2340 Portable Digital Radio

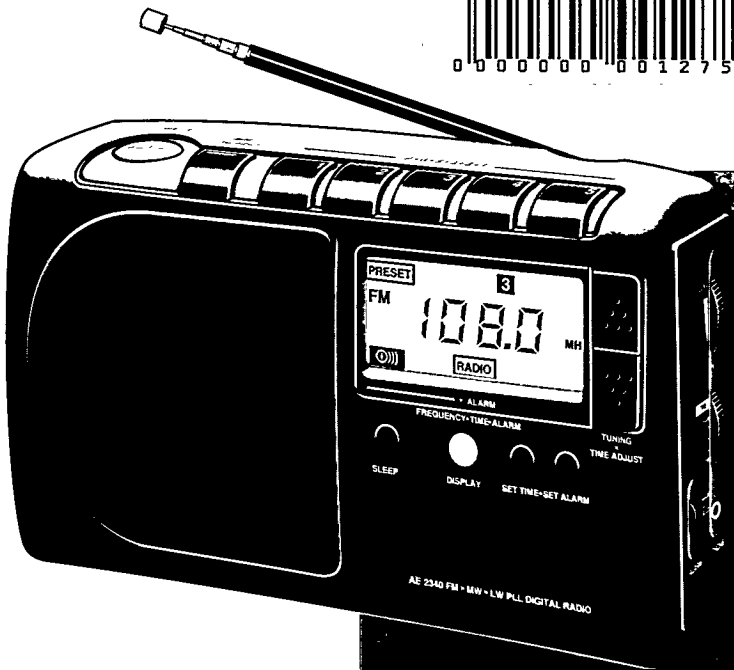

INDEX

(GB) English page 5

English

(F) Français page 10

Français

(E) Español página 15

Español

(D) Deutsch Seite 20

Deutsch

(NL) Nederlands pagina 25

Nederlands

(I) Italiano pagina 30

Italiano

(P) Português página 35

Português

(DK) Dansk side 40

Dansk

(S) Svenska sida 45

Svenska

(FIN) Suomi sivu 50

Suomi

(G) Ἑλληνικά σελίδα 55

Ἑλληνικά

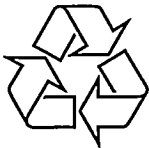

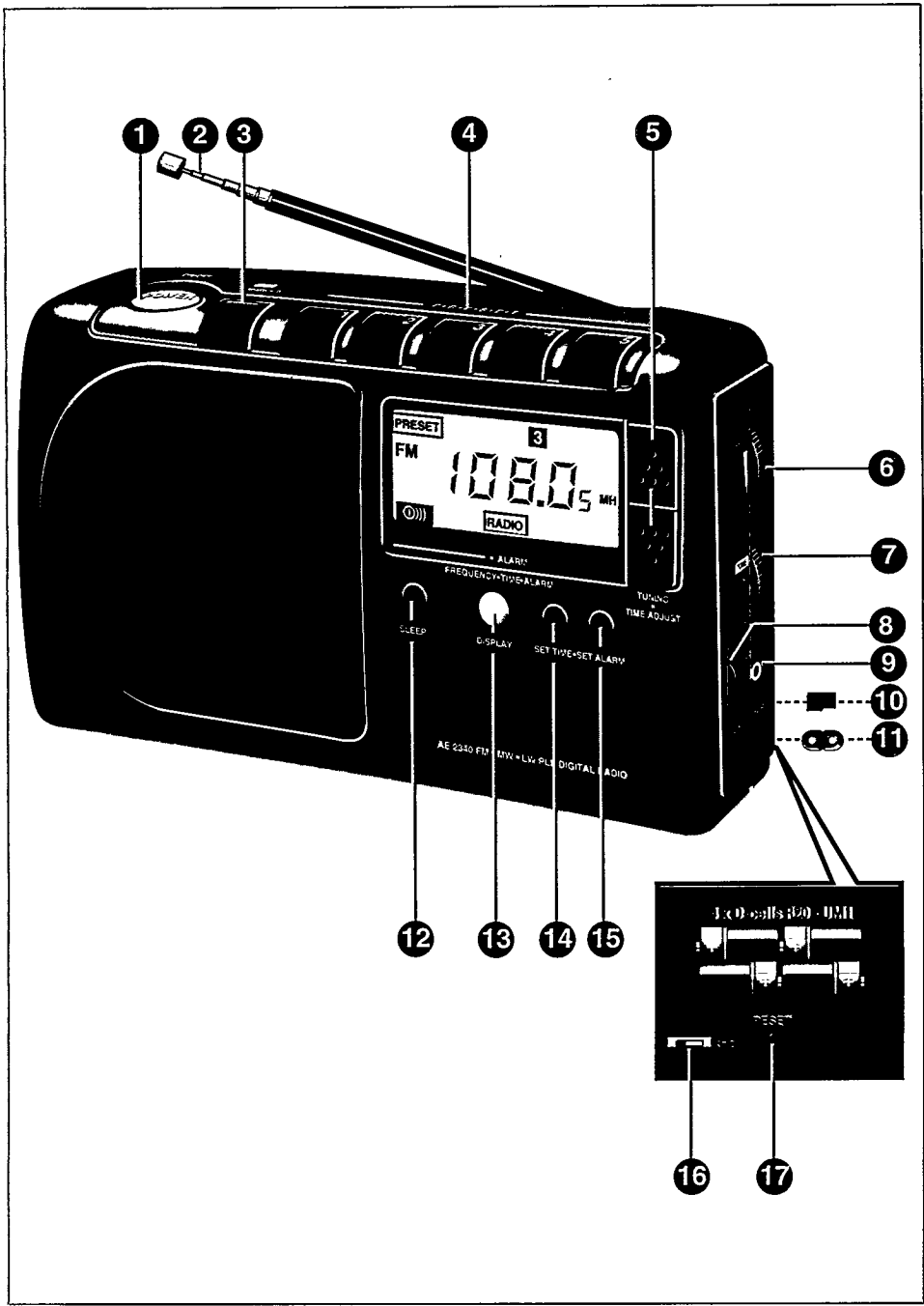

(E) España

Declaración de conformidad con normas

El que suscribe, en nombre y representación de:
**Product Group Portable Audio
Philips Hong Kong Ltd.**

declara, bajo su propia responsabilidad, que el

equipo: **Radio portátil**
fabricado por: **PGPA Philips HK Ltd**
en: **Far East**
marca: **Philips**
modelo: **AE 2340**

objeto de esta declaración, cumple con la normativa
siguiente: Reglamento sobre Perturbaciones Radio-
eléctricas, Real Decreto 138/1989, Anexo V.

Hecho en: **Hong Kong, 01-08-1994**

Firma:

Nombre: **C.S. Lau**
Cargo: **Quality Assurance Manager**

(N) Norge

Typeskilt finnes på apparatens underside.

Observer: Nettbryteren er sekundert innkoplet. Den
innebygde nettdelen er derfor ikke frakoplet nettet så
lenge apparatet er tilsluttet nettkontakten.

(MEX) México

NOM



Lea cuidadosamente su instructivo de manejo
Garantía página 56

(BR) Brasil

Garantía página 56

(AUS) Australia

Guarantee page 57

(NZ) New Zealand

Guarantee page 57

IMPORTANT NOTES FOR USERS IN THE U.K.

Mains plug

This apparatus is fitted with an approved moulded 13 Amp plug. To change a fuse in this type of plug proceed as follows:

- Remove fuse cover and fuse.
- Fix new fuse which should be a BS1362 5 Amp, A.S.T.A. or BSI approved type.
- Refit the fuse cover

If the fitted plug is not suitable for your socket outlets, it should be cut off and an appropriate plug fitted in its place.

If the mains plug contains a fuse, this should have a value of 5 Amp. If a plug without a fuse is used, the fuse at the distribution board should not be greater than 5 Amp

Note: The severed plug must be disposed to avoid a possible shock hazard should it be inserted into a 13 Amp socket elsewhere

How to connect a plug

The wires in the mains lead are coloured with the following code: blue = neutral (N), brown = live (L). As these colours may not correspond with the colour markings identifying the terminals in your plug, proceed as follows:

- Connect the blue wire to the terminal marked N or coloured black.
- Connect the brown wire to the terminal marked L or coloured red
- Do not connect either wire to the earth terminal in the plug, marked E (or \oplus) or coloured green (or green and yellow).

Before replacing the plug cover, make certain that the cord grip is clamped over the sheath of the lead - not simply over the two wires.

Copyright in the U.K.: Recording and playback of material may require consent. See Copyright Act 1956 and The Performer's Protection Acts 1958 to 1972.

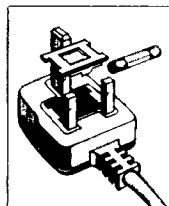

AE2340/00 CPU BOARD

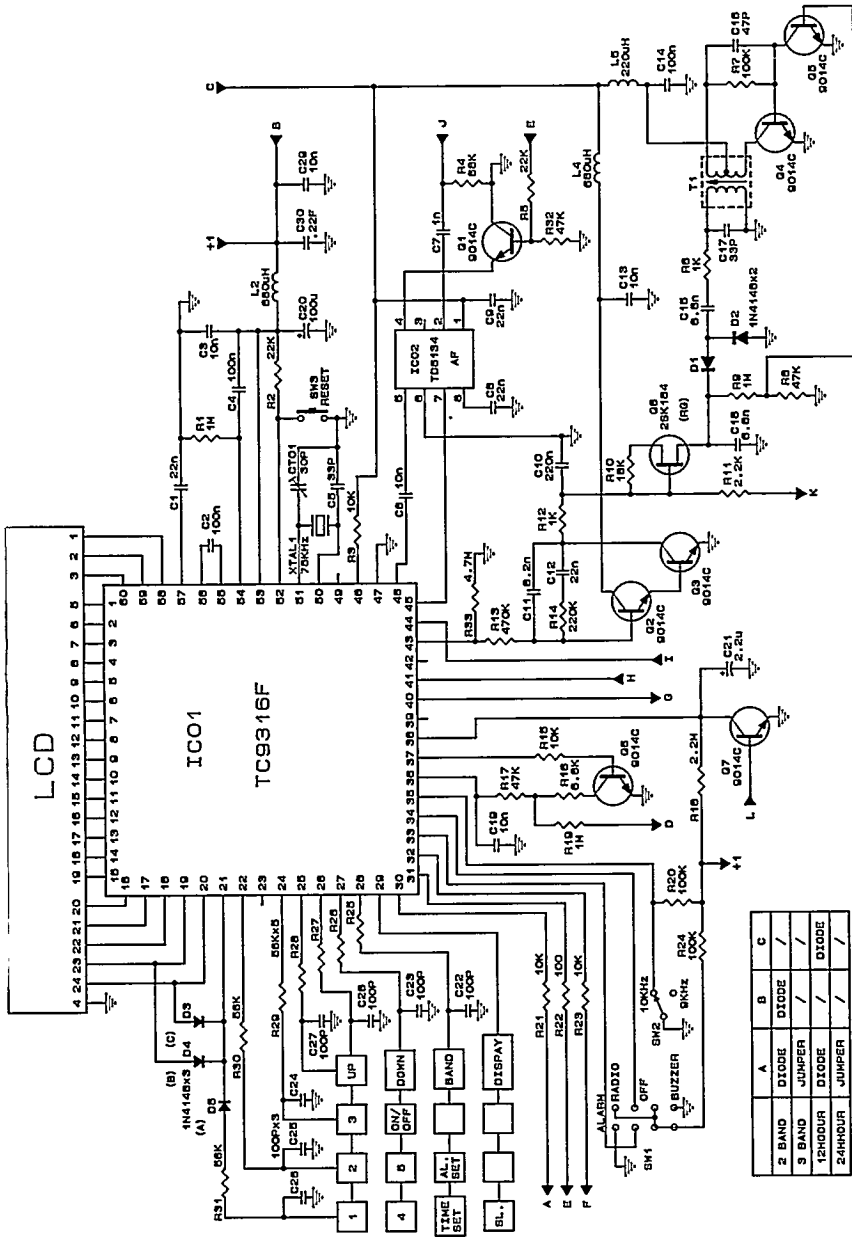

AE2340/00 AUDIO BOARD

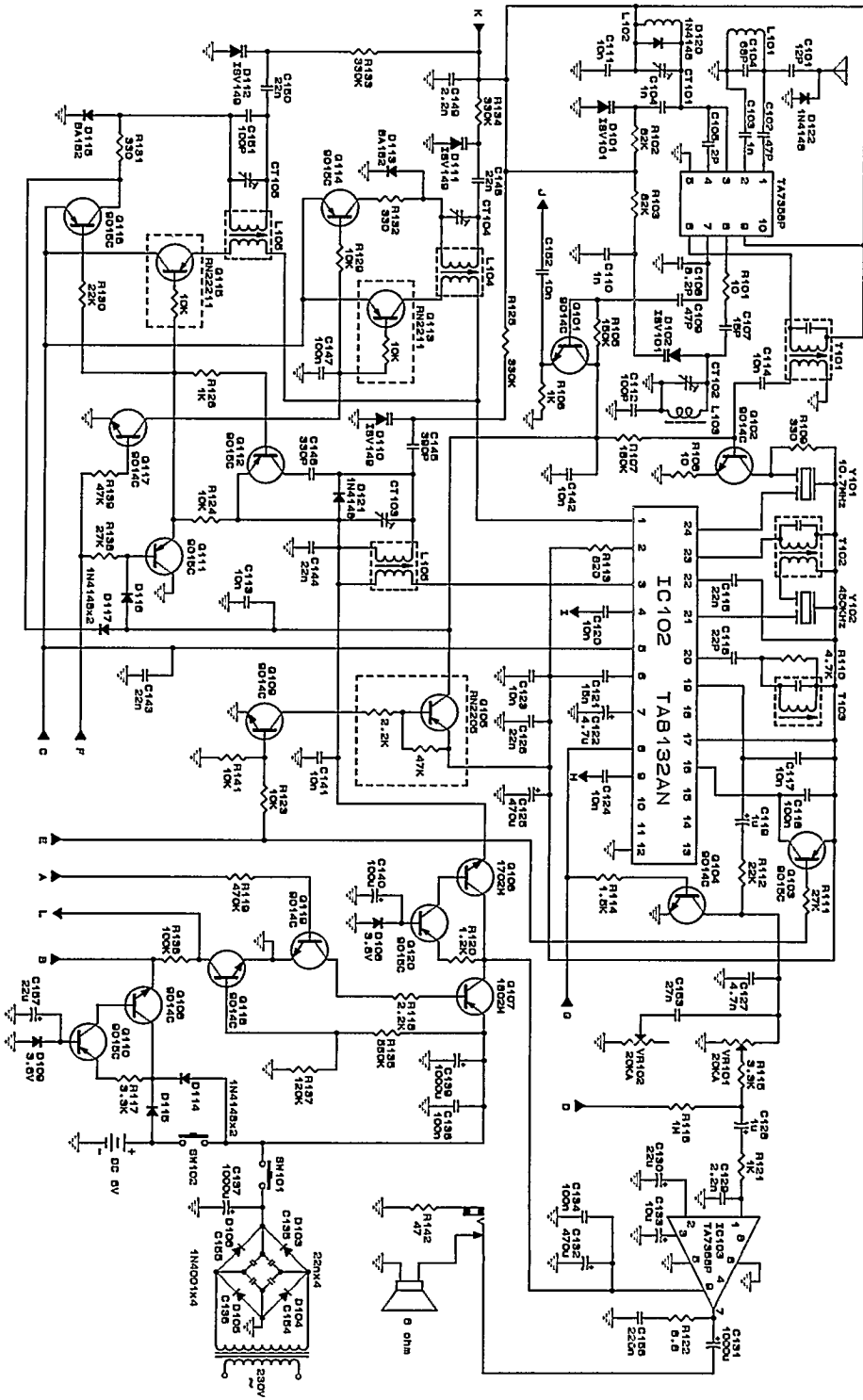

Controls

CONTROLS

- ① **POWER** - for switching the radio on and off
- ② **Telescopic aerial**
- ③ **BAND** - for selecting the wave band
- ④ **PRESET 1...5** - for selecting and storing preferred stations (5 per wave range)
- ⑤ **TUNING/TIME ADJUST** - for tuning to a radio station and adjusting the time
- ⑥ **VOLUME** - for adjusting the volume
- ⑦ **STONE** - for adjusting the tone
- ⑧ **ALARM** - for switching the alarm on and off
- ⑨ **PHONE** - for connecting headphones
- ⑩ **Voltage selector** (*not all versions*) - for selecting the voltage
- ⑪ **AC MAINS** - for connecting the mains lead
- ⑫ **SET ALARM** - for setting the alarm time
- ⑬ **DISPLAY** - To display either frequency, time or alarm time
- ⑭ **SET TIME** - for setting the time
- ⑮ **SET ALARM** - for setting the alarm time
- ⑯ **9/10 kHz** switch, having a double function:
AM tuning step.....FM tuning step
 - 9 kHz50 kHz
 - 10 kHz100 kHz
- ⑰ **RESET** - for erasing the memory

WARNINGS

- Rain, damp and excessive heat are bad for the radio and the batteries.
- Do not leave the set for any length of time in direct sunlight or other places where high temperatures can occur, such as in a car which is parked in the sun.
- Leave repairs to a recognized dealer or service organisation.
- If you repair the set yourself, the guarantee will be invalidated.

This unit complies with the radio interference requirements as laid down in EC (European Community) regulations.

The type plate is located on the base of the set.

Display

DISPLAY

The display provides information about the functioning of your radio.
When you switch off the radio, the current time will be indicated.



- Press DISPLAY to display the alarm time.
- Press DISPLAY again to display the time. The display also returns to time indication automatically after 5 seconds.
- When tuning the radio, the tuned frequency and the selected wave range will appear.
- Press DISPLAY to display the time.
- Press DISPLAY again to display the alarm time.
- Press DISPLAY once more to display the frequency again. The display also returns to frequency indication automatically after 5 seconds.

Power supply

MAINS SUPPLY

- Check if the mains voltage as shown on the type plate (*at the base of the set*) corresponds to your local mains supply. If it does not, consult your dealer or service organisation. *If the set is equipped with a VOLTAGE SELECTOR ⑩ (at the rear of the set), set this selector to the local mains voltage.*
- Connect the mains lead to the AC MAINS socket ⑪ (*at the rear of the set*) and the wall socket.
The mains supply is now switched on.
- To disconnect the set from the mains completely, withdraw the mains plug from the wall socket.

BATTERIES

- Open the battery compartment and insert 4 batteries type R20, UM1 or D-cells.
- Remove the batteries:
 - when they are exhausted;
 - if they are not going to be used for a long period of time;
 - when the battery indicator  starts flashing.

Note:

When the set is connected to the mains, the battery supply is switched off automatically.

Warning for weak batteries

When the batteries run low, the radio will show the time display. Pressing POWER ① or SLEEP ⑫ will turn on the radio for a short period of time before it automatically turns off again. The period will get shorter as the batteries run lower.

Continued operation with low batteries causes malfunctioning and losing programmed time settings and preset radio stations. In this case, remove the batteries, press the RESET button ⑰ in the battery compartment briefly and insert fresh batteries.

Readjust the timer setting and the preset radio stations.

POWER FAILURE

- If the power supply is interrupted, the battery indicator  starts flashing.
- The programmed time settings and preset radio stations will be kept in the memory for 2 min.
- If the AC power is interrupted, the batteries (if present) will take over the supply. In this case all settings will be kept in the memory.

Radio reception

9/10 kHz SELECTOR

The minimum 'frequency distance' (span division) between adjacent radio stations (measured in kHz) is standardized all over the world. However, North and South America use another standard than the rest of the world. This means that the radio should use a tuning step according to the standard concerned in order to obtain accurate radio tuning. The 9/10 kHz switch ⑯ in the battery compartment allows accurate tuning for both standards and has a double function.

Position 10 kHz for the Americas

- AM tuning step 10 kHz;
- FM tuning step 100 kHz;

Position 9 kHz for the the rest of the world

- AM tuning step 9 kHz;
- FM tuning step 50 kHz;

AERIALS

- For FM reception extend the telescopic aerial fully.
To improve the reception you can incline and rotate the aerial. If the FM signal received is too strong (in the direct vicinity of the transmitter) you can retract the aerial.
- For the medium wave (AM/MW), and long wave (LW) the set has a built-in aerial, so the telescopic aerial is not needed. You can direct the aerial by turning the set itself.

RADIO RECEPTION

- Press POWER ① to switch the radio on.
- Adjust the sound with VOLUME ⑥ and TONE ⑦.
- You can connect headphones to the PHONE socket ⑨.
The loudspeaker will then be switched off.
- Set the wave range with the BAND switch ③ (*LW not on all versions*).
- The selected wave range will appear on the display.
- Tune to a radio station either manually, automatically or with the PRESET buttons ④ (see 'TUNING' and 'PRESET RADIO STATIONS').
- Press POWER ① once again to switch the radio off. The display will now indicate the current time.

Tuning

TUNING TO A STATION

There are two possibilities for tuning to a station:

- **Automatically** - the stations are sought automatically.
- **Manually** - This is easy if the frequency of the station is already known (e.g. from your radio and television guide).

Automatic tuning

- Select the wave band using the BAND selector.
- Keep ⏏ or ⏏ pressed until the frequency on the display starts running. Then release the button and the tuner will search until a station of sufficient strength has been found. Weak radio stations are skipped during search tuning.
- If the radio station found is not the desired one, repeat this step.

Manual tuning

Weak radio stations are skipped during search tuning. If you know the frequency of the desired radio station, you can tune to it as follows:

- Keep ⏏ or ⏏ pressed; the frequency on the display starts running.
- If you approach the required frequency, stop running by pressing the opposite TUNING button (⏏ or ⏏).
- Now press ⏏ or ⏏ briefly each time to change the frequency step-by-step until the required frequency has been reached or optimum reception is obtained.

Preset stations

PRESET RADIO STATIONS

You can programme 15 stations into the memory, 5 on each waveband.

- Select the wave range with the BAND switch ③.
- Tune to a radio station automatically or manually.
- Keep the desired PRESET button ④ pressed until you hear a double bleep.
- The station has now been programmed and the PRESET number will appear on the display.
- Repeat these steps for the other stations you wish to programme.

Calling up preset stations

- Select the wave range with BAND switch ③.
- Press one of the PRESET 1...5 buttons ④. The frequency and the PRESET number will appear on the display.

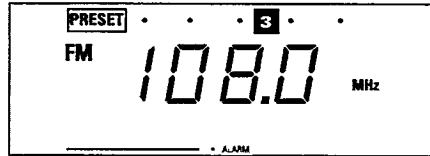

ERASING THE MEMORY

- You can erase the memory by pressing RESET ⑰ (in the battery compartment).
- All settings must now be reprogrammed into the memory.

SETTING THE TIME

The time can be set either with the power on or off.

- Press SET TIME (14).
- The time on the display starts flashing.
- Now you can set the time using Δ or ∇ (5).

ALARM FUNCTION

You can use your radio as an alarm clock. To use this function you first have to set the alarm time.

You can choose to be woken up by buzzer or by radio.

The alarm time can be set either with the power on or off.

Setting the alarm time

- Press SET ALARM (15).
- The alarm time will appear and the alarm indication will start flashing on the display:

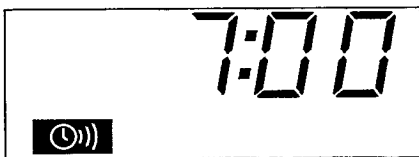

- Now you can set the alarm time using Δ or ∇ (5).

Switching the alarm on

- Set ALARM (8) to:
 - RADIO if you wish to be woken by the radio;
 - BUZZ if you wish to be woken by the buzzer.
- At the set alarm time you will be woken by the radio or the buzzer.
- The buzzer will become louder after 10 seconds.

Switching the alarm off completely

- Set ALARM (8) to OFF.

Switching the alarm off for 24 hours

- Press any button on the set to switch the alarm off.
- The alarm switches itself off automatically after one hour.

SLEEP FUNCTION

Your radio is equipped with a sleep function. It enables you to continue listening to the radio while you fall asleep. After 90, 60, 30 or 10 minutes the radio will be switched off automatically.

Switching the sleep function on

- Press SLEEP (12).
- The radio will come on and the SLEEP indication and the length of time before the radio will switch off will appear on the display.

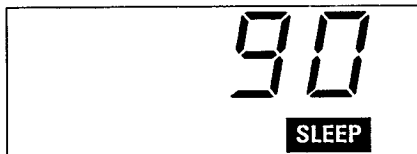

- Now select the desired length of time within 5 seconds by pressing SLEEP (12) briefly. Each time you press SLEEP the length of time will change step by step; 90, 60, 30 or 10 minutes.
- The frequency and the SLEEP indication will then appear on the display.

Switching the sleep function off

The sleep function can be switched off before the set time has elapsed:





- Press SLEEP (12) or POWER (1). The SLEEP indication will disappear from the display and the radio will switch off.

Troubleshooting

If a fault occurs, first check the points listed below before taking the system for repair. If you are unable to remedy a problem by following these hints, consult your dealer or service centre.

WARNING

Under no circumstances should you try to repair the system units yourself, as this would invalidate the guarantee.

PROBLEM	POSSIBLE CAUSE	REMEDY
No sound	<ul style="list-style-type: none"> - Batteries are exhausted - Batteries are incorrectly inserted - Mains lead is not properly connected - The VOLUME is not adjusted - Headphones are connected 	<ul style="list-style-type: none"> • Insert fresh batteries • Insert the batteries correctly • Connect the mains lead properly • Adjust the VOLUME • Disconnect the headphones
Radio interrupt	<ul style="list-style-type: none"> - Preset sleeptime due - Batteries are nearly exhausted 	<ul style="list-style-type: none"> • Insert fresh batteries or use the mains supply
Poor radio reception	<ul style="list-style-type: none"> - Weak radio aerial signal - Interference caused by the vicinity of electrical equipment like TVs, video recorders, computers, thermostats, fluorescent lamps (TL), engines etc. - Inaccurate tuning because of incorrect 9/10 kHz selector  setting 	<ul style="list-style-type: none"> • Aim the aerial for best reception: <ul style="list-style-type: none"> - FM: incline and rotate telescopic aerial - AM (MW/LW): rotate the whole set • Keep the radio away from electrical equipment • Adjust the 9/10 kHz selector  (in the battery compartment 10 kHz for the Americas 9 kHz for other countries).
Alarm does not function	<ul style="list-style-type: none"> - Alarm time is not adjusted - Headphones are connected 	<ul style="list-style-type: none"> • Adjust the alarm time • Disconnect the headphones
Set does not react to operation of any button	<ul style="list-style-type: none"> - Electrostatic discharge 	<ul style="list-style-type: none"> • Press the RESET button  briefly (in the battery compartment) and readjust the time settings and preset radio stations
Malfunctioning and losing time settings and preset radio stations	<ul style="list-style-type: none"> - Continued operation with weak batteries 	<ol style="list-style-type: none"> 1 Remove the batteries. 2 Press the RESET button  briefly in the battery compartment. 3 Insert fresh batteries. 4 Readjust the time settings and the preset radio stations.

**Garantía para México**

Este aparato está fabricado con materiales de alta calidad y ha sido cuidadosamente verificado. Philips, por lo tanto, da a usted una garantía de 12 meses a partir de su fecha de compra.

La garantía ampara la reposición de las piezas defectuosas debidas a fallas en su montaje o en los materiales, incluyendo la mano de obra necesaria para su reemplazo en nuestras Sucursales o talleres autorizados.

En caso de fallas en su aparato le rogamos se sirva poner en contacto con su distribuidor.

Esta garantía no cubrirá las averías que resulten como consecuencia de una instalación incorrecta del aparato, manifiesto maltrato o uso inadecuado del mismo.

Philips se obliga a reparar y devolver a usted su aparato en un plazo no mayor de 30 días hábiles contados a partir de la fecha de haber ingresado su aparato a uno de nuestros talleres.

Con la presentación de la factura o remisión de su aparato podrá hacer efectiva la garantía.

Si usted tiene alguna duda o pregunta que no le pueda solucionar su distribuidor, por favor ponerse en contacto con:

**Oficinas Centrales de Servicio,
Av. Coyoacán No. 1051,
Col. del Valle,
03100 México, D.F.
☎ 5-75-20-22 o 5-75-01-00**

Garantía para Brasil

Este aparelho é garantido pela Philips do Brasil Ltda. e a Philips da Amazônia S.A. Indústria Eletrônica, por um período superior ao estabelecido por lei. Porém, para que a garantia tenha validade, é imprescindível que, além deste certificado, seja apresentada a nota fiscal de compra do produto.

1. Philips do Brasil Ltda. e Philips da Amazônia S.A. Indústria Eletrônica asseguram ao proprietário consumidor deste aparelho a garantia de 180 dias (90 dias legal mais 90 dias adicional) contados a partir da data de entrega do produto, conforme expresso na nota fiscal de compra que passa a fazer parte deste certificado.
2. Esta garantia perderá sua validade se.
 - A. O defeito apresentado for ocasionado por uso indevido ou em desacordo com o seu manual de instruções.
 - B. O produto for alterado, violado, ajustado ou consertado por pessoa não autorizada pela Philips.
 - C. O produto for ligado a fonte de energia (rede elétrica, pilhas, bateria, etc.) de características diferentes das recomendadas no manual de instruções e/ou no produto
 - D. O número de série que identifica o produto estiver de alguma forma adulterado ou rasurado.
3. Estão excluídos desta garantia defeitos decorrentes do descumprimento do manual de instruções do produto, de casos fortuitos ou de força maior, bem como aqueles causados por agentes da natureza e acidentes.
4. Excluem-se igualmente desta garantia os defeitos decorrentes do uso dos produtos em serviços não doméstico/residencial regular ou em desacordo com o uso recomendado.
5. Nos municípios onde não exista oficina autorizada de serviço Philips, as despesas de transporte do aparelho e/ou do técnico autorizado correm por conta do sr. consumidor requerente do serviço.

**Philips do Brasil Ltda. e
Philips da Amazônia S.A. Indústria Eletrônica**

Para informações adicionais sobre o produto ou para eventual necessidade de utilização da rede de oficinas autorizadas, ligue para o centro de informação ao consumidor:

☎ **0800-123123** (discagem direta gratuita)
ou escreva para a caixa postal:
21462 cep 04693-970 - São Paulo