

Register your product and get support at
www.philips.com/TVsupport

6604 series

User Manual

50PUT6604
58PUT6604

PHILIPS

Contents

1 Get Support	3
1.1 Identify and Register your TV	3
1.2 TV Help and User Manual	3
1.3 On-line Help and User Manual	3
1.4 Consumer Care / Repair	3
2 Software	5
2.1 Update Software	5
2.2 Software Version	5
3 Quick Guide	6
3.1 Remote Control	6
3.2 IR sensor	7
3.3 Joystick - Local Control	7
4 Setting Up	8
4.1 Read Safety	8
4.2 TV Placement	8
4.3 Turn on TV	8
5 Connections	10
5.1 Connectivity guide	10
5.2 Antenna	10
5.3 Video Device	10
5.4 Audio Device	10
5.5 Mobile Device	11
5.6 Other Device	12
6 Switch Source	14
6.1 Source List	14
6.2 Rename Device	14
7 Channels	15
7.1 About Channels and Switch Channels	15
7.2 Install Channel	15
7.3 Channel List	18
7.4 Favourite Channels	19
7.5 Text / Teletext	20
8 TV Guide	22
8.1 What You Need	22
8.2 Using the TV Guide	22
9 Recording and Pause TV	24
9.1 Recording	24
9.2 Pause TV	25
10 Videos, Photos and Music	26
10.1 From a USB Connection	26
10.2 Photos	26
10.3 360 Photo	26
10.4 Videos	27
10.5 Music	27
11 Open TV Setting Menus	28
11.1 Home Menu Overview	28
11.2 Frequent settings and All settings	28
11.3 All Settings	28
12 Wireless and Networks	38
12.1 Home Network	38
12.2 Connect to Network	38
12.3 Wireless and Network Settings	39
13 Smart TV	41
13.1 Setup Smart TV	41
13.2 Smart TV Start Page	41
13.3 App Gallery	41
14 Video on Demand	42
15 Netflix	43
16 Amazon Prime Video	44
17 YouTube	45
18 Environmental	46
18.1 End of Use	46
19 Specifications	47
19.1 Power	47
19.2 Reception	47
19.3 Display Resolution	47
19.4 Supported Input Resolution - Video	47
19.5 Supported Input Resolution - Computer	47
19.6 Sound	47
19.7 Multimedia	48
19.8 Connectivity	48
20 Troubleshooting	49
20.1 Tips	49
20.2 Switch On	49
20.3 Remote Control	49
20.4 Channels	49
20.5 Picture	50
20.6 Sound	51
20.7 HDMI - UHD	51
20.8 USB	51
20.9 Wi-Fi and Internet	51
20.10 Wrong Menu Language	52
21 Safety and Care	53
21.1 Safety	53
21.2 Screen Care	54
22 Terms of Use	55
23 Copyrights	56
23.1 HDMI	56
23.2 Dolby Audio	56
23.3 Dolby Vision and Dolby Atmos	56
23.4 DTS-HD (italics)	56
23.5 Wi-Fi Alliance	56
23.6 Other Trademarks	56
24 Open Source	57
24.1 Open Source Software	57
24.2 Open Source License	57
25 Disclaimer regarding services and/or software offered by third parties	61
Index	62

Get Support

1.1

Identify and Register your TV

Identify your TV - TV model number and serial number

You might be asked to provide the TV product model number and serial number. Find these numbers on the packaging label or on the type label on the back or bottom of the TV.

Register your TV

Register your TV and enjoy a range of benefits including full support (including downloads), privileged access to information about new products, exclusive offers and discounts, the chance to win prizes and even participate in special surveys about new releases.

Go to www.philips.com/TVsupport

1.2

TV Help and User Manual

↑ (Home) > Settings > Help

You can use Help function to diagnose and get more information about your TV.

- **How to** - You can see instructions on how to install channels, sort channels, update TV software, connect external devices and use Smart functions on your TV.

- **Check the TV** - You can check if the picture, sound, Ambilight* are working fine during playing a short video clip.

- **Check the network** - Check the network connection.

- **View weak signal history** - Display the list of channel numbers that were automatically saved when signal strength was weak.

- **Update software** - Check available software updates.

- **User manual** - Read the user manual for TV information.

- **Troubleshooting** - Find a solution for frequent ask questions.

- **Factory settings** - Reset all settings to factory settings.

- **Reinstall TV** - Reinstall and redo the complete TV installation.

- **Contact info** - Show the telephone number or web address for your country or region.

* Ambilight setting is only for models which support

Ambilight function.

1.3

On-line Help and User Manual

To solve any Philips TV related problem, you can consult our online support. You can select your language and enter your product model number.

Go to www.philips.com/TVsupport.

On the support site you can find your country's telephone number to contact us as well as answers to frequently asked questions (FAQs). In some countries, you can chat with one of our collaborators and ask your question directly or send a question by email. You can download new TV software or the manual to read on your computer.

For more TV troubleshooting and frequently asked questions (FAQs)...

Go

to <http://philips-tvconsumercare.kxondemand.com/portal/en/ModelSelect>

TV Help on your tablet, smartphone or computer

To carry out extended sequences of instructions more easily, you can download the TV Help in PDF format to read on your smartphone, tablet or computer. Alternatively, you can print the relevant Help page from your computer.

To download the Help (user manual) go to www.philips.com/TVsupport

1.4

Consumer Care / Repair

For support and repair, call the Consumer Care hotline in your country. Our service engineers will take care of a repair, if necessary.

Find the telephone number in the printed documentation that came with the TV.

Or consult our website www.philips.com/TVsupport and select your country if needed.

TV model number and serial number

You might be asked to provide the TV product model number and serial number. Find these numbers on the packaging label or on the type label on the back or bottom of the TV.

⚠ Warning

Do not attempt to repair the TV yourself. This may

cause severe injury, irreparable damage to your TV or void your warranty.

Software

Update Software

Search for Updates

Update from Internet

🏠 (Home) > Settings > Update software > Search for updates > Internet (Recommended)

Look for a software update yourself.

- If the TV is connected to the Internet, you may receive a message to update the TV software. You need a high-speed (broadband) Internet connection. If you receive this message, we recommend you to carry out the update.
- During the software update, there is no picture and the TV will switch off and on again. This might happen several times. The update can take a few minutes.
- Wait until the TV picture comes back up. Do not press the power switch  on the TV or on the remote control during the software update.

Update from USB

🏠 (Home) > Settings > Update software > Search for updates > USB

- You need a computer with an high-speed Internet connection and a USB memory device to upload the software on the TV.

· Use a USB memory device with 512MB free space. Make sure that write protection is switched off.

1 - Start the update on TV

Select **Update software** > **Search for updates** > **USB**, then press **OK**.

2 - Identify the TV

Insert the USB memory into one of the USB connections of the TV.

Select **Start** and press **OK**. An identification file is written on the USB memory device.

3 - Download the TV software

- Insert the USB memory into your computer.

- On the USB memory device, locate the file **update.html** and double click it.

- Click on **Send ID**.

- If new software is available, download the .zip file.

- After the download, unzip the file and copy the file **autorun.upg** onto the USB memory device.

- Do not place this file in a folder.

4 - Update the TV software

Insert the USB memory into the TV again. The update starts automatically.

The TV switches itself off for 10 seconds and then

back on again. Please wait.

Do not . . .

- use the remote control
- remove the USB memory device from the TV
- press  twice
- press the power switch on the TV

The TV switches itself off (for 10 seconds) and then back on again. Please wait.

The TV software has been updated. You can use the TV again.

To prevent an accidental update of the TV software, delete the autorun.upg file from the USB memory device.

Local Updates

🏠 (Home) > Settings > Update software > Search for updates > USB > Local updates.

For dealers and expert users.

Look for OAD updates (Over-the-air Download)

🏠 (Home) > Settings > Update software > Search for updates > Look for OAD updates.

Scan to search for an Over-the-air software update.

Software Version

🏠 (Home) > Settings > Update software > Current software info

To view the current TV software version.

Quick Guide

3.1

Remote Control

Batteries and Cleaning

Replace batteries

If the TV does not react on a key press on the remote control, the batteries might be empty.

To replace the batteries, open the battery compartment on the back of the remote control.

- 1 - Slide the battery door in the direction shown by the arrow.
- 2 - Replace the old batteries with 2 type **AAA-R03-1.5V** batteries. Make sure the + and the - ends of the batteries line up correctly.

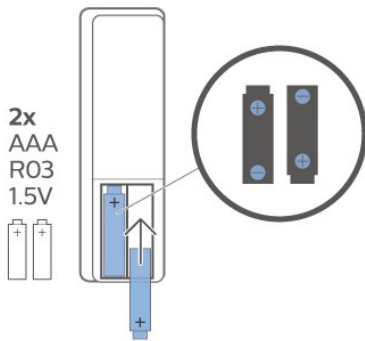

- 3 - Reposition the battery door and slide it back until it clicks.

- Remove the batteries if you are not using the remote control for a long time.
- Safely dispose of your old batteries according to the end of use directions.

Cleaning

Your remote control is treated with a scratch-resistant coating.

To clean the remote control, use a soft damp cloth. Never use substances such as alcohol, chemicals or household cleaners on the remote control.

Key Overview

Top

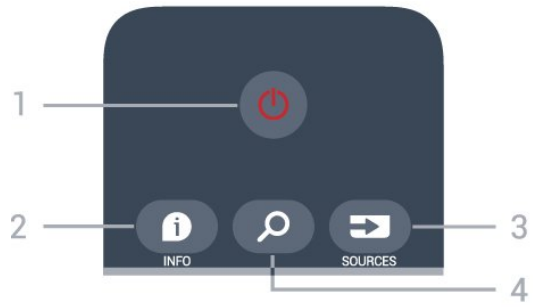

- 1 - **Standby / On**
To switch the TV on or back to Standby.
- 2 - **INFO**
To open or close programme info.
- 3 - **SOURCES**
To open the Sources menu.
- 4 - **Search**
To open the Smart TV searches page.

Middle

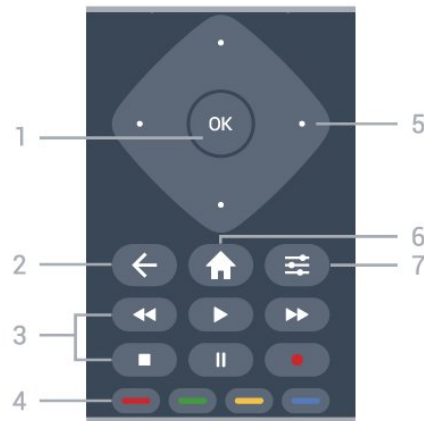

- 1 - **OK key**
To confirm a selection or setting. To open the channel list while watching TV.
- 2 - **BACK**
To close a menu without changing a setting.
- 3 - **Playback and Record**
 - Play ►, to playback.
 - Pause ||, to pause playback
 - Stop ■, to stop playback
 - Rewind ◀◀, to rewind
 - Fast forward ▶▶, to go fast forward
 - Record ●, to start recording
- 4 - **Colour keys**
Direct selection of options. Blue key **■**, opens **Help**.
- 5 - **Arrow / navigation keys**
To navigate up, down, left or right.
- 6 - **Home**
To open the Home menu.

7 - OPTIONS

To open or close the Options menu.

Bottom

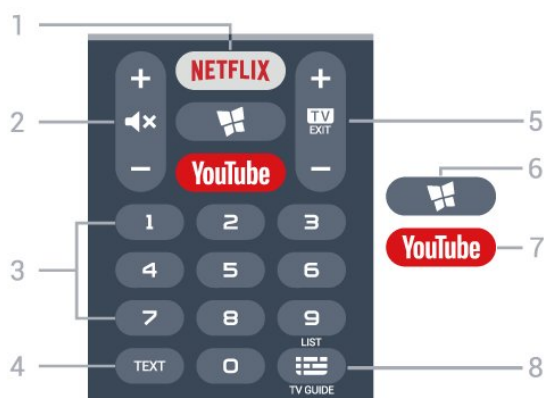

1 - **NETFLIX**

To open the Netflix App directly. With the TV switched on or from standby.

· If you have a Netflix membership subscription, you can enjoy Netflix on this TV. Your TV must be connected to the Internet.

· To open Netflix, press **NETFLIX** to open the Netflix App. You can open Netflix immediately from a TV in standby.

www.netflix.com

2 - Mute / Volume

Press in middle to mute the sound or to restore it. Prese + or - to adjust the volume level.

3 - Number keys

To select a channel directly.

4 - **TEXT**

To open or close Text/Teletext.

5 - - EXIT

Press in middle to switch back to watch TV. To stop an interactive TV application. Prese + or - to switch to the next or previous channel in the channel list. To open the next or previous page in Text/Teletext.

6 - **SMART TV**

To open the Smart TV start page.

7 - **YouTube**

To open the YouTube App directly.

8 - **TV Guide / Channel list**

To open or close the TV Guide. Long press to open the channel list.

3.2

IR sensor

The TV can receive commands from a remote control that uses IR (infrared) to send commands. If you use such a remote control, always make sure you point the remote control at the infrared sensor on the front of the TV.



Warning

Do not put any objects in front of IR sensor of the TV, it may block the IR signal.

3.3

Joystick - Local Control





Keys on TV

If you lost the remote control or its batteries are empty, you can still do some basic TV operations.

To open the basic menu...



1 - With the TV switched on, press the joystick key on the back of the TV to bring up the basic menu.

2 - Press left or right to select  Volume,  Channel or  Sources. Select  Demo, to start a demo movie.

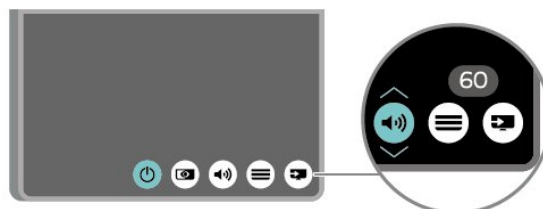

3 - Press up or down to adjust the volume or tune to the next or previous channel. Press up or down to go through the list of sources, including the tuner selection.

The menu will disappear automatically.

Setting Up

4.1

Read Safety

Read the safety instructions first before you use the TV.

To read the instructions, in **Help > User manual**, press the colour key **— Keywords** and look up **Safety and Care**.

4.2

TV Placement

Tips on Placement

- Position the TV where light does not shine directly on the screen.
- Position the TV up to 15 cm away from the wall.
- The ideal distance to watch Ultra HD TV is 2 to 5 times of its screen height. When seated, your eyes should be level with the centre of the screen.

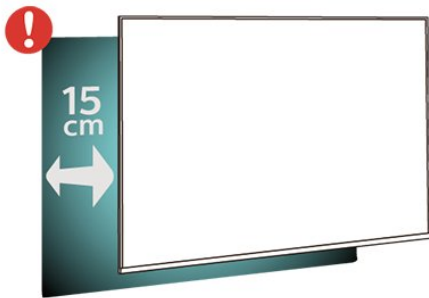

Note:

Please keep the TV away from dust-producing sources such as stoves. It is suggested to clean the dust regularly to avoid getting dust into the TV.

TV Stand

You can find the instructions for mounting the TV stand in the Quick Start Guide that came with the TV. In case you lost this guide, you can download it from www.philips.com/TVsupport.

Use the model number of the TV to look for the **Quick Start Guide** to download.

Wall Mounting

Your TV is also prepared for a VESA-compliant wall mount bracket (sold separately).

Use the following VESA code when purchasing the wall mount . . .

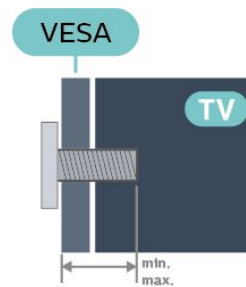

- 50PUT6604
VESA MIS-F 200x200, M6 (Minimum 20 mm, Maximum 30 mm)
- 58PUT6604
VESA MIS-F 300x200, M6 (Minimum 20 mm, Maximum 24 mm)

Preparation

Make sure that the metal screws, to mount the TV to the VESA-compliant bracket, go about 10mm deep inside the threaded bushes of the TV.

Caution

Wall mounting the TV requires special skills and should only be performed by qualified personnel. The TV wall mounting should meet safety standards according to the TV's weight. Also read the safety precautions before positioning the TV. TP Vision Europe B.V. bears no responsibility for improper mounting or any mounting that results in accident or injury.

4.3

Turn on TV

Connect Power Cable

- Insert the power cable into the **POWER** connector on the back of the TV.
- Make sure the power cable is securely inserted in the connector.
- Make sure that the power plug, in the wall socket, is accessible at all times.
- When you unplug the power cable, always pull the plug, never pull the cable.

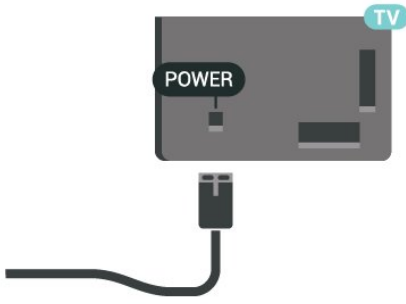

Although this TV has a very low standby power consumption, unplug the power cable to save energy if you do not use the TV for a long period of time.

On or Standby

Before you switch on the TV, make sure you plugged in the mains power in the **POWER** connector on the back of the TV.

Switch On

- Press the small joystick key on the back of the TV.



Switch to standby

To switch the TV to standby, press  on the remote control. You can also press the small joystick key on the back of the TV.

In standby mode, the TV is still connected to the mains power but consumes very little energy.

To switch off the TV completely, disconnect the power plug.

When disconnecting the power plug, always pull the power plug, never the cord. Ensure that you have full access to the power plug, power cord and outlet socket at all times.

Connections

5.1

Connectivity guide

Always connect a device to the TV with the highest quality connection available. Also, use good quality cables to ensure a good transfer of picture and sound.

When you connect a device, the TV recognizes its type and gives each device a correct type name. You can change the type name if you wish. If a correct type name for a device is set, the TV automatically switches to the ideal TV settings when you switch to this device in the Sources menu.

5.2

Antenna

Insert the antenna plug firmly into the Antenna socket at the back of the TV.

You can connect your own antenna or an antenna signal from an antenna distribution system. Use an IEC Coax 75 Ohm RF antenna connector.

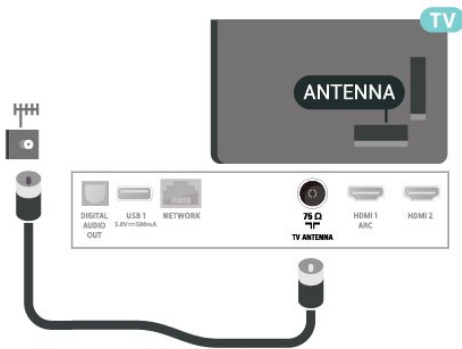

5.3

Video Device

HDMI

An HDMI connection has the best picture and sound quality.

For best signal quality transfer, use a High speed HDMI cable and do not use an HDMI cable longer than 5 m, and also connect devices supporting HDR on any one of HDMI connections.

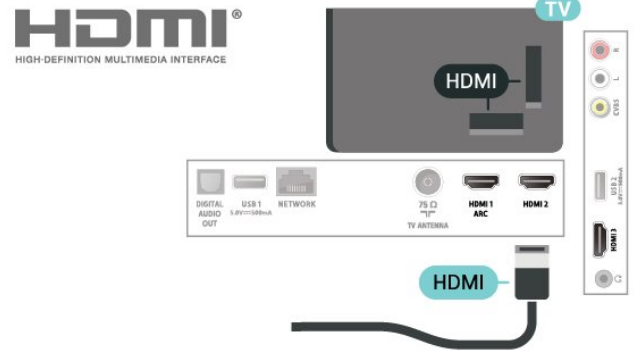

Copy protection

HDMI ports support HDCP (High-bandwidth Digital Content Protection). HDCP is a copy protection signal that prevents copying content from a DVD disc or Blu-ray Disc. Also referred to as DRM (Digital Rights Management).

Composite

CVBS - Composite Video is a standard quality connection. Next to the CVBS signal adds the Audio Left and Right signals for sound.

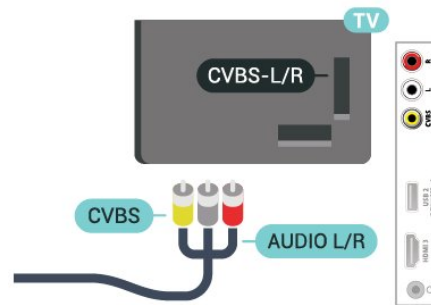

5.4

Audio Device

HDMI ARC

Only HDMI 1 on the TV have HDMI ARC (Audio Return Channel).

If the device, typically a Home Theatre System (HTS), also has the HDMI ARC connection, connect it to HDMI 1 connection on this TV. With the HDMI ARC connection, you do not need to connect the extra audio cable that sends the sound of the TV picture to the HTS. The HDMI ARC connection combines both signals.

Mobile Device

Wi-Fi Direct / Miracast

About Wi-Fi Miracast

You can view your photos or play your music and videos from a mobile device on your TV with Wi-Fi Miracast™. The mobile device and the TV should be within range, which usually means being in the same room.

Check if your mobile device is ready for Miracast.

Your TV is a **Wi-Fi CERTIFIED Miracast™** device. With Miracast™, you can watch and share the screen of your smartphone, tablet or computer on your TV screen wirelessly. You can stream videos (audio and video), share photos or anything else that's on screen of the device. No need to connect the device to your home network. Both the TV and the device must be Wi-Fi CERTIFIED Miracast™ devices and have Miracast switched on.

Miracast on this TV is subject to the HDCP protocol and cannot display copy-protected premium content sent by a device. The maximum video resolution supported is 720p for 2.4GHz Wi-Fi or 1080p for 5GHz Wi-Fi.

For more information on Wi-Fi CERTIFIED Miracast™ go to www.wi-fi.org

Wi-Fi®, the Wi-Fi CERTIFIED logo, the Wi-Fi logo are registered trademarks of the Wi-Fi Alliance. **Wi-Fi CERTIFIED Miracast™**, **Miracast™** are trademarks of the Wi-Fi Alliance.

Using Miracast

Switch on Miracast

Press **➔ SOURCES > Miracast**

Share a Screen on TV

- 1 - Activate Miracast (Screen mirroring) on your mobile device.
- 2 - On your mobile device, select the TV. (This TV will be displayed as TV model name)
- 3 - Select the TV name on your mobile device, after connection, you can enjoy using Miracast.

Stop Sharing

You can stop sharing a screen from the TV or from the mobile device.

From the device

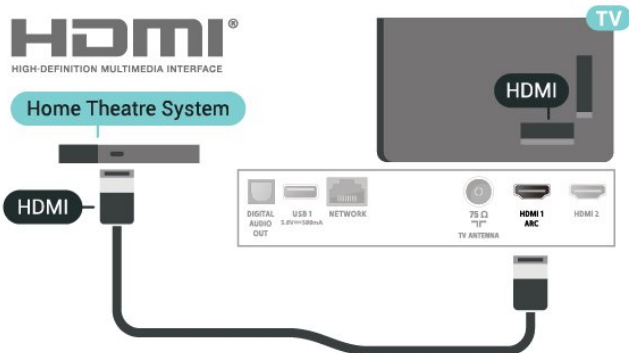

Digital Audio Out - Optical

Audio Out - Optical is a high quality sound connection.

This optical connection can carry 5.1 audio channels. If your device, typically a Home Theatre System (HTS), has no HDMI ARC connection, you can use this connection with the Audio In - Optical connection on the HTS. The Audio Out - Optical connection sends the sound from the TV to the HTS.

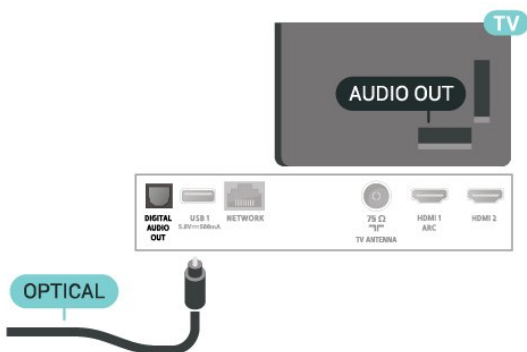

Headphones

You can connect a set of headphones to the  connection on the side of the TV. The connection is a mini-jack 3.5mm. You can adjust the volume of the headphones separately.

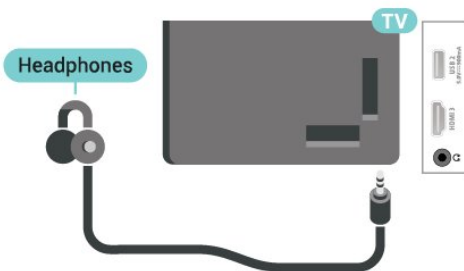

With the application you use to start Miracast, you can disconnect and stop watching the screen of the device on TV. The TV will switch back to the last selected programme.

From the TV

To stop watching the screen of the device on TV, you can . . .

- press **EXIT** to watch a TV broadcast
- press **Home** to start another activity on TV
- press **SOURCES** to open the Sources menu and select a connected device.

Block a Device

The first time you receive a request to connect from a device, you can block the device. The request from this device and all its requests in the future, will be ignored.

To block a device...

Select **Block...** and press **OK**.

Unblock all devices

All previously connected and also blocked devices are stored in the Wi-Fi Miracast list of connections. If you clear this list, all blocked devices will be unblocked.

To unblock all blocked devices...

Home > **Settings** > **All settings** > **Network** > **Reset Wi-Fi Miracast connections**.

Blocking a previously connected device

If you want to block a device that you previously connected, you need to clear the Wi-Fi Miracast connections list first. If you clear this list, you will have to confirm or block the connection for every device again.

Reset Wi-Fi Miracast connections

All previously connected devices are stored in the Wi-Fi Miracast list of connections.

To clear all connected Miracast devices...

Home > **Settings** > **All settings** > **Network** > **Reset Wi-Fi Miracast connections**.

Screen Delay

The normal delay when sharing a screen with Miracast is about 1 second. The delay might be longer if you are using older devices with less processing power.

Apps - Philips TV Remote App

With the TV Remote App, you master your media around you. Send photos, music or videos to your big TV screen or watch any of your TV channels live on your tablet or phone. Look up what you want to watch on the TV Guide and watch it on your phone or TV. With the TV Remote App you can use your phone as a remote control*.

Download the Philips TV Remote App from your favourite app store today.

The Philips TV Remote App is available for iOS and Android and is free of charge.

* When use your phone as a remote control, TV cannot be switched on or off via your phone.

5.6

Other Device

USB Flash Drive

You can view photos or play your music and videos from a connected USB flash drive. Insert a USB flash drive in one of the **USB** connections on the TV while the TV is switched on.

The TV detects the flash drive and opens a list showing its content.

If the contents list does not appear automatically, press **SOURCES** and select **USB**.

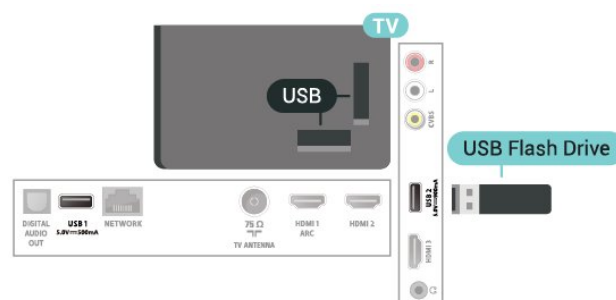

For more information on watching or playing content from a USB flash drive, in **Help**, press the colour key **Keywords** and look up **Photos, Videos and Music**.

USB Hard Drive

Installation

If you connect a USB Hard Drive, you can pause or record a TV broadcast. The TV broadcast must be a digital broadcast (DVB broadcast or similar).

Before you can pause or record a broadcast, you must connect and format a USB Hard Drive.

Formatting removes all files from the USB Hard Drive.

To Pause

To pause a broadcast, you need a USB compatible Hard Drive with a minimum of 4GB disk space.

To Record

To pause and record a broadcast, you need a minimum of 250GB disk space. If you want to record a broadcast with TV guide data from the Internet, you need to have the Internet connection installed on your TV before you install the USB Hard Drive.

1 - Connect the USB Hard Drive to one of the USB connections on the TV. Do not connect another USB device to the other USB ports when formatting.

2 - Switch on the USB Hard Drive and the TV.

3 - When the TV is tuned to a digital TV channel, press **||** (Pause). Trying to pause will start the formatting.

Follow the instructions on screen.

When the USB Hard Drive is formatted, leave it connected permanently.

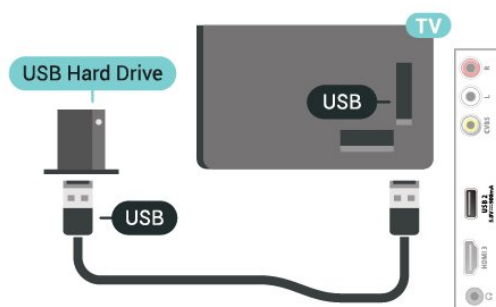

The USB Hard Drive is formatted exclusively for this TV, you cannot use the stored recordings on another TV or PC. Do not copy or change recording files on the USB Hard Drive with any PC application. This will corrupt your recordings. When you format another USB Hard Drive, the content on the former will be lost. A USB Hard Drive installed on your TV will need reformatting for use with a computer.

To format a USB Hard Drive...

1 - Connect the USB Hard Drive to one of the USB connections on the TV. Do not connect another USB device to the other USB ports when formatting.

2 - Switch on the USB Hard Drive and the TV.

3 - When the TV is tuned to a digital TV channel, press **||** (Pause). Trying to pause will start the formatting. Follow the instructions on screen.

4 - The TV will ask if you want to use the USB Hard Drive to store apps, agree to the question if you do.

5 - When the USB Hard Drive is formatted, leave it connected permanently.

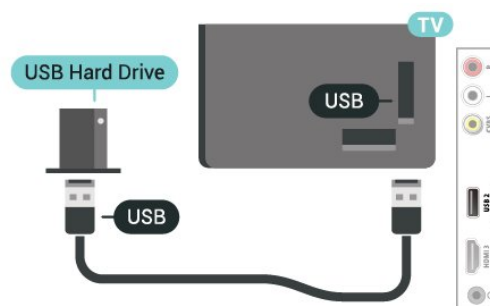

Warning

The USB Hard Drive is formatted exclusively for this TV, you cannot use the stored recordings on another TV or PC. Do not copy or change recording files on the USB Hard Drive with any PC application. This will corrupt your recordings. When you format another USB Hard Drive, the content on the former will be lost. A USB Hard Drive installed on your TV will need reformatting for use with a computer.

To read the instructions, in Help, press the colour key **■** **Keywords** and look up **USB Hard Drive**.

Formatting

Before you can pause or record a broadcast, you must connect and format a USB Hard Drive. Formatting removes all files from the USB Hard Drive. If you want to record broadcasts with TV Guide data from the Internet, you must setup the Internet connection first before you install the USB Hard Drive.

Warning

Switch Source

6.1

Source List

- To open the sources menu, press **SOURCES**.
- To switch to a connected device, select the device with the arrows **▶** (Right) or **◀** (Left) and press **OK**.
- To view the technical information of the connected device you are watching, press **≡** **OPTIONS** and select **Device info**.
- To close the source menu without switching to a device, press **SOURCES** again.

6.2

Rename Device

- Only CVBS, YPbPr, HDMI sources can be renamed or replace device icon.

⬆ (Home) > Settings > All settings > General settings > Input sources > Source > Edit

- 1 - Select one of the device icons and press **OK**, the preset name appears in the typing field.
- 2 - Press **▲** (up) to move to the typing field, press **OK**, then enter new name using on-screen keyboard.
 - Press **⬇** (red) key to enter with lower-case
 - Press **⬆** (green) key to enter with upper-case
 - Press **⬇** (yellow) key to enter number and symbol
 - Press **⬇** (blue) key to delete a character
- 3 - Select **Enter** when complete the editing.

Channels

7.1

About Channels and Switch Channels

To watch TV channels

- Press **TV**. The TV tunes to the TV channel you last watched.
- Press **Home** > **TV** > **Channels** and press **OK**.
- Press **TV+** or **TV-** to switch channels.
- If you know the channel number, type in the number with the number keys. Press **OK** after you entered the number to switch channels.
- To switch back to the previously tuned channel, press **BACK**.

To switch to a channel from a channel list

- While watching a TV channel, press **OK** to open the channel lists.
- The channel list can have several pages with channels. To view the next or previous page, press **TV+** or **TV-**.
- To close the channel lists without switching channels, press **BACK** or **TV EXIT**.

Channel icons

After an Automatic channel update of the channel list, newly found channels are marked with a **★** (star). If you lock a channel, it will be marked with a **🔒** (lock).

Radio channels

If digital broadcasting is available, digital radio stations are installed during installation. Switch to a radio channel just like you switch to a TV channel.

This TV can receive digital television standard DVB. TV may not work properly with some operators of digital television, non-compliance with requirements of the standard in full.

7.2

Install Channel

Antenna Install

Manually Search for Channels and Channel Settings

Search for Channels

Update channels

Home > **Settings** > **Install Channels** > **Antenna installation** > **Search for**

channels

- 1 - Select **Start now** and press **OK**.
- 2 - Select **Update channels** to only add new digital channels.
- 3 - Select **Start** and press **OK** to update channels. This can take a few minutes.

Quick reinstall

Home > **Settings** > **Install Channels** > **Antenna installation** > **Search for channels**

- 1 - Select **Start now** and press **OK**.
- 2 - Select **Quick reinstall** to install all channels again with default settings.
- 3 - Select **Start** and press **OK** to update channels. This can take a few minutes.

Advanced reinstall

Home > **Settings** > **Install Channels** > **Antenna installation** > **Search for channels**

- 1 - Select **Start now** and press **OK**.
- 2 - Select **Advanced reinstall** to do a full re-installation which takes you through each step.
- 3 - Select **Start** and press **OK** to update channels. This can take a few minutes.

Channel Settings

Home > **Settings** > **Install Channels** > **Antenna installation** > **Search for channels** > **Advanced reinstall**

- 1 - Select **Start now** and press **OK**.
- 2 - Select **Advanced reinstall** to do a full re-installation which takes you through each step.
- 3 - Select **Start** and press **OK**.
- 4 - Select the country where you are now and press **OK**.
- 5 - Select **Antenna (DVB-T)**, and select one item you need to re-install.
- 6 - Select **Digital and analogue channels**, **Only digital channels**, or **Only analogue channels**.
- 7 - Select **Settings** and press **OK**.
- 8 - Press **Reset** to reset, or press **Done** when complete the settings.

Frequency scan

Select the method of searching for channels.

- **Quick:** select the faster method and use the predefined settings used by most cable providers in your country.
- **Full:** If this results in having no channels installed or if some channels are missing, you can select the extended **Full** method. This method will take more time to search for and install channels.
- **Advanced:** If you received a specific network

frequency value to search for channels, select **Advanced**.

Frequency step size

The TV searches for channels in steps of **8MHz**. If this results in having no channels installed or if some channels are missing, you can search in smaller steps of **1MHz**. Using the 1MHz steps will take more time to search for and install channels.

Network frequency mode

If you intend to use the fast **Quick** method in **Frequency scan** to search for channels, select **Automatic**. The TV will use 1 of the predefined network frequencies (or HC - homing channel) as used by most cable providers in your country. If you received a specific network frequency value to search for channels, select **Manual**.

Network frequency

With the **Network frequency mode** set to **Manual**, you can enter the network frequency value received from your cable provider here. To enter the value, use the number keys.

Network ID

Enter the network ID supplied by your cable provider.

Symbol rate mode

If your cable provider did not give you a specific **symbol rate** value to install the TV channels, leave the **Symbol rate mode** setting on **Automatic**. If you received a specific symbol rate value, select **Manual**.

Symbol rate

With the **Symbol rate mode** set to **Manual**, you can enter the symbol rate value by using the number keys.

Digital: Reception Test

🏠 (Home) > Settings > Install Channels > Antenna installation > Digital: reception test

The digital frequency is shown for this channel. If the reception is poor, you can reposition your antenna. To check the signal quality of this frequency again, select **Search** and press **OK**.

To enter a specific digital frequency yourself, use the remote control digit keys. Alternatively, select the frequency, position the arrows on a number with **◀** and **▶** and change the number with **▲** and **▼**. To check the frequency, select **Search** and press **OK**.

Analogue: Manual Installation

🏠 (Home) > Settings > Install Channels > Antenna installation > Analogue: manual installation

Analogue TV channels can be manually installed, channel by channel.

• System

To set up the TV system, select **System**. Select your country or the part of the world where you are now and press **OK**.

• Search Channel

To find a channel, select **Search Channel** and press **OK**. You can enter a frequency yourself to find a channel or let the TV search for a channel. Press **OK**, select **Search** and press **OK** to search for a channel automatically. The found channel is shown on screen and if the reception is poor, press **Search** again. If you want to store the channel, select **Done** and press **OK**.

• Fine tune

To fine tune a channel, select **Fine tune** and press **OK**. You can fine tune the channel with **▲** or **▼**.

If you want to store the channel found, select **Done** and press **OK**.

• Store

You can store the channel on the current channel number or as a new channel number. Select **Store** and press **OK**. The new channel number is shown briefly.

You can redo these steps until you have found all available analogue TV channels.

Channel List copy

Introduction

Channel list copy is intended for dealers and expert users.

With **Channel list copy**, you can copy the channels installed on one TV onto another Philips TV of the same range. With **Channel list copy**, you avoid the time-consuming channel search by uploading a predefined channel list on a TV. Use a USB flash drive of minimum 1 GB.

Conditions

- Both TVs are from the same year range.
- Both TVs have the same hardware type. Check the hardware type on the TV type plate on the back of

the TV.

- Both TVs have compatible software versions.

Copy a Channel List, Check Channel List Version

Copy a channel list to USB flash drive

🏠 (Home) > Settings > All settings > Channels > Expert mode settings > Channel list copy > Copy to USB

Check channel list version

🏠 (Home) > Settings > All settings > Channels > Expert mode settings > Channel list copy > Current version

Upload a Channel List

To not Installed TVs

Depending on whether your TV is already installed or not, you must use a different method to upload a channel list.

To a TV that is not yet installed

- 1 - Plug in the power plug to start the installation and select language and country. You can skip the channel search. Finish the installation.
- 2 - Plug in the USB flash drive that holds the channel list of the other TV.
- 3 - To start the channel list upload, press 🏠 (Home) > Settings > All settings > Channels > Expert mode settings > Channel List Copy > Copy to TV and press OK. Enter your PIN code if necessary.
- 4 - The TV notifies you if the channel list is copied to the TV successfully. Unplug the USB flash drive.

To Installed TVs

Depending on whether your TV is already installed or not, you must use a different method to upload a channel list.

To an already installed TV

- 1 - Verify the country setting of the TV. (To verify this setting, see chapter **Re-install channels**. Start this procedure until you reach the country setting. Press ⬅ **BACK** to cancel the installation.) If the country is correct continue with step 2. If the country is not correct, you need to start a reinstallation. See chapter **Re-install channels** and start the installation. Select the correct country and skip the channels search. Finish the installation. When done, continue with step 2.
- 2 - Plug in the USB flash drive that holds the channel list of the other TV.

- 3 - To start the channel list upload, press 🏠 (Home) > Settings > All settings > Channels > Expert mode settings > Channel List Copy > Copy to TV and press OK. Enter your PIN code if necessary.
- 4 - The TV notifies you if the channel list is copied to the TV successfully. Unplug the USB flash drive.

Channel Options

Open Options

While watching a channel, you can set some options.

Depending on the type of channel you are watching or depending on the TV settings you made, some options are available.

To open the options menu...

- 1 - While watching a channel, press ≡ **OPTIONS**.
- 2 - Press ≡ **OPTIONS** again to close.

Programme info

Select **Programme info** to view the information of the programme you are watching.

Subtitles

To switch on Subtitles, press ≡ **OPTIONS** and select **Subtitles**.

You can switch subtitles **Subtitle on** or **Subtitle off**. Alternatively you can select **Automatic**.

Automatic

If language information is part of the digital broadcast and the broadcasted programme is not in your language (the language set on TV), the TV can show subtitles automatically in one of your preferred subtitle languages. One of these subtitle languages must also be part of the broadcast.

You can select your preferred subtitle languages in **Subtitle language**.

Subtitles Language

If none of the preferred subtitle languages are available, you can select another subtitle language if available. If no subtitle languages are available, you cannot select this option.

To read more information, in Help, press the colour key **Keywords** and look up **Subtitle Language**.

Audio Language

If none of the preferred audio languages are available, you can select another audio language if available. If no audio languages are available, you cannot select this option.

To read more information, in Help, press the colour key **red** **Keywords** and look up **Audio Language**.

Dual I-II

If an audio signal contains two audio languages but one language or both has no language indication, this option is available.

Mono / Stereo

You can switch the sound of an analogue channel to Mono or Stereo.

To switch to Mono or Stereo...

Tune to an analogue channel.

1 - Press **≡** **OPTIONS**, select **Mono/Stereo** and press **➤** (right).

2 - Select **Mono** or **Stereo** and press **OK**.

3 - Press **◀** (left) repeatedly if necessary, to close the menu.

Channel info

Select **Channel info** to view the technical information of the channel.

HbbTV on This Channel

If you want to avoid access to HbbTV pages on a specific channel, you can block the HbbTV pages for this channel only.

1 - Tune to the channel of which you want to block the HbbTV pages.

2 - Press **≡** **OPTIONS** and select **HbbTV on this channel** and press **➤** (right).

3 - Select **Off** and press **OK**.

4 - Press **◀** (left) to go back one step or press **←** **BACK** to close the menu.

To block HbbTV on TV completely...

⬆ (Home) > **Settings** > **All settings** > **Channels**
> **HbbTV** > **Off**

Universal Access

Only available when **Universal access** set to **On**.

⬆ (Home) > **Settings** > **All settings** > **Universal access** > **Universal access** > **On**.

To read more information, in Help, press the colour key **red** **Keywords** and look up **Universal Access**.

Video Selection

Digital TV channels can offer multi video signals (multi-feed broadcast), different camera viewpoints or angles of the same event or different programmes on one TV channel. The TV shows a message if any such TV channels are available.

7.3

Channel List

Open Channel List

To open the current channel list...

1 - Press **tv**, to switch to TV.

2 - Press **OK** to open the current channel list.

3 - Press **≡** **OPTIONS** > **Select channel list**, or long press **≡** **TV Guide** to open the channel list.

4 - Select one channel list you want to watch.

5 - Press **←** **BACK** to close the channel list.

Channel List Options

Open Option Menu

To open the channel list option menu...

• Press **tv**, to switch to TV.

• Press **OK** to open the current channel list.

• Press **≡** **OPTIONS**, and select one of options.

• Press **←** **BACK** to close the channel list.

Rename Channel

1 - Press **tv**, to switch to TV.

2 - Press **OK** to open the current channel list.

3 - Select one channel you want to rename.

4 - Press **≡** **OPTIONS** > **Rename channel**, and press **OK**.

5 - In the typing field, press **OK** to open on-screen keyboard, or press **←** **BACK** to hide the on-screen keyboard.

6 - Use navigation keys to select a character, then press **OK**.

- Press **red** (red) key to enter with lower-case

- Press **green** (green) key to enter with upper-case

- Press **■** (yellow) key to enter number and symbol
- Press **■** (blue) key to delete a character
- 7 - Select **Done** when complete the editing.
- 8 - Press **← BACK** to close the channel list.

Select Channel Filter

- 1 - Press **TV**, to switch to TV.
- 2 - Press **OK** to open the current channel list.
- 3 - Press **≡ OPTIONS** > **Digital/analogue**
- 4 - Select one of channel combinations showing in the channel list.

Create or Edit Favourites Channel List

- TV** **OK** > **≡ OPTIONS** > **Create favourites list**

Select a channel then press **OK** to add in a favourites channel list, once completed, press **■ Done**.

- TV** **OK** > **≡ OPTIONS** > **Edit favourites**

Select a channel then press **OK** to add in or remove from a favourites channel list, once completed, press **■ Done**.

Select Channel Range

- TV** **OK** > **≡ OPTIONS** > **Select channel range**

Select a range of channels in a favourites channel list, once completed, press **OK**.

Select Channel List

- TV** **OK** > **≡ OPTIONS** > **Select channel list**

Select a range of channels in a favourites channel list, once completed, press **OK**.

Search Channels

- TV** **OK** > **≡ OPTIONS** > **Search channel**

You can search for a channel to find it in a long list of channels.

- 1 - Press **TV**, to switch to TV.
 - 2 - Press **OK** to open the current channel list.
 - 3 - Press **≡ OPTIONS** > **Search channel**, and press **OK**.
 - 4 - In the typing field, press **OK** to open on-screen keyboard, or press **← BACK** to hide the on-screen keyboard.
 - 5 - Use navigation keys to select a character, then press **OK**.
- Press **■** (red) key to enter with lower-case

- Press **■** (green) key to enter with upper-case
- Press **■** (yellow) key to enter number and symbol
- Press **■** (blue) key to delete a character
- Select **Enter** to start the searching
- 6 - Select **■ Done** when the searching is completed.
- 7 - Press **← BACK** to close the channel list.

Lock or Unlock Channel

- TV** **OK** > **≡ OPTIONS** > **Lock channel, Unlock channel**

To prevent children from watching a channel, you can lock a channel. To watch a locked channel, you must enter the 4 digit **Child Lock PIN** code first. You cannot lock programmes from connected devices.

The locked channel will have **🔒** next to the channel logo.

Remove Favourite List

- TV** **OK** > **≡ OPTIONS** > **Remove favourite list**

To remove existing favourite list, select **Yes**.

7.4

Favourite Channels



About Favourite Channels

You can create a favourite channel list that only holds the channels you want to watch. With the Favourite channel list selected, you will only see your favourite channels when you switch through channels.

Create a Favourites List



- 1 - While watching a TV channel, press **OK** to open the channel list.
- 2 - Select the channel, and press **■ Mark as favourites** to mark as favourite.
- 3 - The selected channel is marked with a **♥**.
- 4 - To finish, press **← BACK**. The channels are added to the Favourites list.

Remove Channel from the Favourites List

To remove a channel from the favourites list, select the channel with , then press  **Unmark as favourite** again to unmark as favourite.



Reorder Channels

You can reorder — reposition — channels in the Favourite channel list.

- 1 - While watching a TV channel, press **OK** >  **OPTIONS** > **Select channel list**.
- 2 - Select **Antenna favourite**, and press  **OPTIONS**.
- 3 - Select **Reorder channels**, select the channel you want to reorder, and press **OK**.
- 4 - Press the **Navigation buttons** to move the highlighted channel to another location and press **OK**.
- 5 - Once completed, press  **Done**.

Favourites List on TV Guide

You can link the TV Guide for your Favourite List.

- 1 - While watching a TV channel, press **OK** >  **OPTIONS** > **Select channel list**.
- 2 - Select **Antenna favourite**, and press **OK**.
- 3 - Press  **TV GUIDE** to open it.

With the TV Guide you can view a list of the current and scheduled TV programmes of your favourite channels. Along with your favourite channels, the first 3 most used channels from the broadcasters' default list will be appended after your favourite channels for your preview. You need to add these channels into your favourite list to enable its operation (refer to "TV Guide" chapter).

On each page of TV Guide, there is a "Did you know" grid inserted on your favourite channel list. The "Did you know"-channel provides useful tips to improve the way you use your TV.

7.5

Text / Teletext

Subtitles from Text

If you tune to an analogue channel, you need to make the subtitles available for each channel manually.

- 1 - Switch to a channel and press **TEXT** to open Text.
- 2 - Enter the page number for subtitles, usually **888**.
- 3 - Press **TEXT** again, to close Text.

If you select **On** in the Subtitle menu when watching this analogue channel, subtitles will be shown if available.

To know if a channel is analogue or digital, switch to the channel and press  **INFO**.

Text Pages

To open Text/Teletext press **TEXT**, while you are watching TV channels.

To close Text, press **TEXT** again.

Select a Text page

To select a page . . .

- 1 - Enter the page number with the number keys.
- 2 - Use the arrow keys to navigate.
- 3 - Press a colour key to select a colour-coded subject at the bottom of the screen.

Text sub-pages

A Text page number can hold several subpages. The subpage numbers are shown on a bar next to the main page number.

To select a subpage, press **<** or **>**.

T.O.P. Text pages

Some broadcasters offer T.O.P. Text.

To open T.O.P. Text pages within Text, press  **OPTIONS** and select **T.O.P. overview**.

* The teletext can only be reached when the channels are installed directly on the TV's internal tuner and the set is on TV mode. If a set-top box is being used, the teletext will be unavailable via TV. In that case, the set-top box's teletext can be used instead.

Text Options

In Text/Teletext, press  **OPTIONS** to select the following...

- **Freeze page**

To stop the automatic rotation of subpages.

- **Dual screen / Full screen**

To show the TV channel and Text alongside each other.

- **T.O.P. overview**

To open T.O.P. Text.

- **Enlarge**

To enlarge the Text page for comfortable reading.

- **Reveal**

To unhide hidden information on a page.

- **Language**

To switch the group of characters that Text uses to display correctly.

- **Text 2.5**

To activate the Text 2.5 for more colours and better graphics.

Text Setup

Text language

Some digital TV broadcasters have several Text languages available.

Set teletex preference language

🏠 (Home) > Settings > All settings > Region and language > Language > Primary text, Secondary text

Text 2.5

If available, Text 2.5 offers more colours and better graphics. Text 2.5 is activated as a standard factory setting.

To switch off Text 2.5...

1 - Press **TEXT**.

2 - With Text/Teletext open on screen, press **≡** **OPTIONS**.

3 - Select **Text 2.5 > Off**.

4 - Press **◀** (left) repeatedly if necessary, to close the menu.

TV Guide

8.1

What You Need

With the TV guide you can view a list of the current and scheduled TV programmes of your channels. Depending on where the TV guide information (data) is coming from, analogue and digital channels or only digital channels are shown. Not all channels offer TV guide information.

The TV can collect TV guide information for the channels that are installed on the TV (e.g the channels you watch with Watch TV). The TV cannot collect the TV guide information for channels viewed from a digital receiver.

8.2

Using the TV Guide

Open the TV Guide

To open the TV guide, press **≡ TV GUIDE**.

Press **≡ TV GUIDE** again to close.

The first time you open the TV Guide, the TV scans all TV channels for programme information. This may take several minutes. TV guide data is stored on TV.

Tune to a Programme

Switch to a programme

- From the TV guide, you can switch to a current programme.
- To select a programme, use the arrow keys to highlight the programme name.
- Navigate to the right to view programmes scheduled later that day.
- To switch to the programme (channel), select the programme and press **OK**.

View programme details

To call up the details of the selected programme, press **ⓘ INFO**.

Change Day

If the TV guide information comes from the broadcaster, you can press **TV +** to view the schedule of one of the next days. Press **TV -** to go back to the previous day.

Alternatively, you can press **≡ OPTIONS** and select **Change day**.

Set a Reminder

You can set a reminder for a programme. A message will alert you at the start of the programme. You can tune to this channel immediately.

In the TV Guide a programme with a reminder is marked with a **🕒** (clock).

To set a reminder...

- 1 - Press **≡ TV GUIDE** and select an upcoming programme.
- 2 - Press **🕒** Set reminder and press **OK**.

To clear a reminder...

- 1 - Press **≡ TV GUIDE** and select a programme with the reminder, which is marked with a **🕒** (clock).
- 2 - Press **🕒** Clear reminder, and select **Yes**, then press **OK**.

Search by Genre

If the information is available, you can look up scheduled programmes by genre like movies, sports, etc.

To search for programmes by genre, press **≡ OPTIONS** and select **Search by genre**. Select a genre and press **OK**. A list with the found programmes appears.

List of Reminders

You can view a list of the reminders you have set.

List of Reminders

To open the list of reminders...

- 1 - Press **≡ TV GUIDE**.
- 2 - Press **≡ OPTIONS** and select **All reminders**.
- 3 - In the list of reminders, select the reminder you want to remove, the selected reminder is marked as **✓**.
- 4 - Select **Clear selected** and press **OK**.
- 5 - Select **Close** to close the list of reminders.

Set a Recording

You can set a recording in the TV Guide.

To record a programme...



1 - Press  TV GUIDE and select a future or ongoing programme.

2 - Press the colour key  Record .

To cancel a recording...

1 - Press  TV GUIDE and select the programme set for recording.

2 - Press the colour key  Clear recording .

To see the recording list, press  Recordings , a programme set to be recorded is marked with a  (red dot) on the front of the programme name.

Recording and Pause TV

9.1

Recording

What You Need

You can record a digital TV broadcast and watch it later.

To record a TV programme you need...

- a connected USB Hard Drive formatted on this TV
- digital TV channels installed on this TV
- to receive channel information for the on screen TV Guide
- a reliable TV clock setting. If you reset the TV clock manually, recordings may fail.

You cannot record when you are using Pause TV.

In terms enforcement of copyright legislation, some DVB providers can apply different restriction by means of DRM (Digital Right Management) technology. In case of broadcasting protected channels, recording, record validity or number of views may be restricted. Recording may be completely prohibited. In case of trying to record a protected broadcasting or play back an expired recording, an error message can appear.

Record a Programme

Record Now

To record the programme you are watching right now, press **●** (Record) on the remote control. The recording will start immediately.

To stop the recording, press **■** (Stop).

When TV Guide data is available, the programme you are watching will be recorded from the moment you pressed the recording key until the programme ends.

- If you receive TV guide information from the broadcaster, the recording starts immediately. You can adjust the end time of the recording in the list of recordings.

Schedule a Recording

You can schedule a recording of an upcoming programme for today or a few days from today (maximum of 8 days away). The TV will use the data from the TV Guide to start and end the recording.

To record a programme...

- 1 - Press **≡** TV GUIDE.
- 2 - On the TV guide, select the channel and programme you wish to record. Press **➤** (Right) or **➤** (Left) to scroll through the programmes of a channel.
- 3 - With the programme highlighted, press the colour key **■** Record . The programme is scheduled for recording. A warning will show automatically when overlapping recordings are scheduled. If you plan to record a programme in your absence, remember to leave the TV switched to Standby and the USB Hard Drive switched on.

List of Recordings

You can view and manage your recordings in the list of recordings. Next to the list of recordings, there is a separate list for scheduled recordings and reminders.

To open the list or recordings...

Press **≡** TV GUIDE.

- 1 - Press the colour key **■** Recordings .
- 2 - In the list of recordings, select the tabs **New**, **Watched** or **Expired** and press **OK** to filter your view.
- 3 - With a recording selected in the list, you can remove the recording with the colour key **■** Remove . You can rename a recording with the colour key **■** Rename .

Broadcasters can limit the number of days a recording can be viewed. When this period expires, the recording will be marked as expired. A recording in the list can show the number of days before it expires.

When a scheduled recording was prevented by the broadcaster or when the broadcast was interrupted, a recording is marked as **Failed**.

Manual recording

You can schedule a recording that is not linked to a TV programme. You set the tuner type, channel and the start and end time yourself.

To schedule a recording manually...

- 1 - Press **≡** TV GUIDE.
- 2 - Press the colour key **■** Recordings .
- 3 - Press the colour key **■** Schedule and press **OK**.
- 4 - Select the tuner from where you want to record and press **OK**.
- 5 - Select the channel to record from and press **OK**.
- 6 - Select the day of the recording and press **OK**.
- 7 - Set the start and end time of the recording. Select a button and use the **▲** (up) or **▼** (down) keys to set the hours and minutes.

8 - Select **Schedule** and press **OK** to schedule the manual recording.

The recording will appear in the list of scheduled recordings and reminders.

Watch a Recording

To watch a recording...

- 1 - Press **TV GUIDE**.
- 2 - Press the colour key **Recordings**.
- 3 - In the list of recordings, select the recording you need and press **OK** to start watching.
- 4 - You can use the keys **||** (pause), **▶** (play), **◀◀** (rewind), **▶▶** (fast forward) or **■** (stop).
- 5 - To switch back to watch TV, press **TV EXIT**.

9.2

Pause TV

What You Need

To pause a TV programme you need...

- a connected USB Hard Drive formatted on this TV
- digital TV channels installed on this TV
- to receive channel information for the on screen TV guide

With the USB Hard Drive connected and formatted, the TV continuously stores the TV broadcast you are watching. When you switch to another channel, the broadcast of the former channel is cleared. Also when you switch the TV to standby the broadcast is cleared.

You cannot use Pause TV when you are recording.

Pause a Programme

To pause and resume a broadcast...

- To pause a broadcast, press **||** (Pause). A progress bar at the bottom of the screen appears briefly.
- To call up the progress bar, press **||** (Pause) again.
- To resume watching, press **▶** (Play).

With the progress bar on screen, press **◀◀** (Rewind) or press **▶▶** (Forward) to select from where you want to start viewing the paused broadcast. Press these keys repeatedly to change speed.

To switch back to the actual TV broadcast, press **■** (Stop).

Replay

Since the TV stores the broadcast you are watching, you can mostly replay the broadcast for a few seconds.

To replay a current broadcast...

- 1 - Press **||** (Pause)
- 2 - Press **◀◀** (Rewind). You can press **◀◀** repeatedly to select from where you want to start viewing the paused broadcast. Press these keys repeatedly to change speed. At one point you will reach the start of the broadcast storage or the maximum time span.
- 3 - Press **▶** (Play) to watch the broadcast again.
- 4 - Press **■** (Stop) to watch the broadcast live.

Videos, Photos and Music

From a USB Connection

You can view your photos or play your music and videos from a connected USB flash drive or USB Hard Drive.

With the TV switched on, plug in a USB flash drive or a USB Hard Drive to one of the USB connections.

Press **SOURCES**, then select **USB**, you can browse your files in folder structure you have organised on the USB Hard Drive.

Warning

If you try to pause or record a programme with a USB Hard Drive connected, the TV will ask you to format the USB Hard Drive. This formatting will delete all current files on the USB Hard Drive.

Photos

View Photos

1 - Press **SOURCES**, select **USB** and press **OK**.

2 - Select **USB Flash Drive** and press **>** (right) to select the USB device you need.

3 - Select **Photo**, you can press **Sort** to browse your photos by date, month, year or alphabetically by name.

4 - Select one of photos, and press **OK** to view the selected photo.

- To view photos, select **Photos** in the menu bar, select a photo thumbnail and press **OK**.
- If there are several photos in the same folder, select a photo and press **Slide show** to start a slide show of all photos in this folder.
- Watch a photo and press **INFO** to show below: Progress bar, Playback control bar, **◀** (Jump to the previous photo in a folder), **▶** (Jump to the next photo in a folder), **▶** (Start slideshow playback), **||** (Pause the playback), **▶** (Start slideshow), **▶** (Rotate photo)

Photo Options

With a photo on screen, press **≡** **OPTIONS** to...

List/Thumbnails

View photos with list view or thumbnails view.

Shuffle off, Shuffle on

View the pictures in sequential order, or at random.

Repeat, Play once

View the pictures repeatedly or once only.

Stop music

Stop the music if the music playback is in progress.

Slideshow speed

Set the speed of the slideshow.

Slideshow transitions

Set the transition from one picture to the next.

360 Photo

View 360 Photos

1 - Press **SOURCES**, select **USB** and press **OK**.

2 - Select **USB Flash Drive** and press **>** (right) to select the USB device you need.

3 - Select **360 Photos**, you can press **Sort** to browse your 360 photos by date, month, year or alphabetically by name.

4 - Select one of 360 photos, and press **OK** to view the selected 360 photo.

- To view photos, select **360 Photos** in the menu bar, select a photo thumbnail and press **OK**.
- If there are several 360 photos in the same folder, select a 360 photo and press **Slide show** to start a slide show of all 360 photos in this folder.
- Watch a photo and press **INFO** to show below: Progress bar, Playback control bar, **◀** (Jump to the previous photo in a folder), **▶** (Jump to the next photo in a folder), **▶** (Start slideshow playback), **||** (Pause the playback), **▶** (Play all/Play one), **▶** (Little Planet), **▶** (Auto Mode/Manual mode).

- Little Planet: Little Planet is an alternate and fun view of 360 photo. When Little Planet view is started, the 360 photo will be rendered in a wrapped around view like a planet.

- Auto Mode/Manual mode: when the 360 player is started, it will auto pan the selected 360 photo from left to right (0 to 360 degrees) in 360 view. When manual mode is entered, the 360 player will stop auto panning/rotating to allow manually panning/rotating with the remote control keys.

360 Photo Options

With a 360 photo on screen, press  **OPTIONS** to...

List/Thumbnails

View 360 photos with list view or thumbnails view.

Shuffle off, Shuffle on

View the pictures in sequential order, or at random.

Repeat, Play once

View the pictures repeatedly or once only.

Stop music

Stop the music if the music playback is in progress.





10.4

Videos

Play Videos



To play a video on TV...

Select  **Videos**, and select the file name and press **OK**.

- To pause the video, press **OK**. Press **OK** again to continue.
- To rewind or go fast forward, press  or . Press the keys several times to speed up - 2x, 4x, 8x, 16x, 32x.
- To jump to the next video in a folder, press **OK** to pause and select  on screen and press **OK**.
- To stop the video playback, press  (Stop).
- To go back to the folder, press .

Open video folder



1 - Press  **SOURCES**, select  **USB** and press **OK**.







2 - Select  **USB Flash Drive** and press  (right) to select the USB device you need.

3 - Select **Videos** and select one of video, you can press **OK** to play the selected video.

• Select a video and press  **INFO** to show file information.

• Playback a video and press  **INFO** to show below:

Progress bar, Playback control bar,  (Jump to the previous video in a folder),  (Jump to the next video in a

folder),  (Playback),  (Rewind),  (Fast forward),  (Pause the playback),  (Play all/Play one),  (Shuffle on/Shuffle off)

Video Options

During the video playback, press  **OPTIONS** to...

List/Thumbnails

View video files with list view or thumbnails view.

Subtitles

Display the subtitles if available, select **On**, **Off**, or **On during mute**.

Shuffle off, Shuffle on

Play videos in sequential order, or at random.

Repeat, Play once

Play videos repeatedly or once.



10.5

Music

Play Music

Open music folder







1 - Press  **SOURCES**, select  **USB** and press **OK**.

2 - Select  **USB Flash Drive** and press  (right) to select the USB device you need.

3 - Select **Music** and select one of music, you can press **OK** to play the selected music.

• Select a music and press  **INFO** to show file information.

• Playback a music and press  **INFO** to show below:

Progress bar, Playback control bar,  (Jump to the previous music in a folder),  (Jump to the next music in a folder),  (Playback),  (Rewind),  (Fast forward),  (Pause the playback),  (Play all/Play one)

Music Options

During the music playback, press  **OPTIONS** to...

Shuffle off, Shuffle on

Play songs in sequential order, or at random.

Repeat, Play once

Play songs repeatedly or once.

Open TV Setting Menus

Home Menu Overview

Press **⬆** (Home) to select one of below menus, then press OK.

Sources

This row contains available sources in this TV.

Watch TV

This row contains TV functions which are available for user.

Apps

This row contains number of apps pre-installed.

Search

This row contains an interface to perform the search within this TV.

Settings

This row contains settings which are available for user.

You can reorder the icons on Home menus. To reposition icons, press OK. Alternatively, you can select the icon you want to reorder, and hold the OK key for 3 seconds until the arrows appear around the icon. Use navigation keys to move the highlighted icon to another location, then press OK. Press the BACK key to exit.

Frequent settings and All settings

Settings menu:

Press **⬆** (Home) > Settings key on the remote control to find frequent settings.

- How to - Instructions on how to install channels, sort channels, update TV software, connect external devices and use Smart functions on your TV.
- Install channels - Update channels or start a complete new channel installation.
- Picture style - Select one of preset picture styles for ideal picture viewing.
- Picture format - Select one of preset picture format which fits the screen.
- Sound style - Select one of preset sound styles for

ideal sound settings.

- Audio out - Set the TV to play the sound on TV or on the connected audio system.
- Ambilight style* - Select one of preset Ambilight styles.
- Ambilight+hue* - Switch Ambilight+hue on or off.
- Sleep timer - Set the TV to switch to standby automatically after a preset time.
- Screen off - If you only listen to music on TV, you can switch off the TV screen.

- Wireless and networks - Connect to your home network or adjust the network settings.
- Picture settings - Adjust all picture settings.
- All settings - View all settings menu.
- Help - Diagnose and get more information about your TV. For more information, in Help, press the colour key **■** Keywords and look up Help Menu for more information.

All settings menu:

Press **⬆** (home) key on the remote control, select Settings > All settings, and press OK.

* Ambilight setting is only for models which support Ambilight function.

All Settings

Picture Settings

Picture Style

Select a style

For easy picture adjustment, you can select a preset picture style.

⬆ (Home) > Settings > Picture style, press OK to change to next available option.

The available Picture styles are ...

- Personal - The picture preferences you set during the first start up
- Vivid - Ideal for daylight viewing
- Natural - Natural picture settings
- Standard - Most energy conscious setting
- Movie - Ideal for watching movies with original studio effect
- Game - Ideal for gaming*
- Monitor - Ideal for computer monitor**

* Picture style - Game is not available for some video sources.

** Picture style - Monitor is only available when HDMI source video is applicable for PC application. HDR is

not supported in Monitor mode. The TV is able to play HDR video in Monitor mode but no HDR processing will be applied.

Custom a style

You can adjust and stored picture settings in in the currently selected picture style, like Colour, Contrast or Sharpness.

Restore a style

To restore the style to its original setting, go to **🏠 (Home) > Settings > All settings > Picture > Picture style**, then press **⏪ Restore style**.

- The TV can play HDR programmes from any one of HDMI connections, broadcasting, from an Internet source (e.g. Netflix) or from a connected USB memory device.
- The TV will automatically switched to HDR mode with indication. TV supports following HDR formats: Hybrid Log Gamma, HDR10, HDR10+, and Dolby Vision but it is subject to the availability of such HDR format in content providers.

For HDR content (Hybrid Log Gamma, HDR10 and HDR10+)

The styles for HDR (Hybrid Log Gamma, HDR10 and HDR10+) content are...

- HDR Personal
- HDR Vivid
- HDR Natural
- HDR Movie
- HDR Game

For Dolby Vision HDR content

The styles for Dolby Vision HDR content are...

- HDR Personal
- HDR Vivid
- Dolby Vision Bright
- Dolby Vision Dark
- HDR Game

Colour, Contrast, Sharpness, Brightness

Adjust the picture colour

🏠 (Home) > Settings > All settings > Picture > Colour

Press the arrows **▲ (up)** or **▼ (down)** to adjust the colour saturation value of the picture.

Adjust the picture contrast

🏠 (Home) > Settings > All settings > Picture > Contrast

Press the arrows **▲ (up)** or **▼ (down)** to adjust the contrast value of the picture.

You can decrease contrast value to reduce power consumption.

Adjust the picture sharpness

🏠 (Home) > Settings > All settings > Picture > Sharpness

Press the arrows **▲ (up)** or **▼ (down)** to adjust the sharpness value of the picture.

Adjust the picture brightness

🏠 (Home) > Settings > All settings > Picture > Brightness

Press the arrows **▲ (up)** or **▼ (down)** to set the level of brightness of the picture signal.

Note: Setting of brightness much away from reference value (50) may result lower contrast.

Expert mode picture settings

Colour Settings

🏠 (Home) > Settings > All settings > Picture > Expert mode settings

Adjust the tint setting

🏠 (Home) > Settings > All settings > Picture > Expert mode settings > Tint

Press the arrows **▲ (up)** or **▼ (down)** to adjust the value of tint setting.

Adjust the colour enhancement

🏠 (Home) > Settings > All settings > Picture > Expert mode settings > Colour enhancement

Select **Maximum**, **Medium**, or **Minimum** to set the level of the colour intensity and the details in bright colours.

Select the preset colour temperature

🏠 (Home) > Settings > All settings > Picture > Expert mode settings > Colour temperature

Select **Normal**, **Warm**, or **Cool** to set the colour temperature for your preference.

Customise colour temperature

🏠 (Home) > Settings > All settings > Picture > Expert mode settings > Colour temperature > Custom colour temperature

Select **Custom** in Colour temperature menu to customise a colour temperature yourself. Press the arrows **▲** (up) or **▼** (down) to adjust the value.

Contrast Settings

Contrast Modes

🏠 (Home) > Settings > All settings > Picture > Expert mode settings > Contrast mode

Select **Normal**, **Optimized for picture**, **Optimized for energy saving** to set the TV automatically reduces the contrast, for best power consumption or for best picture experience, or select **Off** to switch off the adjustment.

HDR Settings

🏠 (Home) > Settings > All settings > Picture > Expert mode settings > HDR Plus

Set HDR Plus to **Off**, **Minimum**, **Medium**, **Maximum** or **Automatic** to set the level at which the TV automatically shows superior contrast and brightness effect for HDR content.

Note: Available when HDR (High-Dynamic Range) signal is detected.

- The TV can play HDR programmes from any one of HDMI connections, broadcasting, from an Internet source (e.g. Netflix) or from a connected USB memory device.
- The TV will automatically switched to HDR mode with indication. TV supports following HDR formats: Hybrid Log Gamma, HDR10, HDR10+, and Dolby Vision but it is subject to the availability of such HDR format in content providers.

Dynamic Contrast

🏠 (Home) > Settings > All settings > Picture > Expert mode settings > Dynamic contrast

Select **Maximum**, **Medium**, or **Minimum** to set the level at which the TV automatically enhances the details in the dark, middle and light areas of the picture.

Video Contrast, Gamma

Video contrast

🏠 (Home) > Settings > All settings > Picture > Expert mode settings > Video contrast

Press the arrows **▲** (up) or **▼** (down) to adjust the video contrast level.

Gamma

🏠 (Home) > Settings > All settings > Picture > Expert mode settings > Gamma

Press the arrows **▲** (up) or **▼** (down) to set a non-linear setting for picture luminance and contrast.

Ultra Resolution

🏠 (Home) > Settings > All settings > Picture > Expert mode settings > Ultra resolution

Select **On** to have a superior sharpness in line edges and details.

Picture Clean

Noise reduction

🏠 (Home) > Settings > All settings > Picture > Expert mode settings > Noise reduction

Select **Maximum**, **Medium**, **Minimum** to set the level for removing the noise in video content. Noise is mostly visible as small moving dots in on-screen picture.

MPEG Artefact Reduction

🏠 (Home) > Settings > All settings > Picture > Expert mode settings > MPEG Artefact Reduction

Select **Maximum**, **Medium**, **Minimum** to have different degrees of smoothing the artefacts in digital video content.

MPEG artefacts are mostly visible as small blocks or jagged edges in on-screen images.

Motion Settings

Motion Styles

🏠 (Home) > Settings > All settings > Picture > Expert mode settings > Motion Styles

Motion styles provides optimised motion setting modes for different video content.

Select **Off** to switch off or select one of the motion styles to have different viewing experience on motion video.

(Movie, Sports, Standard, Smooth or Personal)

Not available for below cases:

• 🏠 (Home) > Settings > All settings > Picture style > Game.

• 🏠 (Home) > Settings > All settings > Picture style > Monitor.

Natural Motion

🏠 (Home) > Settings > All settings > Picture > Expert mode settings > Natural Motion

Natural Motion makes any movement smooth and fluent.

• Select **Maximum**, **Medium**, **Minimum** to have different degrees for reducing the motion judder, visible in movies on TV.

• Select **Minimum** or **Off** when noise appears in playing moving picture on-screen.

Note: Only available when **Motion styles** set to **Personal**.

Picture Format

🏠 (Home) > Settings > All settings > Picture > Picture format

If the picture is not filling the whole screen, if black bars are showing on the top or bottom or at both sides, you can adjust the picture to fill the screen completely.

To select one of the basic settings to fill the screen...

• **Wide screen** – automatically zooms in the picture to 16:9 full screen. Picture content aspect ratio may change.

• **Fill screen** – automatically enlarges the picture to fill the screen. Picture distortion is minimal, subtitles remain visible. Not suitable for PC input. Some extreme picture formats can still show black bars. Picture content aspect ratio may change.

• **Fit to screen** – automatically zooms in the picture to fill the screen without distortion. Black bars may be visible. Not supported for PC input.

• **Original** – automatically zooms in the picture to fit the screen with original aspect ratio. No content lost visible.

🏠 (Home) > Settings > All settings > Picture > Picture format > Advanced

To format the picture manually...

• **Shift** – select on the arrows to shift the picture. You can only shift the picture when it is zoomed in.

• **Zoom** – select on the arrows to zoom in.

• **Stretch** – select on the arrows to stretch the picture vertically or horizontally.

• **Undo** – select to return to the picture format you started with.

Dolby Vision Notification

🏠 (Home) > Settings > All settings > Picture > Dolby Vision Notification

Switch **On** or **Off** the Dolby Vision notification when Dolby Vision content begins to play on your TV.

Quick Picture Settings

🏠 (Home) > Settings > All settings > Picture > Quick picture settings

• During the first installation, you did some picture settings in a few easy steps. You can redo these steps with **Quick picture settings** menu.

• Select the picture setting you prefer and go to the next setting.

• To do these steps, make sure the TV can tune to a TV channel or can show a programme from a connected device.

Sound Settings

Sound Style

Select a style

For easy sound adjustment, you can select a preset sound style.

🏠 (Home) > Settings > All settings > Sound > Sound style

The available sound styles are ...

• **AI mode** - Select **AI mode** for intelligent switching of sound style based on audio content.

• **Original** - Most neutral sound setting

• **Movie** - Ideal for watching movies

• **Music** - Ideal for listening to music

• **Game** - Ideal for gaming

• **News** - Ideal for speech

• **Personal mode** - Select to check more advanced sound settings

Restore Personal mode

- 1 - Set the sound style to Personal mode.
- 2 - Press the colour key **■ Restore Style**, and press OK. The style is restored.

Customise Personal style

- 1 - Set the sound style to Personal mode.
- 2 - Press the colour key **■ Customise**, and press OK to change advanced sound settings.

Personal Mode Sound Settings

Speaker virtualizer

🏠 (Home) > Settings > All settings > Sound > Personal mode settings > Speaker virtualizer

Select **On** or **Auto (Dolby Atmos)** to enable Dolby Atmos which can add height dimension in sound. With height dimension, sound can be precisely placed and moved in three-dimensional space.

Clear dialogue

🏠 (Home) > Settings > All settings > Sound > Personal mode settings > Clear dialogue

Select **On** to improve the sound for speech. Ideal for news programmes.

Equalizer

🏠 (Home) > Settings > All settings > Sound > Personal mode settings > Equalizer

Press the arrows **▲** (up) or **▼** (down) to adjust the equalizer settings.

* Note: To restore the **Personal mode** to its original setting, select back to **Sound style**, then press **■ Restore style**.

TV Placement

🏠 (Home) > Settings > All settings > Sound > TV placement

Select **On a TV stand** or **On the wall** to have best sound reproduction according to the setting.

Advanced sound settings

Volume Control

Auto volume

🏠 (Home) > Settings > All settings > Sound > Advanced > Auto volume

Select **On** to automatically level out sudden volume differences. Typically when you are switching channels. Select **Night mode** for a more comfortable quiet listening experience.

Delta volume

🏠 (Home) > Settings > All settings > Sound > Advanced > Delta volume

Press the arrows **▲** (up) or **▼** (down) to adjust the delta value for TV speaker volume.

* Note: Delta volume is available when the input source is set to HDMI or Analogue sources and the Audio out is set to **TV speakers** or **HDMI sound system**.

Audio Out Settings

🏠 (Home) > Settings > All settings > Sound > Advanced > Audio out

Set the TV to play the sound on TV or on the connected audio system.

You can select where you want to hear the TV sound and how you want to control it.

- If you select **TV Speakers off**, you permanently switch off the TV speakers.
- If you select **TV Speakers**, the TV speakers are always on. All the sound related settings are applicable to this mode.
- If you select **Headphones**, the sound will be played through headphones.
- If you select **TV Speakers + Headphones**, the sound will be played through TV speakers and headphones.

To adjust the volume of TV speakers or headphones, press **Volume** and press the arrows **▶** (right) or **◀** (left) to select the output source you want to adjust. Press the arrows **▲** (up) or **▼** (down) to adjust the volume.

With an audio device connected with HDMI CEC, select **HDMI sound system**. The TV will switch off the TV speakers when the device is playing the sound.

Digital Output Settings

Digital output settings are available for SPDIF output (optical) and HDMI ARC sound signals.

Digital out format

🏠 (Home) > Settings > All settings > Sound > Advanced > Digital out format

Set the audio out signal of the TV to fit the sound capabilities of the connected Home Theatre System.

- **Stereo (uncompressed):** If your audio playback devices have no multichannel sound processing, select to only output stereo content to your audio playback devices.
- **Multichannel:** Select to output multichannel audio content (compressed multichannel sound signal) or stereo audio content to your audio playback devices.
- **Multichannel (bypass):** Select to send original bitstream from HDMI ARC to the connected HDMI Sound System.

- Make sure your audio playback devices support Dolby Atmos feature.

- SPDIF output (DIGITAL AUDIO OUT) will be disabled when streaming Dolby Digital Plus content.

Digital out levelling

🏠 (Home) > Settings > All settings > Sound > Advanced > Digital out levelling

Adjust the loudness level from device which is connected to digital audio output (SPDIF) or HDMI.

- Select **More** to have louder volume.
- Select **Less** to have softer volume.

Digital out delay

🏠 (Home) > Settings > All settings > Sound > Advanced > Digital out delay

For some Home Theatre Systems you might need to adjust the audio sync delay to synchronise the audio to the video. Select **Off** if a sound delay is set on your Home Theatre System.

Digital out offset (Only available when Digital out delay set to On)

🏠 (Home) > Settings > All settings > Sound > Advanced > Digital out offset

- If you cannot set a delay on the Home Theatre System, you can set the TV to sync the sound.
- You can set an offset that compensates for the time necessary for the Home Theatre System to process the sound of the TV picture.

- You can set the value in steps of 5ms. Maximum setting is 60ms.

Channels

HbbTV Settings - Hybrid Broadcast Broadband TV

🏠 (Home) > Settings > All Settings > Channels > HbbTV settings > HbbTV

If a TV Channel offers HbbTV services, you must first switch on HbbTV in the TV settings to access to these advanced services, e.g. video on-demand and catch-up TV services.

🏠 (Home) > Settings > All Settings > Channels > HbbTV settings > HbbTV tracking

Switch the tracking of HbbTV browsing behaviour on or off. Switching off will inform the HbbTV services not to track your browsing behaviour.

🏠 (Home) > Settings > All Settings > Channels > HbbTV settings > HbbTV cookies

Switch the storage of third-party cookies, site data and cache from HbbTV services on or off.

🏠 (Home) > Settings > All Settings > Channels > HbbTV settings > Clear approved app listing

Allow you to clear the list of HbbTV applications that you have allowed to be launched on the TV.

General Settings

Connection Related Settings

Format USB Hard Drive

🏠 (Home) > Settings > All settings > General settings > Format USB Hard Drive

You need to set up and format a USB Hard Drive before you record a channel.

USB Keyboard Settings

🏠 (Home) > Settings > All settings > General settings > USB keyboard settings

To install the USB keyboard, switch on the TV and connect the USB keyboard to one of the USB connections on the TV. When the TV detects the keyboard for the first time, you can select your keyboard lay-out and test your selection.

Mouse Settings

🏠 (Home) > Settings > All settings > General settings > Mouse settings

Adjust the motion speed of the USB mouse.

HDMI-CEC Connection - EasyLink

Connect HDMI CEC-compatible devices to your TV, you can operate them with the TV remote control. EasyLink HDMI CEC must be switched on on the TV and the connected device.



Switch on EasyLink

🏠 (Home) > Settings > All settings > General settings > EasyLink > EasyLink > On

Operate HDMI CEC-compatible devices with TV remote control

🏠 (Home) > Settings > All settings > General settings > EasyLink > EasyLink remote control > On

Note:

- EasyLink might not work with devices from other brands.

- The HDMI CEC functionality has different names on different brands. Some examples are: Anynet, Aquos Link, Bravia Theatre Sync, Kuro Link, Simplink and Viera Link. Not all brands are fully compatible with EasyLink. Example HDMI CEC branding names are

property of their respective owners.

HDMI Ultra HD

🏠 (Home) > Settings > All settings > General settings > Input sources > HDMI (port) > HDMI Ultra HD

This TV can display Ultra HD signals. Some devices - connected with HDMI - do not recognise a TV with Ultra HD and might not work correctly or show distorted picture or sound.

To avoid the malfunctioning of such a device, you can adjust HDMI Ultra HD setting when TV is in the HDMI source. Recommended setting for legacy device is **Standard**.

- The setting **Optimal** allows maximum up to Ultra HD (50Hz or 60Hz) RGB 4:4:4 or YCbCr 4:4:4/4:2:2/4:2:0 signals.
- The setting **Standard** allows maximum up to Ultra HD (50Hz or 60Hz) YCbCr 4:2:0 signals.

Maximum supported video timing format for HDMI Ultra HD options:

- Resolution: 3840 x 2160
- Frame rate (Hz): 50Hz, 59.94Hz, 60Hz
- Video data sub-sampling (bit-depth)
 - 8 bit: YCbCr 4:2:0, YCbCr 4:2:2*, YCbCr 4:4:4*, RGB 4:4:4*
 - 10 bit: YCbCr 4:2:0*, YCbCr 4:2:2*
 - 12 bit: YCbCr 4:2:0*, YCbCr 4:2:2*

* Supported only when **HDMI Ultra HD** is set to **Optimal**.

Note: To watch HDR10+ or Dolby Vision content from HDMI source, you may need to power off your player and power on again when the player connected to TV playing such content for the first time. HDR10+ or Dolby Vision content is supported only when **HDMI Ultra HD** is set to **Optimal**.

Eco Settings

Set energy saving level

🏠 (Home) > Settings > All settings > General settings > Eco settings > Energy saving

Select **Minimum**, **Medium**, or **Maximum** to have different degrees for energy saving, or select **Off** to switch off energy saving mode.

Set screen off to save energy consumption

🏠 (Home) > Settings > All settings > General settings > Eco settings > Screen off

Select **Screen off**, the TV screen is switched off, to switch the TV screen back on, press any key on the remote control.

Set TV switch off timer

🏠 (Home) > Settings > All settings > General settings > Eco settings > Switch off timer

Press the arrows ▲ (up) or ▼ (down) to adjust the value. The value **0 (Off)** deactivates the automatic switch off.

Select **Switch off timer**, the TV switches off automatically to save energy.

- TV switches off if receiving a TV signal but you don't press a key on the remote control during a 4 hour period.
- TV switches off if not receiving a TV signal nor a remote control command for 10 minutes.
- If you use the TV as a monitor or use a digital receiver to watch TV (a Set-Top Box - STB) and you do not use the remote control of the TV, you should deactivate this automatic switch off, to set the value to **0**.

Location - Home or Shop

🏠 (Home) > Settings > All settings > General settings > Location

- Select the location of your TV
- Select **Shop**, the picture style is switched back to **Vivid**, and can adjust shop settings.
- Shop mode is for in-store promotion.

Shop Setup

🏠 (Home) > Settings > All settings > General settings > Shop setup

If the TV is set to **Shop**, you can view feature logos or set the availability of a specific demo for in store use.

Adjust Picture and audio

🏠 (Home) > Settings > All settings > General settings > Shop setup > Picture and audio

Select **Optimized to shop** or **Custom settings** for picture and audio settings.

Logos and banner

🏠 (Home) > Settings > All settings > General settings > Shop setup > Logos and banner

Set to display Feature logos and Promotional banner.

Demo Me autostart

🏠 (Home) > Settings > All settings > General settings > Shop setup > Demo Me autostart

Turn On/Off the Demo Me autostart.

Manage demos

🏠 (Home) > Apps > Demo me > Manage demos

If the TV is set to **Shop**, you can manage the demo videos in **Demo me** app.

Play demo video

🏠 (Home) > Apps > Demo me > Manage demos > Play

Select a demo video file and play.

Copy demo file

🏠 (Home) > Apps > Demo me > Manage demos > Copy to USB

Copy demo file to USB drive.

Delete demo file

🏠 (Home) > Apps > Demo me > Manage demos > Delete

Delete demo file from your TV.

Configuration of demo

🏠 (Home) > Apps > Demo me > Manage demos > Configuration

Set the TV to **Main TV** or **Sub TV**.

Download new demo file

🏠 (Home) > Apps > Demo me > Manage demos > Download new

If the Configuration is set to **Main TV**, you can download new demo file.

Auto delay setting

🏠 (Home) > Apps > Demo me > Manage demos > Auto delay setting

Set the Auto delay time from 15 seconds to 5 minutes.

Auto loop selection

🏠 (Home) > Apps > Demo me > Manage demos > Auto loop selection

Select a demo file for auto loop playing.

HDMI Auto game mode

🏠 (Home) > Settings > All settings > General settings > Input sources > HDMI (port) > HDMI Auto game mode

Set HDMI Auto game mode to On, if you want TV to automatically set Picture style to Game whenever it is informed by the HDMI device connected to TV. This feature is only selectable when HDMI Ultra HD set to Optimal.

Reset TV Settings and Reinstall TV

Reset all settings value to original TV settings

🏠 (Home) > Settings > All settings > General settings > Factory settings

Redo full TV installation, and set TV status back to the first time you switch on

🏠 (Home) > Settings > All settings > General settings > Reinstall TV

Enter PIN code and select Yes, the TV will reinstall completely. All settings will be reset and installed channels will be replaced. The installation can take a few minutes.

Region and Language Settings

Language

🏠 (Home) > Settings > All settings > Region and language > Language

Change the language of the TV menu and messages

🏠 (Home) > Settings > All settings > Region and language > Language > Menu language

Set audio preference language

🏠 (Home) > Settings > All settings > Region and language > Language > Primary audio, Secondary audio

Digital TV channels can broadcast audio with several spoken languages for a programme. You can set a preferred primary and secondary audio language. If audio in one of these languages is available, the TV will switch to this audio.

Set subtitle preference language

🏠 (Home) > Settings > All settings > Region and language > Language > Primary subtitle, Secondary subtitle

Digital channels can offer several subtitle languages for a programme. You can set a preferred primary and

secondary subtitle language. If subtitles in one of these languages are available, the TV will show the subtitles you selected.

Set teletext preference language

🏠 (Home) > Settings > All settings > Region and language > Language > Primary text, Secondary text

Some digital TV broadcasters have several Text languages available.

Clock

🏠 (Home) > Settings > All settings > Region and language > Clock

Correct clock automatically

🏠 (Home) > Settings > All settings > Region and language > Clock > Auto clock mode

- The standard setting for the TV clock is Automatic. The time information comes from the broadcasted UTC - Coordinated Universal Time information.
- If the clock is not correct, you can set the TV clock to Country dependent.
- When select Country dependent, you can set the time for Automatic or Standard time.

Correct clock manually

🏠 (Home) > Settings > All settings > Region and language > Clock > Auto clock mode > Manual

🏠 (Home) > Settings > All settings > Region and language > Clock > Date, Time

Go to previous menu, and select Date and Time to adjust the value.

Note:

- If none of the automatic settings display the time correctly, you can set the time manually.
- If you schedule recordings from the TV Guide, we recommend not to change the time and date manually.

Set time zone or set a time offset for your region

🏠 (Home) > Settings > All settings > Region and language > Clock > Time zone

Select one of the time zones.

Set the TV to switch to Standby automatically after a preset time

🏠 (Home) > Settings > All settings > Region and language > Clock > Sleep timer.

Set the TV to switch to Standby automatically after a preset time. With the slider bar you can set the time to up to 180 minutes in increments of 5 minutes. If set to 0 minutes, the sleep timer is switched off. You can always switch off your TV earlier or reset the time during the countdown

Postal Code

🏠 (Home) > Settings > All settings > Region and language > Postal code

The Early Warning System (EWS) is to warn the general public when the natural disasters are detected within the postal code area.

The TV will display the respective warning messages/alerts when triggered by the Broadcasters.

Note: This is for Indonesia only.

Universal Access Settings

🏠 (Home) > Settings > All settings > Universal access

With **Universal Access** switched on, the TV is prepared for use for the deaf, hard of hearing, blind or partially sighted people.

Switch on universal access settings

🏠 (Home) > Settings > All settings > Universal access > Universal access > On.

Universal access for hearing impaired people

🏠 (Home) > Settings > All settings > Universal access > Hearing impaired > On

- Some digital TV channels broadcast special audio and subtitles adapted for the hard of hearing or deaf people.
- Switched on, the TV automatically switches to the adapted audio and subtitles, if available.

Universal access for blind or partially sighted people

🏠 (Home) > Settings > All settings > Universal access > Audio description > Audio description > On

Digital TV channels can broadcast special audio commentary describing what is happening on screen.

🏠 (Home) > Settings > All settings > Universal access > Audio description > Audio description > Mixed volume, Audio effects, Speech

- Select **Mixed volume**, you can mix the volume of the normal audio with the audio commentary. Press the arrows **▲** (up) or **▼** (down) to adjust the value.
- Set **Audio effect** to **On** for extra audio effects in the commentary audio, like stereo or fading sound.
- Select **Speech** to set speech preference, **Descriptive** or **Subtitles**.

Dialogue enhancement

🏠 (Home) > Settings > All settings > Universal access > Dialogue enhancement

Increase the intelligibility of dialogue and commentary.

Lock Settings

Set Code and Change Code

🏠 (Home) > Settings > All settings > Child lock > Set code, Change code

Set new code or reset change code. The child lock code is used to lock or unlock channels or programmes.

Note: If you forgot your PIN code, you can override the current code use **8888** and enter a new code.

Lock for Programme

🏠 (Home) > Settings > All settings > Child lock > Parental rating

Set a minimum age to watch rated programmes.

App lock

🏠 (Home) > Settings > All settings > Child lock > App lock

You can lock apps unsuited for children. The App lock will ask for a PIN code when you try to start an 18+ rated app. This lock is only valid for 18+ rated apps from the Philips apps.

Wireless and Networks

12.1

Home Network

To enjoy the full capabilities of your Philips Smart TV, your TV must be connected to the Internet.

Connect the TV to a home network with a high-speed Internet connection. You can connect your TV wirelessly or wired to your network router.

12.2

Connect to Network

Wireless Connection

What You Need

To connect the TV to the Internet wirelessly, you need a Wi-Fi router with a connection to the Internet. Use a high-speed (broadband) connection to the Internet.



Turn Wi-Fi On or Off

🏠 (Home) > Settings > All settings > Wireless and networks > Wi-Fi On/Off

Make the Connection

Make the Connection - Wireless

🏠 (Home) > Settings > All settings > Wireless and networks > Connect to network > Wireless

1 - In the list of found networks, select on your wireless network. If your network is not in the list because the network name is hidden (you switched off the SSID broadcast of the router), select Add New Network to enter the network name yourself.

2 - Depending on the type of router, enter your encryption key - WEP, WPA or WPA2. If you entered the encryption key for this network before, you can

select **OK** to make the connection immediately.
3 - A message will be shown when the connection is successful.

Make the Connection - WPS

🏠 (Home) > Settings > All settings > Wireless and networks > Connect to network > WPS

If your router has WPS, you can directly connect to the router without scanning for networks. If you have devices in your wireless network that use the WEP security encryption system, you cannot use WPS.

1 - Go to the router, press the WPS button and return to the TV within 2 minutes.

2 - Select **Connect** to make the connection.

3 - A message will be shown when the connection is successful.

Make the Connection - WPS with PIN Code

🏠 (Home) > Settings > All settings > Wireless and networks > Connect to network > WPS with PIN Code

If your router has WPS with a PIN code, you can directly connect to the router without scanning for networks. If you have devices in your wireless network that use the WEP security encryption system, you cannot use WPS.

1 - Write down the 8-digit PIN code shown on screen and enter it in the router software on your PC. Consult the router manual on where to enter the PIN code in the router software.

2 - Select **Connect** to make the connection.

3 - A message will be shown when the connection is successful.

Wired Connection

What You Need

To connect the TV to the Internet, you need a network router with a connection to the Internet. Use a high-speed (broadband) connection to the Internet.

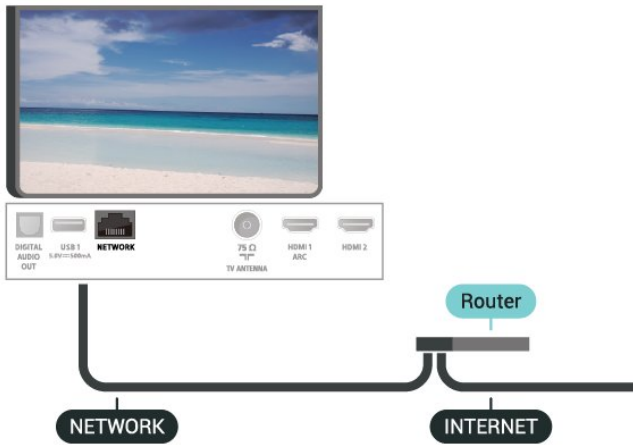

Make the Connection

🏠 (Home) > Settings > All settings > Wireless and networks > Connect to network > Wired

- 1 - Connect the router to the TV with a network cable (Ethernet cable**).
- 2 - Make sure that the router is switched on.
- 3 - The TV constantly searches for the network connection.
- 4 - A message will be shown when the connection is successful.

If the connection fails, you can check the DHCP setting of the router. DHCP should be switched on.

**To fulfill EMC regulations, use a shielded FTP Cat. 5E Ethernet cable.

12.3

Wireless and Network Settings

View Network Settings

🏠 (Home) > Settings > All settings > Wireless and networks > View network settings

You can view all current network settings here. The IP and MAC address, signal strength, speed, encryption method, etc.

Network Configuration - Static IP

🏠 (Home) > Settings > All settings > Wireless and networks > Network Configuration > Static IP

If you are an advanced user and want to install your network with Static IP addressing, set the TV to **Static IP**.

Network Configuration - Static IP Configuration

🏠 (Home) > Settings > All settings > Wireless and networks > Static IP configuration

1 - Select **Static IP configuration** and configure the connection.

2 - You can set the number for **IP Address**, **Netmask**, **Gateway**, **DNS 1**, or **DNS 2**.

Switch On with Wi-Fi (WoWLAN)

🏠 (Home) > Settings > All settings > Wireless and networks > Switch On with Wi-Fi (WoWLAN)

You can switch this TV on from your smartphone or tablet if the TV is in Standby. The setting **Switch On with Wi-Fi (WoWLAN)** must be switched on.

Digital Media Renderer - DMR

🏠 (Home) > Settings > All settings > Wireless and networks > Digital Media Renderer - DMR

If your media files do not play on your TV, make sure that the Digital Media Renderer is switched on. As a factory setting, DMR is switched on.

Switch on Wi-Fi connection

🏠 (Home) > Settings > All settings > Wireless and networks > Wi-Fi On/Off

You can switch on or off Wi-Fi connection on your TV.

Reset Wi-Fi Miracast connection

🏠 (Home) > Settings > All settings > Wireless and networks > Reset Wi-Fi Miracast connection

Clear the list of connected and blocked devices that are used with Miracast.

TV network name

🏠 (Home) > Settings > All settings > Wireless and networks > TV network name

If you have more than one TV in your home network, you can give the TV a unique name.

Netflix settings

🏠 (Home) > Settings > All settings > Wireless and networks > Netflix settings

With **Netflix settings**, you can view ESN number or deactivate Netflix device.

Clear Internet Memory

🏠 (Home) > Settings > All settings > Wireless and networks > Clear Internet Memory

With Clear Internet Memory you clear your Philips server registration and parental rating settings, your video store app logins, all Philips App Gallery favourites, Internet bookmarks and history. Interactive MHEG applications can also save so-called 'cookies', on your TV. These files will also be cleared.

Smart TV

Setup Smart TV

The first time you open Smart TV, you need to configure your connection. Read and agree to the terms and conditions to continue.

The Smart TV start page is your link to the Internet. You can rent movies online, read newspapers, watch videos and listen to music, also shop online, or watch TV programmes when it suits you with On-line TV.

Open Smart TV

To open the Smart TV start page, press **Smart TV**. Alternatively, you can press **Home** > **Apps**, select **Smart TV** and press **OK**.

The TV connects to the Internet and opens the Smart TV start page. This may take a few seconds.

Close Smart TV

To close the Smart TV start page, press **EXIT**.

TP Vision Europe B.V. bears no responsibility regarding the content and the quality of the content provided by the content service providers.

Smart TV Start Page

Your Apps

You start Apps from the **Smart TV** start page.

Internet

The Internet App opens the World Wide Web on your TV.

On your TV, you can view any Internet website but most of them are not tailored for a TV screen.

- Some plug-ins (e.g. to view pages or videos) are not available on your TV.

- Internet pages are shown one page at a time and full screen.

App Gallery

Open the **App Gallery** in **Smart TV** to browse the Apps, the collection of tailored websites for TV.

Find the App for YouTube videos, a national newspaper, an online photo album, etc. There are Apps to rent a video from an online video store and Apps for watching programmes you missed. If the

App gallery does not hold what you are looking for, try the World Wide Web and surf the Internet on TV.

Search

With Search, you can search the **App Gallery** for relevant Apps.

Enter a keyword in the text field, select **Search** and press **OK** to start searching. You can enter names, titles, genres and description keywords to search. Alternatively, you can leave the text field empty and search for the most popular searches/keywords for a range of categories. In the list of found keywords, select a keyword and press **OK** to search for items with that keyword.

Video on Demand

Video on Demand

🏠 (Home) > Apps > Video on Demand

You can rent movies from an online rental video store.

Netflix

If you have a Netflix membership subscription, you can enjoy Netflix on this TV. Your TV must be connected to the Internet.

To open Netflix, press **NETFLIX** to open the Netflix App. You can open Netflix immediately from a TV in standby.

www.netflix.com

Amazon Prime Video

With an Amazon prime membership, you gain access to thousands of popular movies and TV show, including exclusive Prime Originals.

Press the app icon to open the Amazon Prime Video app. Your TV must be connected to the Internet to use the app. For more information about Amazon Prime Video, please visit www.primevideo.com.

YouTube

YouTube provides a platform to connect to the world. Watch and discover popular videos that uploaded by YouTube users around the world. Use the YouTube app to explore the latest topics on music, news, and more.

Press the app icon to open the YouTube app. Your TV must be connected to the Internet to use the app. For more information about YouTube, please visit www.youtube.com.

Environmental

18.1

End of Use

Disposal of your old product and batteries

Your product is designed and manufactured with high quality materials and components, which can be recycled and reused.



When this crossed-out wheeled bin symbol is attached to a product it means that the product is covered by the European Directive 2012/19/EU.



Please inform yourself about the local separate collection system for electrical and electronic products.

Please act according to your local rules and do not dispose of your old products with your normal household waste. Correct disposal of your old product helps to prevent potential negative consequences for the environment and human health.

Your product contains batteries covered by the European Directive 2006/66/EC, which cannot be disposed with normal household waste.



Please find out for yourself about the local rules on separate collection of batteries because correct disposal will help to prevent negative consequences for the environment and human health.

Specifications

19.1

Power

Product specifications are subject to change without notice. For more specification details of this product, see www.philips.com/TVsupport

Power

- Mains power : AC 110–240V +/-10%
- Ambient temperature : 5°C to 35°C

19.2

Reception

- Aerial input : 75 ohm coaxial (IEC75)
- Tuner bands : Hyperband, UHF, VHF
- DVB : DVB-T2
- Analogue video playback : SECAM, PAL
- Digital video playback : MPEG2 SD/HD (ISO/IEC 13818-2), MPEG4 SD/HD (ISO/IEC 14496-10)
- Digital audio playback (ISO/IEC 13818-3)

19.3

Display Resolution

Diagonal screen size

- 50PUT6604 : 126 cm / 50 inch
- 58PUT6604 : 146 cm / 58 inch

Display resolution

- 3840 x 2160

19.4

Supported Input Resolution - Video

Support Timing

Video support timing also includes field/frame rate 23.976Hz, 29.97Hz and 59.94Hz.

HDMI

- 480i
- 480p
- 576i
- 576p
- 720p
- 1080i

- 1080p
- 3840 x 2160p - 24Hz, 25Hz, 30Hz, 50Hz, 60Hz

HDMI - UHD

🏠 (Home) > Settings > General settings > Input sources > HDMI (port) > HDMI Ultra HD

This TV can display Ultra HD signals. Some devices - connected with HDMI - do not recognise a TV with Ultra HD and might not work correctly or show distorted picture or sound.

To avoid the malfunctioning of such a device, you can set the signal quality to a level the device can handle. If the device is not using Ultra HD signals, you can switch off Ultra HD for this HDMI connection.

- The setting **Optimal** allows maximum up to Ultra HD (50Hz or 60Hz) RGB 4:4:4 or YCbCr 4:4:4/4:2:2/4:2:0 signals.
- The setting **Standard** allows maximum up to Ultra HD (50Hz or 60Hz) YCbCr 4:2:0 signals.

Composite

Composite

- PAL, NTSC, SECAM

19.5

Supported Input Resolution - Computer

- 640 x 480 - 60Hz
- 800 x 600 - 60Hz
- 1024 x 768 - 60Hz
- 1280 x 800 - 60Hz
- 1280 x 960 - 60Hz
- 1280 x 1024 - 60Hz
- 1366 x 768 - 60Hz
- 1440 x 900 - 60Hz
- 1920 x 1080 - 60Hz
- 3840 x 2160 - 60Hz

Note: For HDMI Input only

19.6

Sound

- Dolby Atmos® Virtualizer
- Clear Dialogue
- A.I Sound
- 5 Band Equalizer
- Output power (RMS) : 20W
- Dolby® Audio

19.7

Multimedia

Connections

- USB 2.0 / USB 3.0
- Ethernet LAN RJ-45
- Wi-Fi 802.11n (built-in)

Supported USB file systems

- FAT, NTFS

Playback formats

- Video Codec : AVI, MKV, H.264/MPEG-4 AVC, MPEG1, MPEG2, MPEG4, WMV9/VC1, VP9, HEVC (H.265)
- Audio Codec : MP3, WAV, AAC, WMA (v2 up to v9.2), WMA-PRO (v9 and v10)
- Subtitles :
 - Format: SRT, SMI, SSA, SUB, ASS, TXT
 - Character encodings : UTF-8, Central Europe and Eastern Europe (Windows-1250), Cyrillic (Windows-1251), Greek (Windows-1253), Turkish (Windows-1254), Western Europe (Windows-1252)
- Maximum Supported Data Rate :
 - MPEG-4 AVC (H.264) is supported up to High Profile @ L5.1. 30Mbps
 - H.265 (HEVC) is supported up to Main / Main 10 Profile up to Level 5.1 40Mbps
 - VC-1 is supported up to Advanced Profile @ L3
- Image Codec : JPEG, GIF, PNG, BMP, HEIF, 360 photo

Wi-Fi Certified

This TV supports Miracast certified devices.

Performance may vary, depending on the capabilities of the mobile device and the software used.

19.8

Connectivity

TV Side

- CVBS: CVBS, Audio L/R
- USB 2: USB 3.0
- HDMI 3 in: UHD - HDR
- Headphones: Stereo mini-jack 3.5mm

TV Bottom

- Digital Audio out: Optical
- USB 1: USB 2.0
- Network LAN: RJ45
- Antenna (75 ohm)
- HDMI 1 in: ARC - UHD - HDR
- HDMI 2 in: UHD - HDR

Troubleshooting

20.1

Tips

If you can't find a solution for your TV problem in **Troubleshooting**, you can use **— Keywords** in **Help > User manual** to find the information you are looking for. Select a keyword to go the most relevant page in the User manual.

If the User manual doesn't answer your question, you can go to the support website of Philips.

To solve any Philips TV related problem, you can consult our online support. You can select your language and enter your product model number.

Go to www.philips.com/TVsupport.

On the support site you can find your country's telephone number to contact us as well as answers to frequently asked questions (FAQs). In some countries, you can chat with one of our collaborators and ask your question directly or send a question by email. You can download new TV software or the manual to read on your computer.

For more TV troubleshooting and frequently asked questions (FAQs)...

Go to <http://philips-tvconsumercare.kxondemand.com/portal/en/ModelSelect>

TV Help on your tablet, smartphone or computer

To carry out extended sequences of instructions more easily, you can download the TV Help in PDF format to read on your smartphone, tablet or computer. Alternatively, you can print the relevant Help page from your computer.

To download the Help (user manual) go to www.philips.com/TVsupport

20.2

Switch On

The TV does not switch on

- Disconnect the power cable from the power outlet. Wait for one minute then reconnect it. Make sure that the power cable is securely connected. Try switching on again.
- Connect the TV to another wall mains socket and try switching on.
- Disconnect all connected devices from the TV and try switching on.
- If the standby light on TV is on, the TV might not

respond to the remote control.

Creaking sound at startup or switch off

When you are turning the TV on or standby, you hear a creaking sound from the TV chassis. The creaking sound is due to the normal expansion and contraction of the TV as it cools and warms up. This does not affect performance.

The TV goes back to standby after showing the Philips startup screen

When the TV is in standby, a Philips startup screen is displayed, then the TV returns to standby mode. This is normal behaviour. When the TV is disconnected and reconnected to the power supply, the startup screen is displayed at the next startup. To switch on the TV from standby, press **⏻** (Standby / On) the remote control or the TV.

The standby light keeps on blinking

Disconnect the power cable from the power outlet. Wait 5 minutes before you reconnect the power cable. If the blinking reoccurs, contact Philips TV Consumer Care.

In **Help > User manual**, press the colour key **— Keywords** and look up **Contact Info**.

TV switches off by itself

If the TV switches off suddenly, the setting **Switch off timer** might be switched on. With **Switch off timer** the TV switches off after 4 hours if no remote control signals were received. To avoid this automatic switch off, you can deactivate this switch off.

In **Help > User manual**, press the colour key **— Keywords** and look up **Switch Off Timer**. Also, if the TV does not receive a TV signal nor a remote control command for 10 minutes, the TV switches off automatically.

20.3

Remote Control

TV does not respond to the remote control

- The TV requires some time to start up. During this time, the TV does not respond to the remote control or TV controls. This is normal behaviour.
- The batteries of the remote control might be empty. Replace the batteries with new ones.

20.4

Channels

No digital channels found during the installation

- Check if the TV was connected with an antenna or is using a provider signal. Check the cable connections.
- Check if the country where you install the TV, has

digital channels available.

- Check if you selected the correct DVB (Digital Video Broadcast) system.
- Redo the installation and check if you select the correct country.

No analogue channels found during the installation

- Check if the TV was connected with an antenna. Check the cable connections.
- Check if you selected the correct DVB (Digital Video Broadcast) system. Select DVB-T (terrestrial) when you use an antenna or common antenna.
- Redo the installation and select **Digital and analogue channels** during the installation.

Some channels disappeared, cannot find all or some previously installed channels

- Check if you selected the correct **Channel list** or **Favourites list** you normally use.
- Some channels might be moved or even deleted by the broadcaster. In the normal channels list, try to search for the channel you're missing. If the channel is still available, you can put it back in the favourites list.
- A channel can be deleted from the channel list during **Automatic channel update**. These automatic updates are done overnight if the TV is on standby.

Channels that do not exist anymore are deleted and new channels will be added to the channel list. Exceptionally, a channel can be deleted because the TV could not find it while checking for its presence. It might not broadcast at night.

To avoid channels being deleted during the **Automatic channel update** because the TV could not find them although these channels are still there, you can switch off **Automatic channel update**.

⬆️ (Home) > Settings > All Settings > Channels > Antenna installation > Automatic channel update

DVB-T2 HEVC channel

- See the technical specifications to make sure that your TV supports DVB-T2 HEVC in your country and reinstall DVB-T channel.

20.5

Picture

No picture / distorted picture

- Check if the TV is connected with an antenna or is using a provider signal. Check the cable connections.
 - Check if the correct source/input is selected in the sources menu. Press **Sources** and select the source/input you need.
 - Check if the the external device or source is properly connected.
 - Check if the reception is poor.
 - Check if the picture is set to a minimal value. Select **Picture style** and select a style and press **OK**.
- ⬆️ (Home) > Settings > All

settings > Picture > Picture style

- To check if the TV is broken, try to play a video clip. Press **⬆️ (Home) > Settings > Help > Check the TV**. If the video clip stays black, call Philips. Wait until the clip ends and select **Contact info** in the Help menu. Call the telephone number for your country.

Sound but no picture

- Change to other video sources and then change back to current source.
 - Select **Picture style** and select a style and press **OK**.
- ⬆️ (Home) > Settings > All settings > Picture > Picture style
- Restore picture style, select back to **Picture style**, then press **— Restore style**.
 - Reset all TV settings, go to **⬆️ (Home) > Settings > All settings > General settings > Reinstall TV**.
 - Check the connections of the source/input devices.

Poor reception

If the TV picture is distorted or variable in quality, the input signal might be poor. A weak digital signal is seen as a picture that is breaking up in square blocks and freezes occasionally. Much sooner than a bad analogue signal, a bad digital signal will fall away.

- Check if the antenna cable is properly connected.
- Large loudspeakers, unearthed audio devices, neon lights, high buildings and other large objects can influence reception quality when you are using an antenna. Try to improve the reception by changing the antenna direction or moving devices away from the TV. Bad weather might deteriorate the reception.
- Check if all connections, to and from your devices, are properly connected.
- If reception on only one channel is poor, fine-tune this channel with **Analogue: manual installation**. (Only for analogue channels)

⬆️ (Home) > Settings > Install

Channels > Antenna/cable

installlation > Analogue: manual installation

- Check if the incoming digital signal is sufficiently strong. While watching a digital channel, press **≡ OPTIONS** and select **Status** and press **OK**. Check the **Signal strenght** and **Signal quality**.

Poor picture from a device

- Make sure that the device is connected properly. Make sure that the device's output video setting is the highest possible resolution if applicable.
- Restore picture style or change to another picture style.

Picture settings change after a while

Make sure that **Location** is set to **Home**. You can change and save settings in this mode.

⬆️ (Home) > Settings > All settings > General settings > Location

A banner appears

If an on screen promotion banner appears occasionally or the Picture style automatically switches back to Vivid at startup, the TV is in Shop location. Set the TV to Home location for use at home.

▲ (Home) > Settings > All settings > General settings > Location

Picture does not fit the screen / Wrong or unstable picture size / Picture position is incorrect

- If the picture size - its aspect ratio - does not fit the screen, with black bars on the top and bottom or left and right side of the screen, press ▲ (Home) > Settings > All settings > Picture > Picture Format > Fill screen.

- If the picture size changes all the time, press ▲ (Home) > Settings > All settings > Picture > Picture Format > Fit to screen.

- If the position of the picture is incorrect on the screen, try to check the signal resolution and output type of the connected device, press ▲ (Home) > Settings > All settings > Picture > Picture Format > Original.

Computer picture is not stable

Make sure that your PC uses the supported resolution and refresh rate.

▲ (Home) > Settings > All settings > Picture >

20.6

Sound

No sound or poor sound quality

- Check if the sound settings of the TV are OK, press the 🔊 volume or 🔇 mute key.

- If you use a digital receiver (set-top box), check if the volume on this receiver is not set to zero or mute.

- Check if the TV - the audio signal - is properly connected with the Home Theatre System, if you use such a system for the TV sound. Check if you connected the HDMI cable to an HDMI1 ARC connection on the Home Theatre System.

- Make sure that the TV audio output is connected to the audio input on the Home Theatre System.

Sound should be heard from the HTS (Home Theatre System) speakers.

Sound with loud noise

If you watch a video from a plugged in USB flash drive or connected computer, the sound from your Home Theatre System might be distorted. This noise is heard when the audio or video file has DTS sound but the Home Theatre System has no DTS sound processing. You can fix this by setting the Digital out format of the TV to Stereo.

Press ▲ (Home) > Settings > All settings > Sound > Advanced > Digital out format

20.7

HDMI - UHD

HDMI

- Note that HDCP (High-bandwidth Digital Content Protection) support can delay the time taken for a TV to display content from an HDMI device.

- If the TV does not recognise the HDMI device and no picture is displayed, switch the source from one device to another and back again.

- This is an Ultra HD TV. Some older devices - connected with HDMI - do not recognise an Ultra HD TV electronically and might not work correctly or show distorted picture or sound. To avoid the malfunctioning of such a device, you can set the signal quality to a level the device can handle. If the device is not using Ultra HD signals, you can switch off Ultra HD for this HDMI connection.

If the picture and sound of a device connected with HDMI is distorted, check if a different HDMI Ultra HD setting can solve this problem. In Help > User manual, press the colour key ■ Keywords and look up HDMI Ultra HD.

- If there are intermittent sound disruptions, make sure that output settings from the HDMI device are correct.

HDMI EasyLink does not work

- Check if your HDMI devices are HDMI-CEC compatible. EasyLink features only work with devices that are HDMI-CEC compatible.

No volume icon shown

- When an HDMI-CEC audio device is connected and you use the TV Remote Control to adjust the volume level from the device, this behaviour is normal.

20.8

USB

Photos, videos and music from a USB device do not show

- Check if the USB storage device is set to Mass Storage Class compliant, as described in the storage device's documentation.

- Check if the USB storage device is compatible with the TV.

- Check if the audio and picture file formats are supported by the TV. For more information, in Help, press the colour key ■ Keywords and look up Multimedia.

Choppy playback of USB files

- The transfer performance of the USB storage device may limit the data transfer rate to the TV which causes poor playback.

Wi-Fi and Internet

Wi-Fi network not found or distorted

- Check if the firewalls in your network allow access to the TV's wireless connection.
- If the wireless network does not work properly in your home, try the wired network installation.

Internet does not work

- If the connection to the router is OK, check the router connection to the Internet.

The PC and Internet connection are slow

- Look in your wireless router's user manual for information on indoor range, transfer rate and other factors of signal quality.
- Use a high-speed (broadband) Internet connection for your router.

DHCP

- If the connection fails, you can check the DHCP (Dynamic Host Configuration Protocol) setting of the router. DHCP should be switched on.

Wrong Menu Language

Change the language back to your language.

1 - Press **↑** (Home), select **Settings > Region and language > Languages > Menu language** and press **OK**.

2 - Select on the language you need and press **OK**.

3 - Press **←** **BACK** to close the menu.

Safety and Care

21.1

Safety

Important

Read and understand all safety instructions before you use the TV. If damage is caused by failure to follow instructions, the warranty does not apply.

Risk of Electric Shock or Fire

- Never expose the TV to rain or water. Never place liquid containers, such as vases, near the TV. If liquids are spilt on or into the TV, disconnect the TV from the power outlet immediately. Contact Philips TV Consumer Care to have the TV checked before use.
- Never expose the TV, remote control or batteries to excessive heat. Never place them near burning candles, naked flames or other heat sources, including direct sunlight.
- Never insert objects into the ventilation slots or other openings on the TV.
- Never place heavy objects on the power cord.
- Avoid force coming onto power plugs. Loose power plugs can cause arcing or fire. Ensure that no strain is exerted on the power cord when you swivel the TV screen.
- To disconnect the TV from the mains power, the power plug of the TV must be disconnected. When disconnecting the power, always pull the power plug, never the cord. Ensure that you have full access to the power plug, power cord and outlet socket at all times.

Risk of Injury or Damage to the TV

- Two people are required to lift and carry a TV that weighs more than 25 kg or 55 lbs.
- If you mount the TV on a stand, only use the supplied stand. Secure the stand to the TV tightly. Place the TV on a flat, level surface that can support the weight of the TV and the stand.
- When wall mounted, ensure that the wall mount can safely bear the weight of the TV set. TP Vision bears no responsibility for improper wall mounting that results in accident, injury or damage.
- Parts of this product are made of glass. Handle with care to avoid injury or damage.

Risk of damage to the TV !

Before you connect the TV to the power outlet,

ensure that the power voltage matches the value printed on the back of the TV. Never connect the TV to the power outlet if the voltage is different.

Risk of Injury to Children

Follow these precautions to prevent the TV from toppling over and causing injury to children:

- Never place the TV on a surface covered by a cloth or other material that can be pulled away.
- Ensure that no part of the TV hangs over the edge of the mounting surface.
- Never place the TV on tall furniture, such as a bookcase, without anchoring both the furniture and TV to the wall or a suitable support.
- Teach children about the dangers of climbing on furniture to reach the TV.

Risk of swallowing batteries !

The remote control may contain coin-type batteries which can easily be swallowed by small children. Keep these batteries out of reach of children at all times.

Risk of Overheating

Never install the TV in a confined space. Always leave a space of at least 10 cm or 4 inches around the TV for ventilation. Ensure curtains or other objects never cover the ventilation slots on the TV.

Lightning Storms

Disconnect the TV from the power outlet and antenna before lightning storms. During lightning storms, never touch any part of the TV, power cord or antenna cable.

Risk of Hearing Damage

Avoid using earphones or headphones at high volumes or for prolonged periods of time.

Low Temperatures

If the TV is transported in temperatures below 5°C or 41°F, unpack the TV and wait until the TV temperature reaches room temperature before connecting the TV to the power outlet.

Humidity

In rare occasions, depending on temperature and humidity, minor condensation can occur on the inside of the TV glass front (on some models). To prevent this, do not expose the TV to direct sunlight, heat or extreme humidity. If condensation occurs, it will disappear spontaneously while the TV is playing for a few hours.

The condensation moisture will not harm the TV or cause malfunction.

21.2

Screen Care

Clean

- Never touch, push, rub or strike the screen with any object.
- Unplug the TV before cleaning.
- Clean the TV and frame with a soft damp cloth and wipe gently. Never use substances such as alcohol, chemicals or household cleaners on the TV.
- To avoid deformations and colour fading, wipe off water drops as quickly as possible.
- Avoid stationary images as much as possible.

Stationary images are images that remain onscreen for extended periods of time. Stationary images include onscreen menus, black bars, time displays, etc. If you must use stationary images, reduce screen contrast and brightness to avoid screen damage.

Terms of Use

2019 © TP Vision Europe B.V. All rights reserved.

This product was brought to the market by TP Vision Europe B.V. or one of its affiliates, hereinafter referred to as TP Vision, which is the manufacturer of the product. TP Vision is the warrantor in relation to the TV with which this booklet was packaged. Philips and the Philips Shield Emblem are registered trademarks of Koninklijke Philips N.V.

Specifications are subject to change without notice. Trademarks are the property of Koninklijke Philips N.V or their respective owners. TP Vision reserves the right to change products at any time without being obliged to adjust earlier supplies accordingly.

The written material packaged with the TV and the manual stored in the memory of the TV or downloaded from the Philips website www.philips.com/TVsupport are believed to be adequate for the intended use of the system.

The material in this manual is believed adequate for the intended use of the system. If the product, or its individual modules or procedures, are used for purposes other than those specified herein, confirmation of their validity and suitability must be obtained. TP Vision warrants that the material itself does not infringe any United States patents. No further warranty is expressed or implied. TP Vision cannot be held responsible neither for any errors in the content of this document nor for any problems as a result of the content in this document. Errors reported to Philips will be adapted and published on the Philips support website as soon as possible.

Terms of warranty - Risk of injury, damage to TV or void of warranty!

Never attempt to repair the TV yourself. Use the TV and accessories only as intended by the manufacturer. The caution sign printed on the back of the TV indicates risk of electric shock. Never remove the TV cover. Always contact Philips TV Customer Care for service or repairs. Find the telephone number in the printed documentation that came with the TV. Or consult our website www.philips.com/TVsupport and select your country if needed. Any operation expressly prohibited in this manual, or any adjustments and assembly procedures not recommended or authorised in this manual, shall void the warranty.

Pixel characteristics

This TV product has a high number of colour pixels. Although it has effective pixels of 99.999% or more, black dots or bright points of light (red, green or blue) may appear constantly on the screen. This is a structural property of the display (within common industry standards) and is not a malfunction.

TP Vision is committed to developing, producing and marketing products that cause no adverse health effects. TP Vision confirms that, as long as its products are handled properly for their intended use, they are safe to use according to scientific evidence available today. TP Vision plays an active role in the development of safety standards, enabling TP Vision to anticipate further developments in standardisation for early integration in its products.

Copyrights

23.1

HDMI

The terms HDMI and HDMI High-Definition Multimedia Interface, and the HDMI Logo are trademarks or registered trademarks of HDMI Licensing Administrator, Inc. in the United States and other countries.



23.2

Dolby Audio

Dolby Audio

Dolby, Dolby Audio, and the double-D symbol are trademarks of Dolby Laboratories. Manufactured under license from Dolby Laboratories. Confidential unpublished works. Copyright © 1992–2015 Dolby Laboratories. All rights reserved.



23.3

Dolby Vision and Dolby Atmos

Dolby Vision and Dolby Atmos

Dolby, Dolby Atmos, Dolby Audio, Dolby Vision, and the double-D symbol are trademarks of Dolby Laboratories. Manufactured under license from Dolby Laboratories. Confidential unpublished works. Copyright © 1992–2018 Dolby Laboratories. All rights reserved.



DTS-HD (italics)

DTS-*HD*® offers decoding of DTS content for up to 5.1 discrete channels with support for low bit rate and streaming media. It supports transcoding of content via digital output such as HDMI for playback on legacy products.



23.5

Wi-Fi Alliance

Wi-Fi®, the Wi-Fi CERTIFIED logo, the Wi-Fi logo are registered trademarks of the Wi-Fi Alliance.



23.6

Other Trademarks

All other registered and unregistered trademarks are the property of their respective owners.

Open Source

24.1

Open Source Software

This television contains open source software. TP Vision Europe B.V. hereby offers to deliver, upon request, a copy of the complete corresponding source code for the copyrighted open source software packages used in this product for which such offer is requested by the respective licences.

This offer is valid up to three years after product purchase to anyone in receipt of this information. To obtain the source code, please write in English to .

open.source@tpv-tech.com

24.2

Open Source License

About Open Source License

README for the source code of the parts of TP Vision Netherlands B.V. TV software that fall under open source licenses.

This is a document describing the distribution of the source code used on the TP Vision Netherlands B.V. TV, which fall either under the GNU General Public License (the GPL), or the GNU Lesser General Public License (the LGPL), or any other open source license. Instructions to obtain copies of this software can be found in the Directions For Use.

TP Vision Netherlands B.V. MAKES NO WARRANTIES WHATSOEVER, EITHER EXPRESS OR IMPLIED, INCLUDING ANY WARRANTIES OF MERCHANTABILITY OR FITNESS FOR A PARTICULAR PURPOSE, REGARDING THIS SOFTWARE. TP Vision Netherlands B.V. offers no support for this software. The preceding does not affect your warranties and statutory rights regarding any TP Vision Netherlands B.V. product(s) you purchased. It only applies to this source code made available to you.

Open Source

bash (3.2.48)

Bash is the shell, or command language interpreter, that will appear in the GNU operating system.

Bash is an sh-compatible shell that incorporates useful features from the Korn shell (ksh) and C shell (csh).

It is intended to conform to the IEEE POSIX

P1003.2/ISO 9945.2 Shell and Tools standard. It offers functional improvements over sh for both programming and interactive use.

In addition, most sh scripts can be run by Bash without modification.

Source: <http://www.gnu.org/software/bash/>

c-ares (1.10.0)

c-ares is a C library that performs DNS requests and name resolves asynchronously.

Source: <http://c-ares.haxx.se/>

coreutils (6.9)

The GNU Core Utilities are the basic file, shell and text manipulation utilities of the GNU operating system.

These are the core utilities which are expected to exist on every operating system.

Source: <http://www.gnu.org/software/coreutils/>

e2fsprogs (2.12.2)

e2fsprogs provides the filesystem utilities for use with the ext2 filesystem, it also supports the ext3 and ext4 filesystems.

This piece of software is made available under the terms and conditions of the e2fsprogs license, which can be found below.

Source: <http://e2fsprogs.sourceforge.net/>

Expat (2.01)

xml parser; Expat is an XML parser library written in C. It is a stream-oriented parser in which an application registers handlers for things the parser might find in the XML document (like start tags). An introductory article on using.

This piece of software is made available under the terms and conditions of the Expat license, which can be found below.

Source: <http://expat.sourceforge.net/>

DFB (4.2.31)

It is a software library for GNU/Linux/UNIX based operating system with a small memory footprint that provides graphics acceleration, input device handling and abstraction layer, and integrated windowing system with support for translucent windows and multiple display layers on top of the Linux framebuffer without requiring any kernel modifications

Source: http://sourceforge.net/projects/jointspace/files/remote_applications_SDK/remote_spplications_SDK_v1.3.1/DirectFB141_source_1.3.1.7z/download

SAWMAN

SaWMan, the Shared application and Window Manager, is a new window manager module for use with DirectFB.

Source: <http://www.directfb.org/index.php?path=Main%2FDownloads&page=1>

findutils (4.2.31)

The GNU Find Utilities are the basic directory searching utilities of the GNU operating system. These programs are typically used in conjunction with other programs to provide modular and powerful directory search and file locating capabilities to other commands.
Source: <http://www.gnu.org/software/findutils/>

Freetype (2.4.3)
FreeType is a software font engine that is designed to be small, efficient, highly customizable, and portable while capable of producing high-quality output (glyph images).
Source: <http://freetype.sourceforge.net>

fuse (2.8.4)
Fuse is a simple interface for userspace programs to export a virtual filesystem to the linux kernel. This piece of software is made available under the terms and conditions of the fuse license, which can be found below.
Source: <http://fuse.sourceforge.net/>

gawk (3.1.5)
If you are like many computer users, you would frequently like to make changes in various text files wherever certain patterns appear, or extract data from parts of certain lines while discarding the rest. To write a program to do this in a language such as C or Pascal is a time-consuming inconvenience that may take many lines of code. The job is easy with awk, especially the GNU implementation: gawk.
Source: <http://www.gnu.org/software/gawk/>

glibc (2.12.2)
Any Unix-like operating system needs a C library: the library which defines the "system calls" and other basic facilities such as open, malloc, printf, exit...The GNU C library is used as the C library in the GNU system and most systems with the Linux kernel. This piece of software is made available under the terms and conditions of the glibc license, which can be found below.
Source: <http://www.gnu.org/software/libc/>

grep (2.5.1a)
The grep command searches one or more input files for lines containing a match to a specified pattern. By default, grep prints the matching lines.
Source: <http://www.gnu.org/software/grep/>

gzip (1.3.12)
GNU Gzip is a popular data compression program originally written by Jean-loup Gailly for the GNU project. Mark Adler wrote the decompression part.
Source: <http://www.gnu.org/software/gzip/>

inetutils (1.4.2)
Inetutils is a collection of common network programs.

Source: <http://www.gnu.org/software/inetutils/>
iptables (1.4.15)
For Cross connection.
Source: <http://www.netfilter.org/projects/iptables/>

iputils (s20101006)
The iputils package is set of small useful utilities for Linux networking. It was originally maintained by Alexey Kuznetsov.
Source: <http://www.skbuff.net/iputils/>

Libcurl (7.30.0)
HTTP client; libcurl is a free and easy-to-use client-side URL transfer library, supporting FTP, FTPS, HTTP, HTTPS, SCP, SFTP, TFTP, TELNET, DICT, LDAP, LDAPS, FILE, IMAP, SMTP, POP3 and RTSP. libcurl supports SSL certificates, HTTP POST, HTTP PUT, FTP uploading, HTTP form based upload, proxies, cookies, user+password authentication (Basic, Digest, NTLM, Negotiate, Kerberos4), file transfer resume, http proxy tunneling and more!
This piece of software is made available under the terms and conditions of the Libcurl license, which can be found below.
Source: <http://curl.haxx.se/>

libiconv (1.11.1)
This library provides an iconv() implementation, for use on systems which don't have one, or whose implementation cannot convert from/to Unicode. . . This piece of software is made available under the terms and conditions of the libiconv license, which can be found below.
Source: <http://ftp.gnu.org/pub/gnu/libiconv>

libmtp (0.3.6)
libmtp is an Initiator implementation of the Media Transfer Protocol (MTP) in the form of a library suitable primarily for POSIX compliant operating systems. We implement MTP Basic, the stuff proposed for standardization.
Source: <http://libmtp.sourceforge.net/>

libjpeg (6b)
This library is used to perform JPEG decoding tasks. This piece of software is made available under the terms and conditions of the libjpeg license, which can be found below.
Source: <http://www.ijg.org/>

libusb
This is the home of libusb, a library that gives user level applications uniform access to USB devices across many different operating systems. libusb is an open source project licensed under the GNU Lesser General Public License version 2.1. Many participants in the libusb community have helped and continue to help with ideas, implementation, support and improvements for

libusb.

This piece of software is made available under the terms and conditions of the libusb license, which can be found below.

Source:

<http://libusb.wiki.sourceforge.net>

<http://www.libusb.org/>

libusb-compat

Library to enable user space application programs to communicate with USB devices.

This piece of software is made available under the terms and conditions of the libusb-compat license, which can be found below.

Source:

<http://libusb.wiki.sourceforge.net/LibusbCompat0.1>

libpng (1.2.43)

libpng -THE reference library for reading, displaying, writing and examining png Image Network Graphics.

This piece of software is made available under the terms and conditions of the libpng license, which can be found below.

Source: <http://sourceforge.net/projects/libpng/files/>

Libxml2 (2.7.8)

The "libxml2" library is used in AstroTV as a support for the execution of NCL application. This library was developed for the GNOME software suite and is available under a "MIT" license.

Source: <http://www.xmlsoft.org>

Linux Kernel (3.1)

The Linux kernel is an operating system kernel used by the Linux family of Unix-like operating systems.

This piece of software is made available under the terms and conditions of the Linux Kernel license, which can be found below.

Source: <http://www.kernel.org>

Linux Fusion (8.7.0)

Source: GNU

liveMedia (2011.06.12)

c++ runtime library for RTSP requirement

Source: www.live555.com

lvm2 (2.02.89)

Userspace toolset that provide logical volume management facilities on linux.

This piece of software is made available under the terms and conditions of the lvm2 license, which can be found below.

Source: <ftp://sources.redhat.com/pub/lvm2/releases/>

module-init-tools (3.12)

Provides developer documentation for the utilities used by Linux systems to load and manage kernel modules (commonly referred to as "drivers").

Source: <https://modules.wiki.kernel.org/index.php/M>

ain_Page

mtd-utils

The aim of the system is to make it simple to provide a driver for new hardware, by providing a generic interface between the hardware drivers and the upper layers of the system. Hardware drivers need to know nothing about the storage formats used, such as FTL, FFS2, etc., but will only need to provide simple routines for read, write and erase. Presentation of the device's contents to the user in an appropriate form will be handled by the upper layers of the system.

This piece of software is made available under the terms and conditions of the mtd-utils license, which can be found below.

Source: <http://www.linux-mtd.infradead.org/index.html>

ncurses (5.7)

The ncurses (new curses) library is a free software emulation of curses in System V Release 4.0 (SVr4), and more. It uses terminfo format, supports pads and color and multiple highlights and forms characters and function-key mapping, and has all the other SVr4-curses enhancements over BSD curses. SVr4 curses is better known today as X/Open Curses.

Source: <http://www.gnu.org/software/ncurses/>

net-tools (1.6)

The Net-tools?package is a collection of programs for controlling the network subsystem of the Linux kernel.

Source: <http://www.linuxfromscratch.org/blfs/view/6.3/basicnet/net-tools.html>

NTFS-3G Read/Write Driver (2010.5.22)

NTFS-3G is an open source cross-platform implementation of the Microsoft Windows NTFS file system with read-write support. NTFS-3G often uses the FUSE file system interface, so it can run unmodified on many different operating systems. It is runnable on Linux, FreeBSD, NetBSD, OpenSolaris, BeOS, QNX, WinCE, Nucleus, VxWorks, Haiku, MorphOS, and Mac OS X It is licensed under either the GNU General Public License or a proprietary license. It is a partial fork of ntfsprogs and is under active maintenance and development.

This piece of software is made available under the terms and conditions of the NTFS-3G Read/Write Driver license, which can be found below.

Source: <http://www.tuxera.com>

openssl (1.0.1j)

OpenSSL is an open source implementation of the SSL and TLS protocols. The core library (written in the C programming language) implements the basic cryptographic functions and provides various utility functions. Wrappers allowing the use of the OpenSSL library in a variety of computer languages are available.

Source: <http://www.openssl.org/>

procps (ps, top) (3.2.8)

procps is the package that has a bunch of small useful utilities that give information about processes using the /proc filesystem.

The package includes the programs ps, top, vmstat, w, kill, free, slabtop, and skill.

Source: <http://procps.sourceforge.net/index.html>

samba (3.0.37)

Samba is the standard Windows interoperability suite of programs for Linux and Unix.

Source: <http://www.samba.org/>

SaWMan (1.5.3)

SaWMan, the Shared application and Window Manager, is a new window manager module for use with DirectFB.

Source: <http://www.directfb.org>

sed (4.1.5)

sed (stream editor) isn't an interactive text editor.

Instead, it is used to filter text, i.e., it takes text input, performs some operation (or set of operations) on it, and outputs the modified text.

sed is typically used for extracting part of a file using pattern matching or substituting multiple occurrences of a string within a file.

Source: <http://www.gnu.org/software/sed/>

SQLite3 (2.12.2)

SQLite is a in-process library that implements a self-contained, serverless, zero-configuration, transactional SQL database engine.

This piece of software is made available under the terms and conditions of the SQLite3 license, which can be found below.

Source: <http://www.sqlite.org/>

SquashFS

SquashFS is a compressed read-only file system for Linux. SquashFS compresses files, inodes and directories, and supports block sizes up to 1 MB for greater compression. SquashFS is also the name of free/open software, licensed under the GPL, for accessing SquashFS filesystems.

This piece of software is made available under the terms and conditions of the SquashFS license, which can be found below.

Source: <http://squashfs.sourceforge.net/>

tar (1.17)

GNU Tar provides the ability to create tar archives, as well as various other kinds of manipulation.

For example, you can use Tar on previously created archives to extract files, to store additional files, or to update or list files which were already stored.

Source: <http://www.gnu.org/software/tar/>

u-Boot (2011.12)

The uboot will load the linux kernel to dram, and jump

to run .

This piece of software is made available under the terms and conditions of the u-Boot loader license, which can be found below.

Source: <http://www.denx.de>

udhcpc (0.9.8cvs20050303-3)

Source: <http://udhcp.sourceforge.com/downloads/0.9.8cvs20050303-3/>

uDirectFB (1.5.3)

Source: <http://www.directfb.org>

uriparser (0.7.7)

Uriparser is a strictly RFC 3986 compliant URI parsing and handling library written in C. uriparser is cross-platform, fast, supports Unicode and is licensed under the New BSD license.

Source: <http://uriparser.sourceforge.net/>

util-linux-ng (2.18)

Various system utilities.

Source: <http://userweb.kernel.org/~kzak/util-linux-ng/>

wget (1.10.2)

GNU Wget is a free software package for retrieving files using HTTP, HTTPS and FTP, the most widely-used Internet protocols.

It is a non-interactive commandline tool, so it may easily be called from scripts, cron jobs, terminals without X-Windows support, etc.

Source: <http://ftp.gnu.org/gnu/wget/wget-1.10.2.tar.gz>

wpa_supplicant v0.8(wext)/v2.3(cfg80211)

wpa_supplicant is a WPA Supplicant for Linux, BSD, Mac OS X, and Windows with support for WPA and WPA2 (IEEE 802.11i / RSN). It is suitable for both desktop/laptop computers and embedded systems. Supplicant is the IEEE 802.1X/WPA component that is used in the client stations. It implements key negotiation with a WPA Authenticator and it controls the roaming and IEEE 802.11

authentication/association of the wlan driver.

Source: https://w1.fi/wpa_supplicant/

xerces-c++ (3.1.1)

Source: <http://xerces.apache.org/>

zlib (6b)

The 'zlib' compression library provides in-memory compression and decompression functions, including integrity checks of the uncompressed data.

This piece of software is made available under the terms and conditions of the zlib license, which can be found below.

Source: <http://www.zlib.net/>

Disclaimer regarding services and/or software offered by third parties

Services and/or software offered by third parties may be changed, suspended, or terminated without prior notice. TP Vision does not bear any responsibility in these sorts of situations.

Index

A

Advanced Picture Settings 29
Advanced Sound Settings 32
App Gallery 41
App lock 37
Audio Language 36
Audio Out Menu 32
Auto Clock Mode 36

B

Batteries 6

C

Channel List 18
Channel List Copy 16
Channel Options 17
Channel, Channel Filter 19
Channel, Rename Channel 18
Channels 15
Child Lock 37
Child Lock, Change Code 37
Child Lock, Set Code 37
Clear dialogue 32
Clear Internet Memory 39
Clock 36
Colour 29
Colour Enhancement 29
Colour Settings 29
Colour Temperature 29
Composite / CVBS 10
Connect Device 10
Connection - Antenna 10
Connection - Power Cable 8
Consumer Care 3
Contact Info 3
Contrast 29

D

Date 36
Dialogue enhancement 37
Digital Audio Out 11
Digital Media Renderer - DMR 39
Digital Out Delay 33
Digital Out Format 33
Digital Out Levelling 33
Digital Out Menu 33
Digital Out Offset 33
Dynamic Contrast 30

E

End of Use 46
Energy Saving 34
Equalizer 32

F

Favourite Channel, Channel Range 19
Favourite Channel, Create 19
Favourite Channel, Edit 19
Favourite Channels 19
Flash Drive 12

G

Gamma 30

General Settings 33
Get Support 3

H

HbbTV 33
HDMI 10
HDMI - ARC 10
HDMI - CEC 34
HDMI Sound System 32
HDMI Ultra HD 34
HDR 30
Headphone 11
Headphones 32
Help Menu 3
Home Menu 28
Home or Shop 35

I

Identify TV 3
Input Resolution 47
Install Channel - Antenna 15

K

Keys on TV 7

L

Location 35
Lock Channel 19

M

Menu Languages 36
Miracast 11
Miracast Connection 11
Mouse Settings 34
Multimedia 48

N

Netflix Settings 39
Network - Wired 38
Network - Wireless 38
Network Settings 38
Network Settings Menu 39

O

On-line User Manual 3

P

Parental Rating 37
Pause TV 25
Philips Support 3
Philips TV Remote App 12
Photos, Videos and Music 26
Picture Clean, Noise Reduction 30
Picture Contrast Menu 30
Picture Contrast Mode 30
Picture Format 31
Picture Motion 31
Picture Motion Style 31
Picture Style 28
Picture, Colour 29
Picture, Contrast 29
Picture, Sharpness 29
Postal code 37
Problems 49

Q

Quick Picture Settings 31
Quick Settings Menu 28

R

Recordings 24
Register TV 3
Remote Control 6
Remote Control - IR Sensor 7
Remote Control and Batteries 6
Remote Control Key 6
Rename or replace device icon 14
Repair 3
Reset Settings 36

S

Safety and Care 53
Screen Off 34
Sharpness 29
Shop Setup 35
Sleep Timer 36
Smart TV 41
Software Version 5
Sound Menu 31
Sound Style 31
Sound, Auto Volume Levelling 32
Sound, Delta Volume 32
Source List 14
Standby Mode 9
Static IP 39
Subtitle Language 36
Switch Off Timer 34
Switch On with Wi-Fi 39
Switching On 9

T

Teletext 20
Text 20
Time 36
Time Zone 36
Troubleshooting 49
TV Guide 22
TV Network Name 39
TV Placement 32
TV Reception 47
TV Speaker 32

U

Ultra resolution 30
Universal Access 37
Universal Access, Audio Description 37
Universal Access, Audio Effects 37
Universal Access, Hearing Impaired 37
Universal Access, Mixed Volume 37
Universal Access, Speech 37
Unlock Channel 19
Update Software 5
Update Software - Internet 5
Update Software - Local Updates 5
Update Software - OAD 5
Update Software - USB 5
USB Hard Drive 33
USB Hard Drive - Format 13
USB Hard Drive - Install 12
USB Hard Drive Connection 12
USB Keyboard Settings 34
User Manual 3

V

Video Contrast 30
Video on Demand 42
View Network Settings 39
Viewing Distance 8

W

Wi-Fi 39



All registered and unregistered trademarks are property of their respective owners.
Specifications are subject to change without notice.
Philips and the Philips' shield emblem are trademarks of Koninklijke Philips N.V.
and are used under license from Koninklijke Philips N.V.
2019 © TP Vision Europe B.V. All rights reserved.

philips.com